

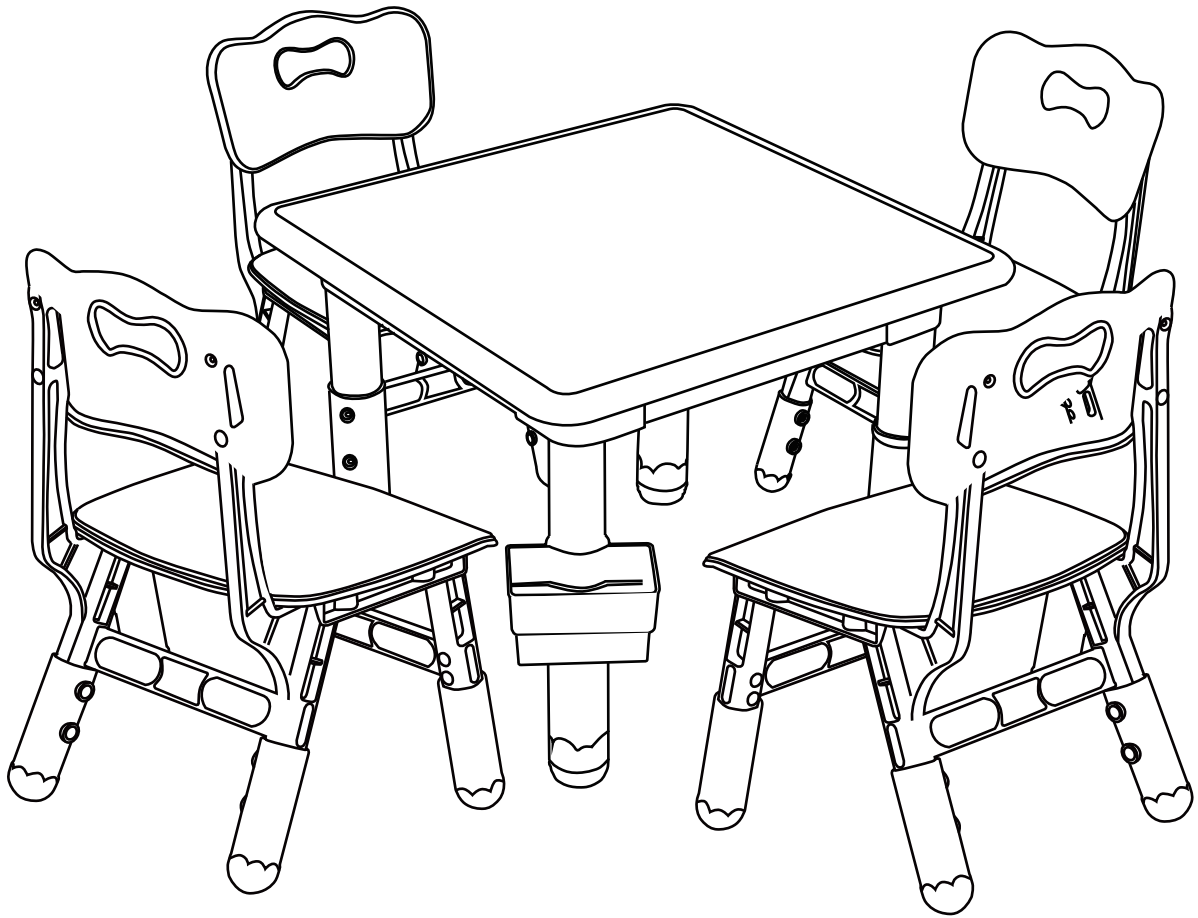

IN240300280V01_US_CA

312-120V81



ASSEMBLY INSTRUCTION INSTRUCTIONS D'ASSEMBLAGE

EN: Certification Age: 18+ months;
Maximum Weight Capacity of Chair: 50 Kg/seat; Table: 50 Kg.

FR: Âge de certification: 18+ mois;
Poids maximum admissible de la chaise: 50 Kg/siège; Table: 50 kg.

**EN: IMPORTANT, RETAIN FOR FUTURE REFERENCE: READ CAREFULLY.
FR: IMPORTANT: A LIRE ATTENTIVEMENT ET A CONSERVER POUR VOUS Y
REFRERER ULTERIEUREMENT**

EN

IMPORTANT! READ CAREFULLY AND KEEP FOR FUTURE REFERENCE.

WARNING:

1. CHOKING HAZARD—Small parts. Not for children under 3 years.
2. Only allowed for adults to install, keep children away.
3. To be used under the direct supervision of an adult.
4. Place it on a flat and clean floor, Check all the parts are well connected before use.
5. DO NOT place this product near a window as it can be used as a step by the child and cause the child to fall out of the window.
6. Be aware of the risk of open fires and other sources of strong heat in the vicinity of the product.
7. DO NOT place this product near a window where cords from blinds or curtains could strangle a child.
8. DO NOT to use the seating if any part is broken, torn or missing and use only spare parts approved by the manufacturer.

MAINTENANCE & CARE

- A. Keep all instructions and parts relating to this product for future reference.
- B. Please wipe down with a dry or damp cloth.

FR

IMPORTANT! LIRE ATTENTIVEMENT ET CONSERVER POUR RÉFÉRENCE ULTÉRIEURE.

ATTENTION

1. RISQUE D'ÉTOUFFEMENT - Petites pièces. Déconseillé aux enfants de moins de 3 ans.
2. Installation par des adultes uniquement, tenir les enfants à l'écart.
3. À utiliser sous la surveillance directe d'un adulte.
4. Posez-le sur un sol plat et propre. Vérifiez que toutes les pièces sont bien connectés avant toute utilisation.
5. NE PAS placer ce produit près d'une fenêtre ; il pourrait être utilisé comme marchepied par un enfant et le faire tomber par la fenêtre.
6. Soyez conscient du risque de feu ouvert et d'autres sources de forte chaleur à proximité du produit.
7. NE PAS placer ce produit près d'une fenêtre où les cordons des stores ou des rideaux pourraient étrangler un enfant.
8. NE PAS utiliser le siège si une pièce est cassée, déchirée ou manquante et n'utiliser que des pièces de rechange approuvées par le fabricant.

ENTRETIEN ET MAINTENANCE

- A. Conservez toutes les instructions et les pièces relatives à ce produit pour pouvoir vous y référer ultérieurement.
- B. Veuillez essuyer avec un chiffon sec ou humide.

A

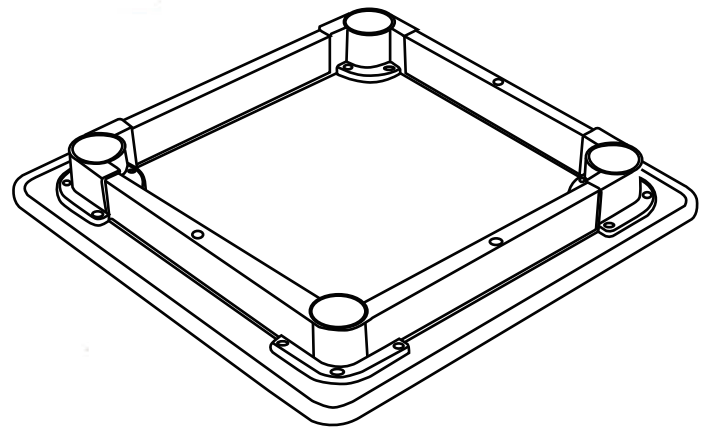

Bx4



Cx4

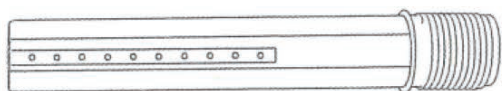

Dx4

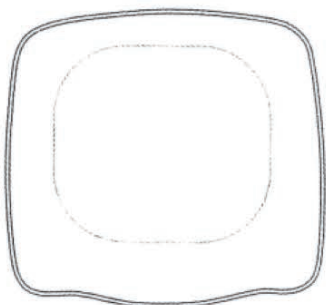

Ex4

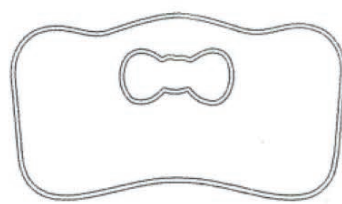

Fx8

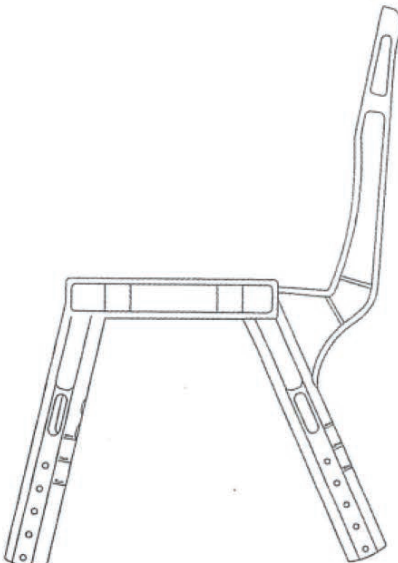

Gx16

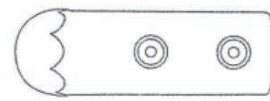

Hx8

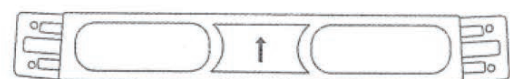

Ix96 +8(spare)



Jx1

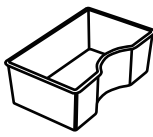

Kx1

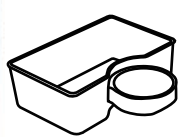

A x 1

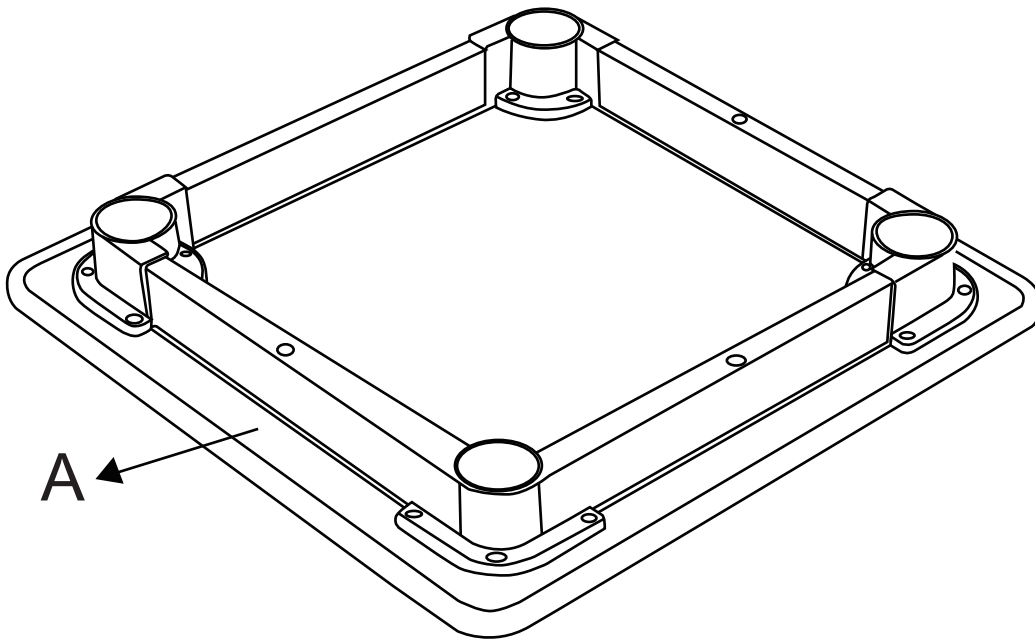

C x 4

K x 1

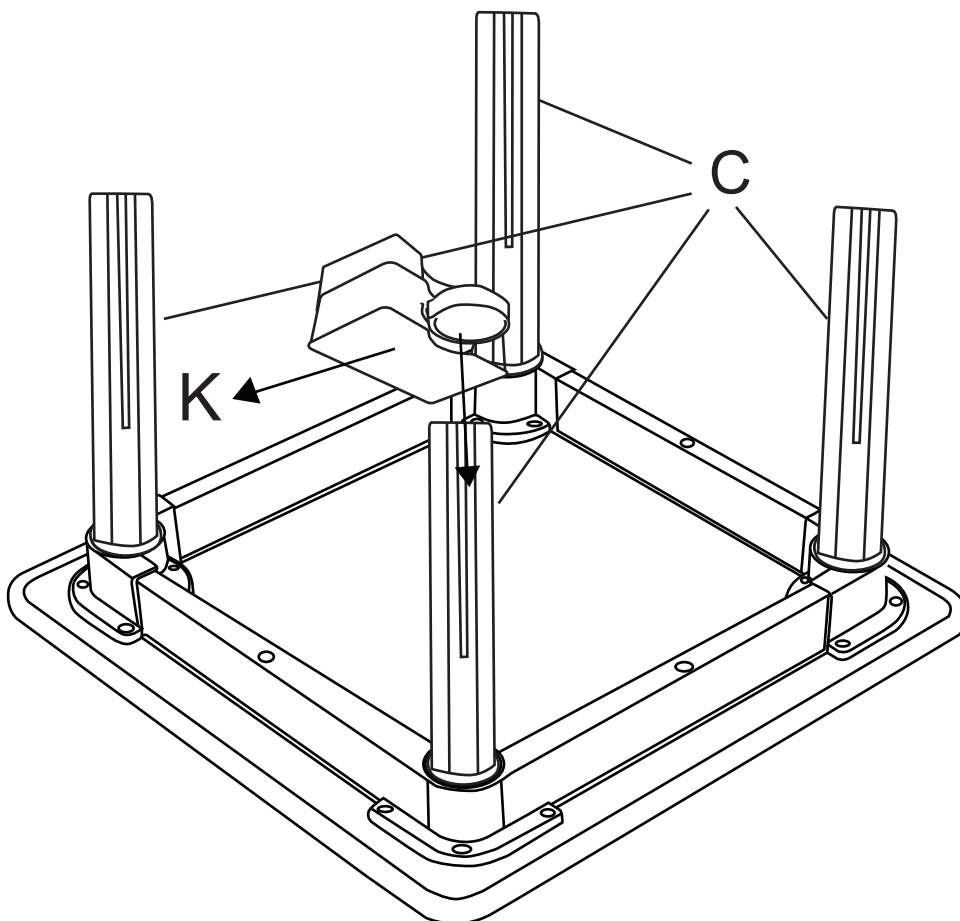

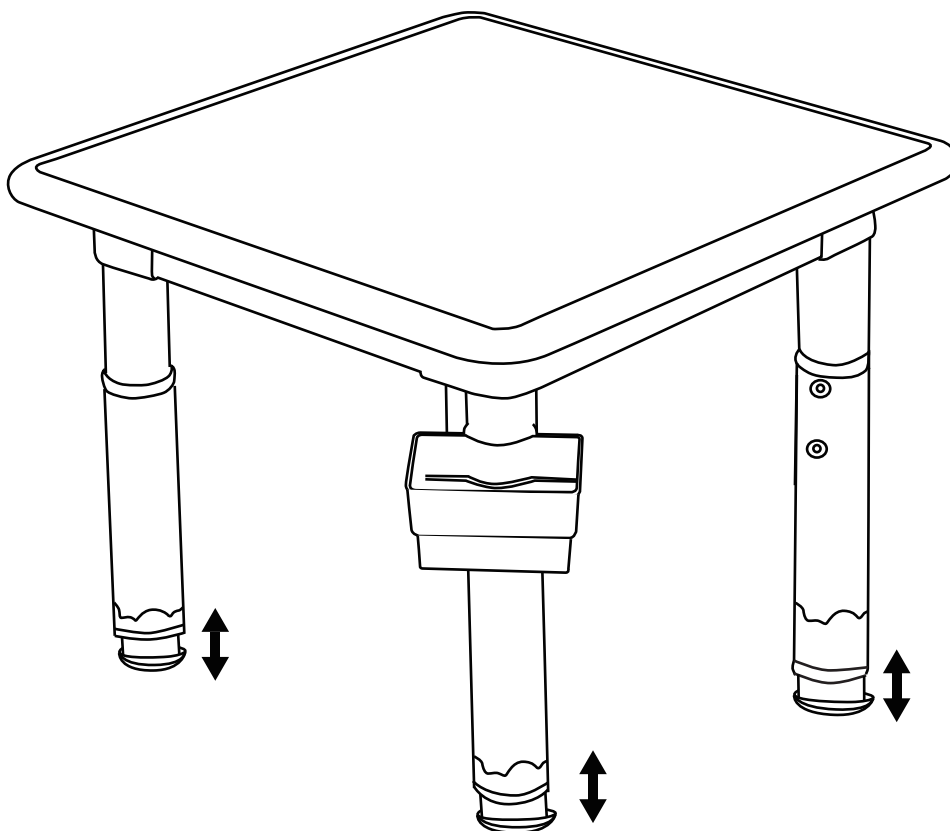
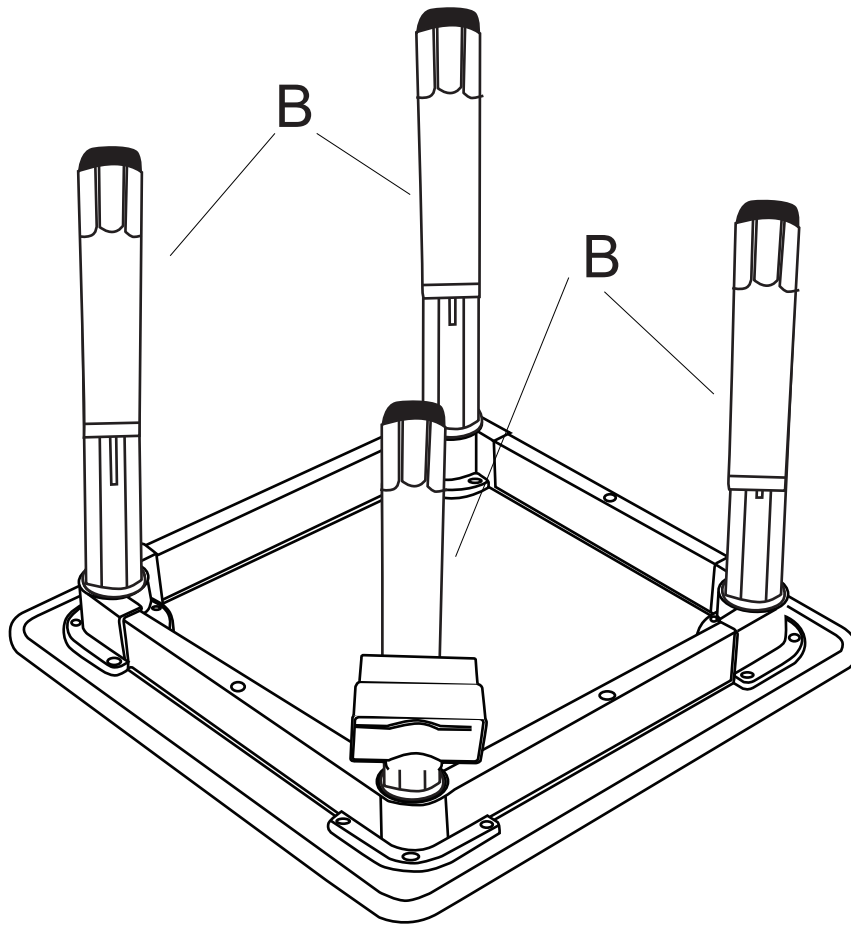

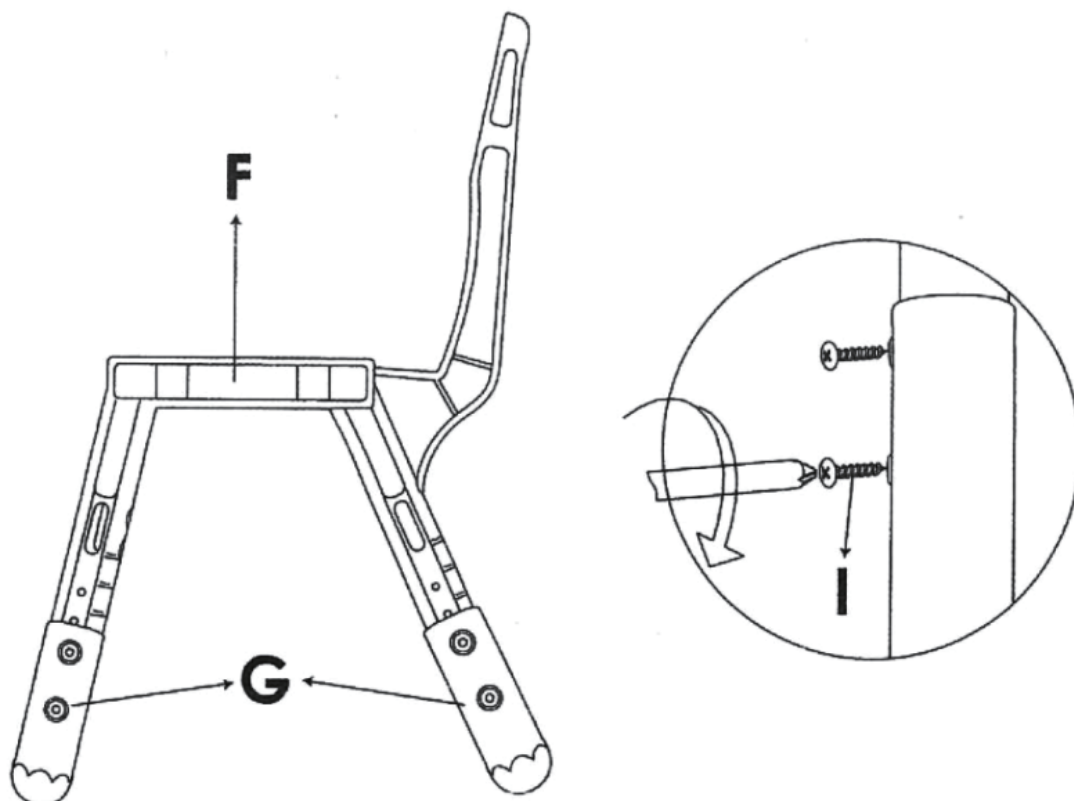
F x 8**G** x 16**I** x 32

x8

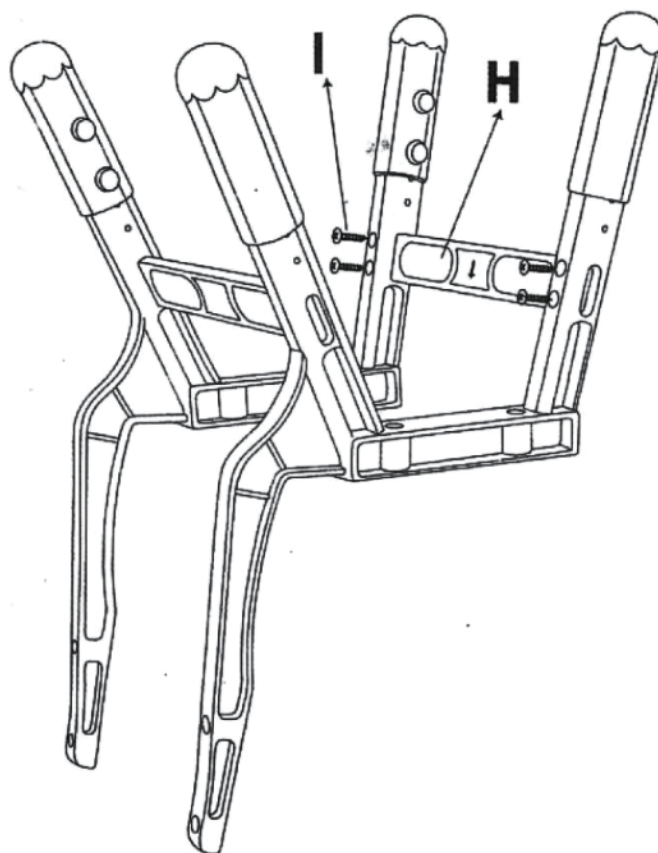
H x 8**I** x 32

x4

D x 4

I x 16

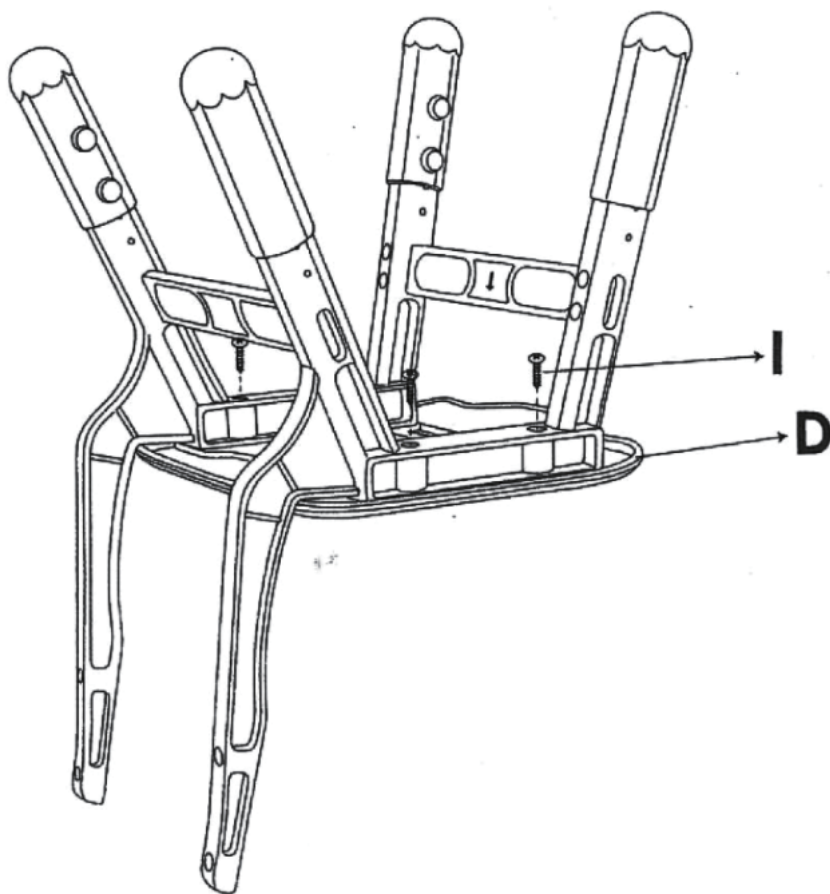

x4

E x 4

I x 16

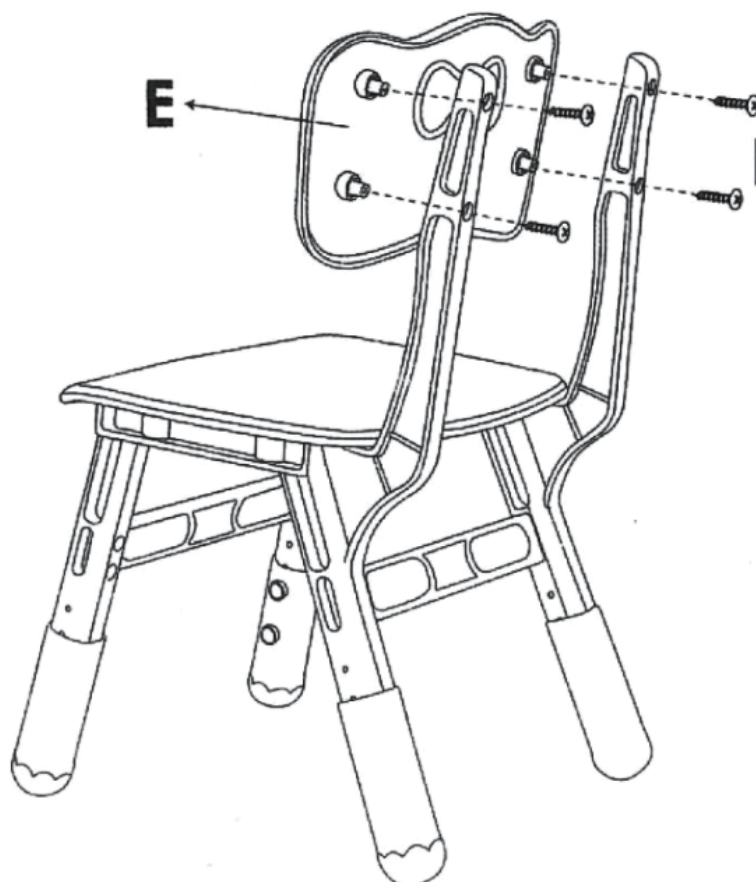

Done

x4

US

If you have any questions, please contact our customer care center.
Our contact details are below:



001-877-644-9366



customerservice@aosom.com

Imported by Aosom LLC
27150 SW Kinsman Rd Wilsonville, OR 97070 USA
MADE IN CHINA

CA

If you have any questions, please contact our customer care center.
Our contact details are below:

Si vous avez la moindre question, veuillez contacter notre centre d'assistance à la clientèle.
Nos coordonnées sont les suivantes:



416-792-6088



customerservice@aosom.ca

Imported by Aosom Canada Inc.
7270 Woodbine Avenue, Unit 307, Markham, Ontario Canada
L3R 4B9
MADE IN CHINA

Importé par Aosom Canada Inc.
7270 Woodbine Avenue, unité 307, Markham, Ontario Canada
L3R 4B9
FABRIQUÉ EN CHINE