



IN240500004V01_US_CA

350-169V01



ASSEMBLY INSTRUCTION INSTRUCTIONS D'ASSEMBLAGE

EN: **WARNING:** Assembly by an adult.

Suitable for children of 3+ years old.

FR: **ATTENTION:** Assemblage par un adulte.

Convient aux enfants de 3+ ans.

EN: IMPORTANT, RETAIN FOR FUTURE REFERENCE: READ CAREFULLY.

FR: IMPORTANT: A LIRE ATTENTIVEMENT ET A CONSERVER POUR VOUS Y REFRENER ULTERIEUREMENT

WARNING:

1. CHOKING HAZARD—Small parts. Not for children under 3 years.
2. Only allowed for adults to install, keep children away.
3. To be used under the direct supervision of an adult.
4. Keep away from fire! Keep away from water!

MAINTENANCE & CARE

- A. Keep all instructions and parts relating to this product for future reference.
- B. If any problem occurred, please sent it to qualified maintainer.
- C. Clean your toy with a clean damp cloth.

BATTERY WARNING:

1. Do not mix alkaline, standard or rechargeable batteries.
2. Never mix old and new batteries.
3. Batteries are to be inserted with the correct polarity.
4. Remove the batteries when the unit is not in use for long periods.
5. Always comply with local laws and regulations.

ATTENTION

1. RISQUE D'ÉTOUFFEMENT - Petites pièces. Déconseillé aux enfants de moins de 3 ans.
2. Installation par des adultes uniquement, tenir les enfants à l'écart.
3. À utiliser sous la surveillance directe d'un adulte.
4. Loin du feu ! Loin de l'eau !

ENTRETIEN ET MAINTENANCE

- A. Conservez toutes les instructions et les pièces relatives à ce produit pour pouvoir vous y référer ultérieurement.
- B. Si un problème survient, veuillez l'envoyer à un technicien qualifié.
- C. Nettoyez votre jouet avec un chiffon propre et humide.

AVIS RELATIF AUX PILES :

1. Ne pas mélanger les piles alcalines, standard ou rechargeables.
2. Ne mélangez jamais des piles anciennes avec de nouvelles piles.
3. Les piles doivent être insérées avec la bonne polarité.
4. Retirez les piles lorsque l'appareil n'est pas utilisé pendant une longue période.
5. Respectez toujours les lois et règlements locaux.

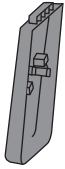

① x 1

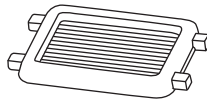

② x 1



③ x 1

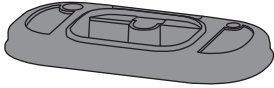

④ x 1

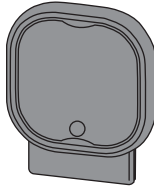

⑤ x 1



⑥ x 3



⑦ x 2



⑧ x 1



⑨ x 1



⑩ x 1



⑪ x 2



⑫ x 1



⑬ x 1



⑭ x 1



⑮ x 1

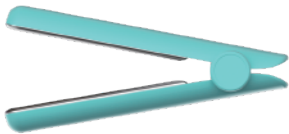

⑯ x 1

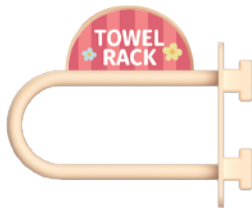

⑰ x 1



⑱ x 1



⑲ x 1



⑳ x 2



㉑ x 1



㉒ x 1

01

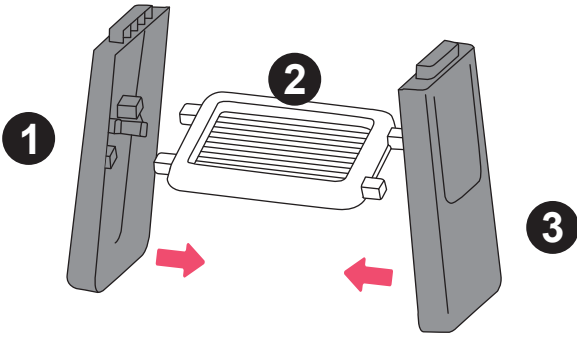

02

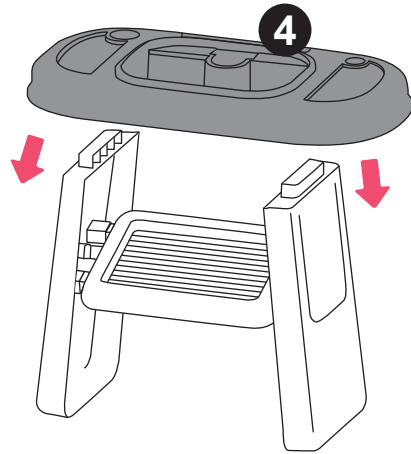

03

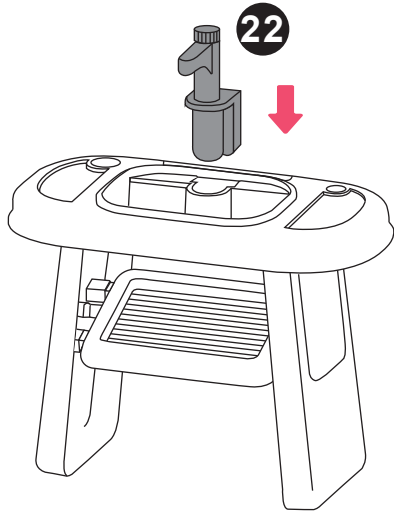

04

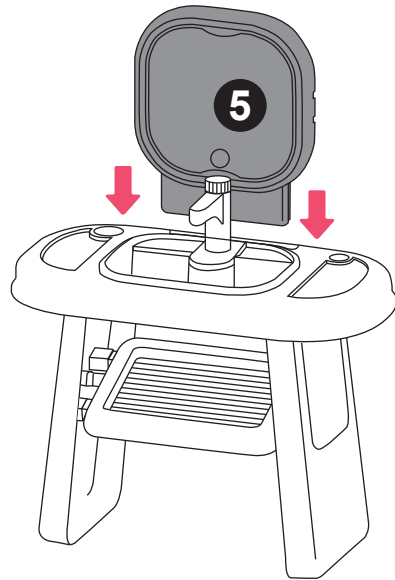

05

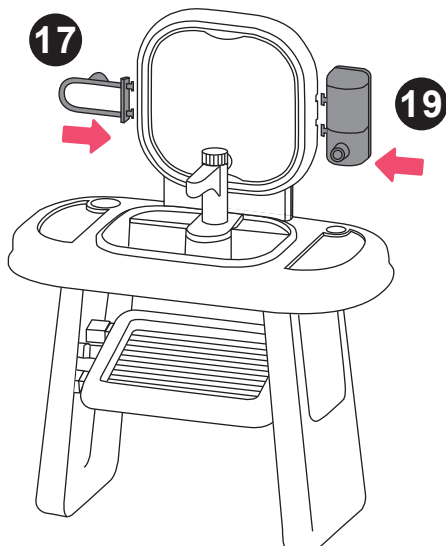

06

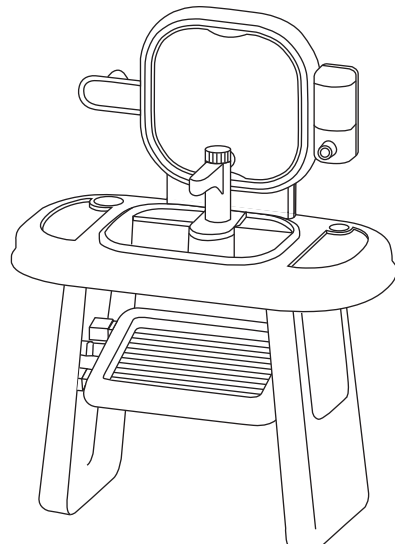



US

If you have any questions, please contact our customer care center.
Our contact details are below:



001-877-644-9366



customerservice@aosom.com

Imported by Aosom LLC
27150 SW Kinsman Rd Wilsonville, OR 97070 USA
MADE IN CHINA

CA

If you have any questions, please contact our customer care center.
Our contact details are below:

Si vous avez la moindre question, veuillez contacter notre centre d'assistance à la clientèle.
Nos coordonnées sont les suivantes:



416-792-6088



customerservice@aosom.ca

Imported by Aosom Canada Inc.
7270 Woodbine Avenue, Unit 307, Markham, Ontario Canada
L3R 4B9
MADE IN CHINA

Importé par Aosom Canada Inc.
7270 Woodbine Avenue, unité 307, Markham, Ontario Canada
L3R 4B9
FABRIQUÉ EN CHINE