



USER MANUAL

AA0-077 EN C000000

1. GENERAL DESCRIPTION

The user manual is designed to assist in the safe and trouble-free use of the device. The product is designed and manufactured in accordance with strict technical guidelines, using state-of-the-art technologies and components. Additionally, it is produced in compliance with the most stringent quality standards.

DO NOT USE THE DEVICE UNLESS YOU HAVE THOROUGHLY READ AND UNDERSTOOD THIS USER MANUAL.

To increase the product life of the device and to ensure trouble-free operation, use it in accordance with this user manual and regularly perform maintenance tasks. The technical data and specifications in this user manual are up to date. The manufacturer reserves the right to make changes associated with quality improvement.

The maximum load is 5KG, must not be exceeded.

LEGEND



Read instructions before use.



WARNING! or CAUTION! or REMEMBER!
Applicable to the given situation (general warning sign).



PLEASE NOTE! Drawings in this manual are for illustration purposes only and in some details may differ from the actual product.

The original operation manual is written in German. Other language versions are translations from the German.

2. USAGE SAFETY



ATTENTION! Read all safety warnings and all instructions. Failure to follow the warnings and instructions may result in electric shock, fire and/or serious injury or even death.

The terms "device" or "product" are used in the warnings and instructions to refer to <Motorcycle top case>.

- Keep packaging elements and small assembly parts in a place not available to children.
- Repair and maintenance of the product should only be carried out by qualified staff, using original spare parts only. This will ensure safety of use.
- Do not change the product design or parameters.
- Keep the product away from sources of fire and heat.
- During the ride, the case should be always firmly fixed to the luggage rack and locked.
- The maximum load on the product, as quoted in the technical data table which is part of this document, must not be exceeded.



ATTENTION! Despite the safe design of the device and its protective features, and despite the use of additional elements protecting the operator, there is still a slight risk of accident or injury when using the device. Stay alert and use common sense when using the device.

3. USE GUIDELINES

The product is intended for transporting and storing objects with weight and dimensions not exceeding the parameters quoted in the technical data table.

3.1. DEVICE DESCRIPTION

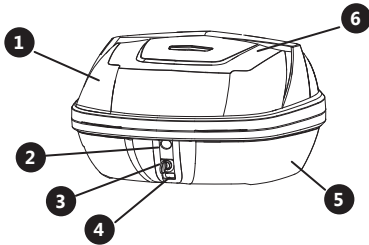





1. Reflective elements
2. Safety element
3. Key lock
4. Locking button
5. Lower part of the case
6. Top cover of the case

3.2. ASSEMBLY

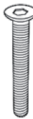
The product should be always firmly fixed to the motorcycle luggage rack, as shown in the assembly instructions.

List of elements

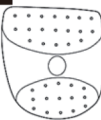
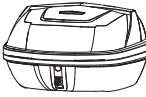
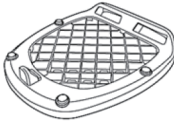
A	4x	B	4x	C	4x
					
D	4x	E	4x	F	1x
					
G	1x	H	1x		
					

Assembly instructions

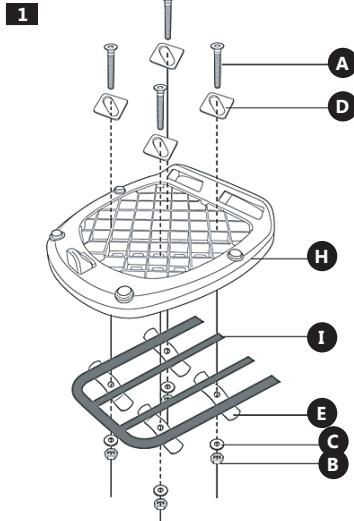

PLEASE NOTE: The case fixing element (I) shown in the assembly diagram is not part of the motorcycle top case set.

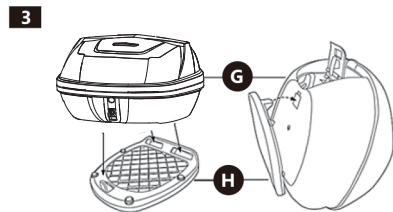
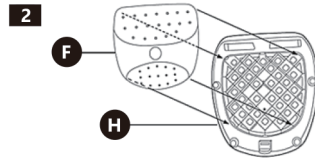

3.3. DIRECTIONS FOR USE

- To lift the case off the luggage rack, open the key lock, then push the locking button and lift the case up.
- To open the case top cover, open the key lock, and then lift the safety element up slightly and then open the case top cover.

3.4. CLEANING AND MAINTENANCE

- a) Use only non-corrosive cleaners to clean the surface.
- b) Store the unit in a dry, cool place, free from moisture and direct exposure to sunlight.
- c) Use a soft, damp cloth for cleaning.