

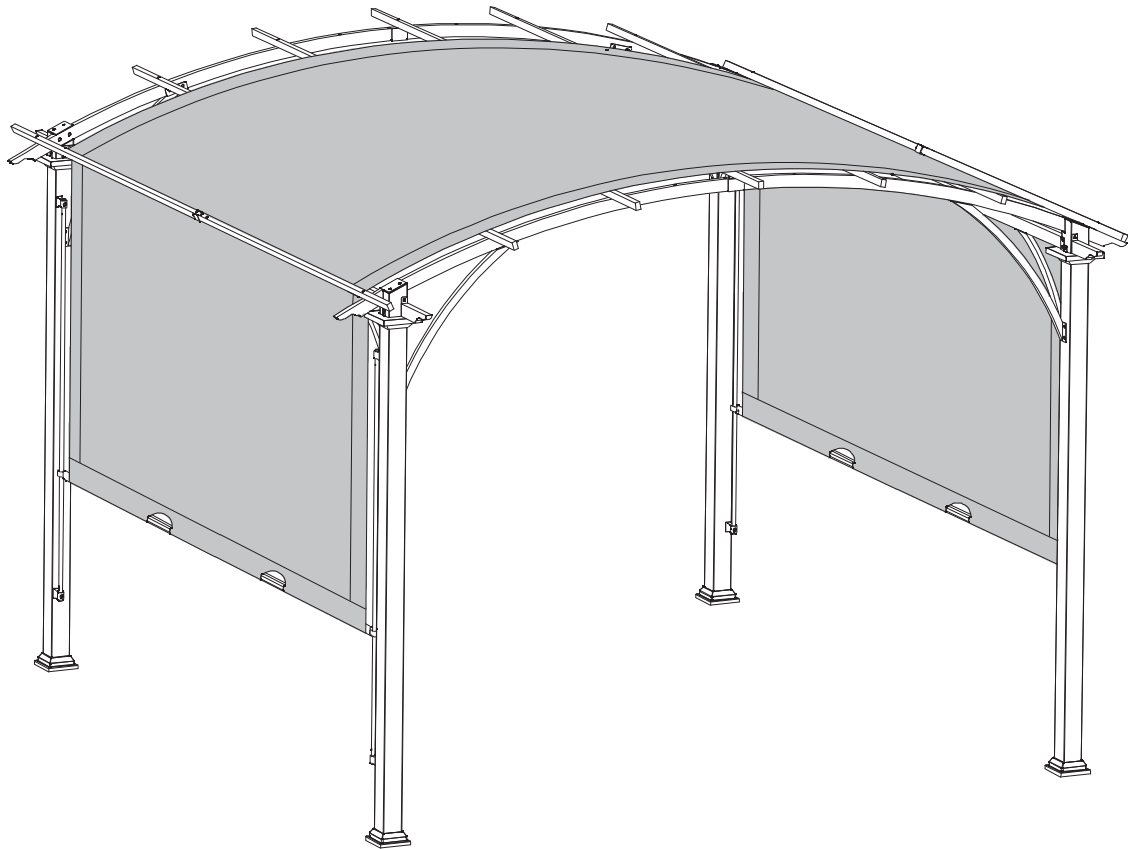

INbac003_DE

84C-243_84C-243V01



















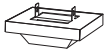

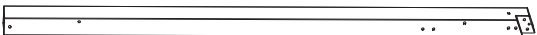



READ AND SAVE THIS INSTRUCTIONS FOR FUTURE USE







ASSEMBLY & INSTRUCTION MANUAL

Warnhinweise:

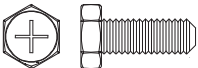
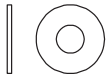

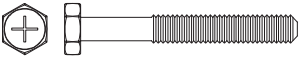
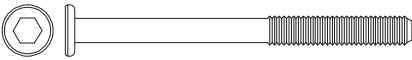

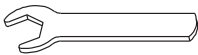
1. Bauen Sie das Zelt mit Hilfe von 3 Personen auf.
2. Stellen Sie das Zelt auf einen ebenen Untergrund auf und achten Sie darauf, dass sich keine offenen Feuerstellen in der Nähe befinden.
3. Um Beschädigungen des Zeltes zu vermeiden, benützen Sie es bitte nicht bei schlechten Wetterbedingungen wie starkem Regen, Wind oder Schneefällen. Für Schäden aufgrund schlechter Witterungsverhältnisse wird keine Haftung und Gewährleistung übernommen.
4. Bei Schneefall darf die Schneehöhe auf dem Dach 5 cm nicht überschreiten. Es obliegt Ihrer Verantwortung, das Zelt rechtzeitig und vorsichtig von der Schneelast zu befreien.
5. Sollten sich bei starkem Regen Wassertaschen auf dem Dach bilden, obliegt es Ihrer Verantwortung diese rechtzeitig und vorsichtig zu beseitigen.
6. Achten Sie beim Verstauen des Zeltes darauf alle Teile, insbesondere die Plane, vorher zu säubern und erst in trockenem Zustand einzupacken. Lagern Sie das Zelt an einem trockenen Ort.
7. Prüfen Sie vor Wiederaufbau des Zeltes die Vollständigkeit und Funktionalität aller für den Aufbau benötigten Teile.

	Description	Sketch	QTY
A1	Roof Tube A1		7 pcs
A2	Roof Tube A2		7 pcs
B1	Roof Tube Curved B1		2 pcs
B2	Roof Tube Curved B2		2 pcs
B3	Connector B3		2 pcs
C1	Lintel C1		2 pcs
C2	Lintel C2		2 pcs
D	Decoration for Post		4 pcs
D4	Top Cover for Post		4 pcs
E	Post E		2 pcs
F	Post F		2 pcs
G	Base Plate		4 pcs
H	Base Plate Cover		4 pcs
I1	Corner Brace I1		2 pcs
I2	Corner Brace I2		2 pcs
J1	Corner Brace J1		2 pcs
J2	Corner Brace J2		2 pcs
L	Connector L		8 pcs

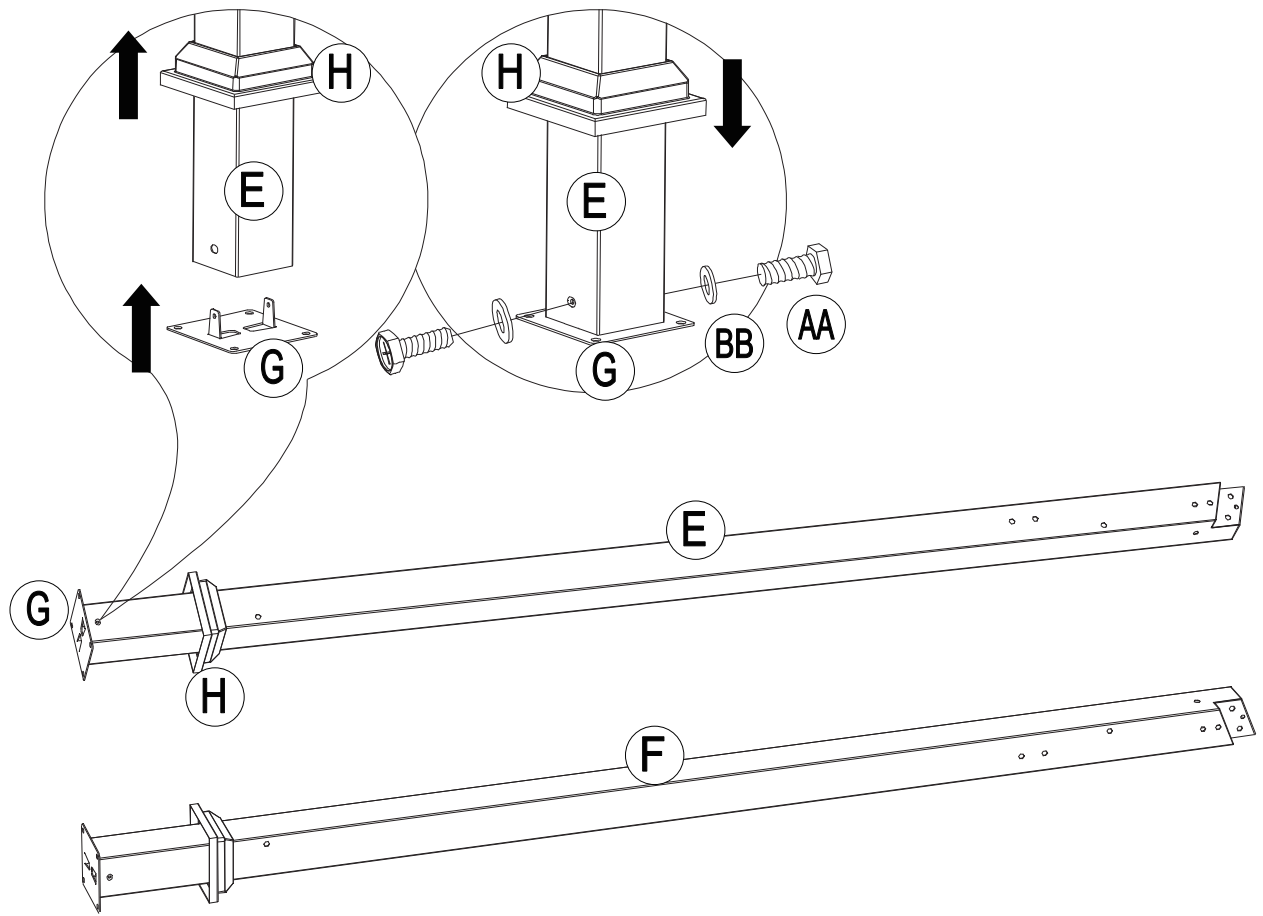

	Description	Sketch	QTY
M	Weight Bar M		2 pcs
N	Weight Bar N		2 pcs
O	Guide Tube		4 pcs
P	Shade Fabric		1 pc

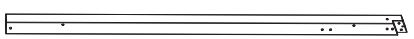
	Description	Sketch	QTY
AA	Bolt M6*15		5 pcs
BB	Bolt M6		7 pcs
CC	Bolt M6*15		1 pc
DD	Bolt M6*45		2 pcs
EE	Bolt M6*70		1 pcs
FF	Anchor FF $\Phi 6*230$		0
Z1	Wrench M6		0
Z2	Anchor Z2 M6		0

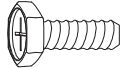

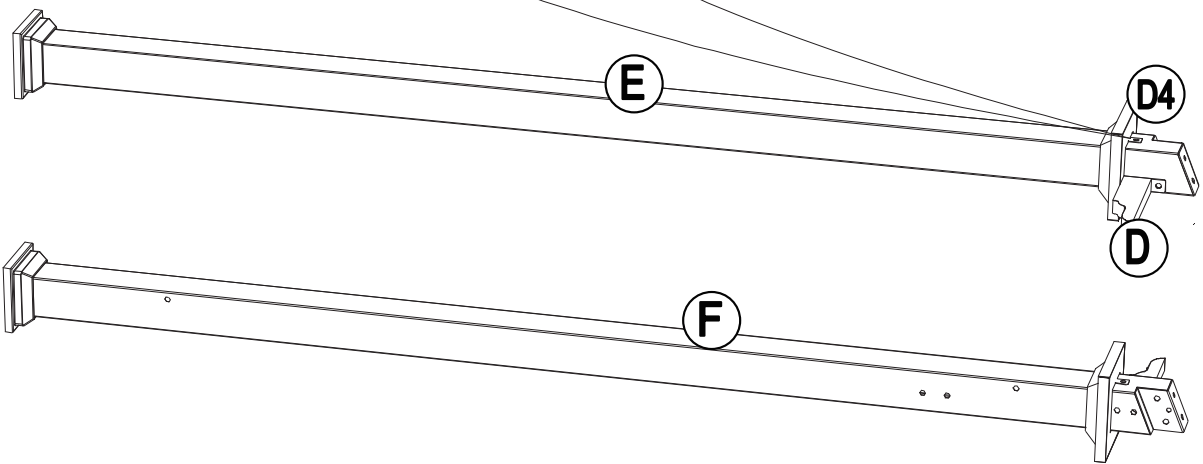
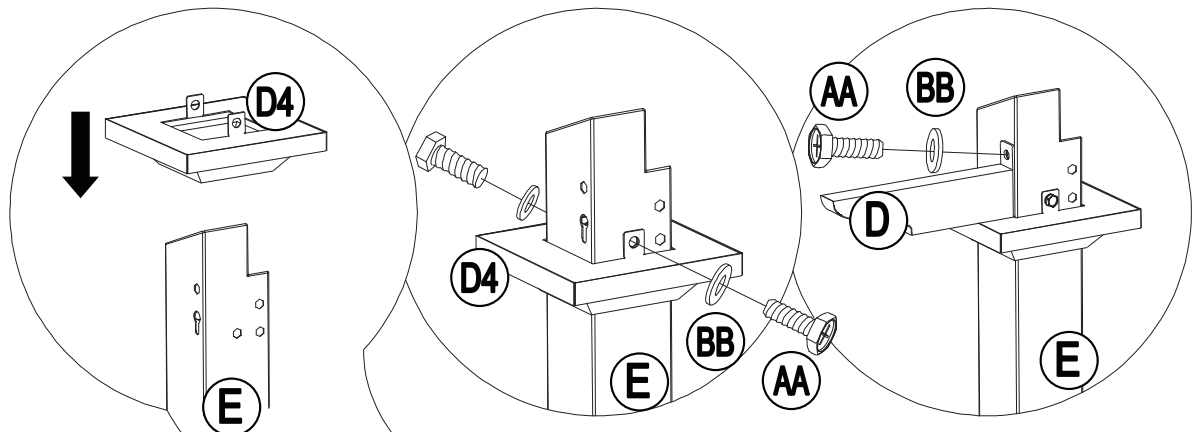

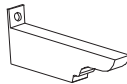
	E x 2pcs		G x 4pcs
	F x 2pcs		BB x 8pcs
	H x 4pcs		AA x 8pcs

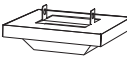
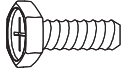

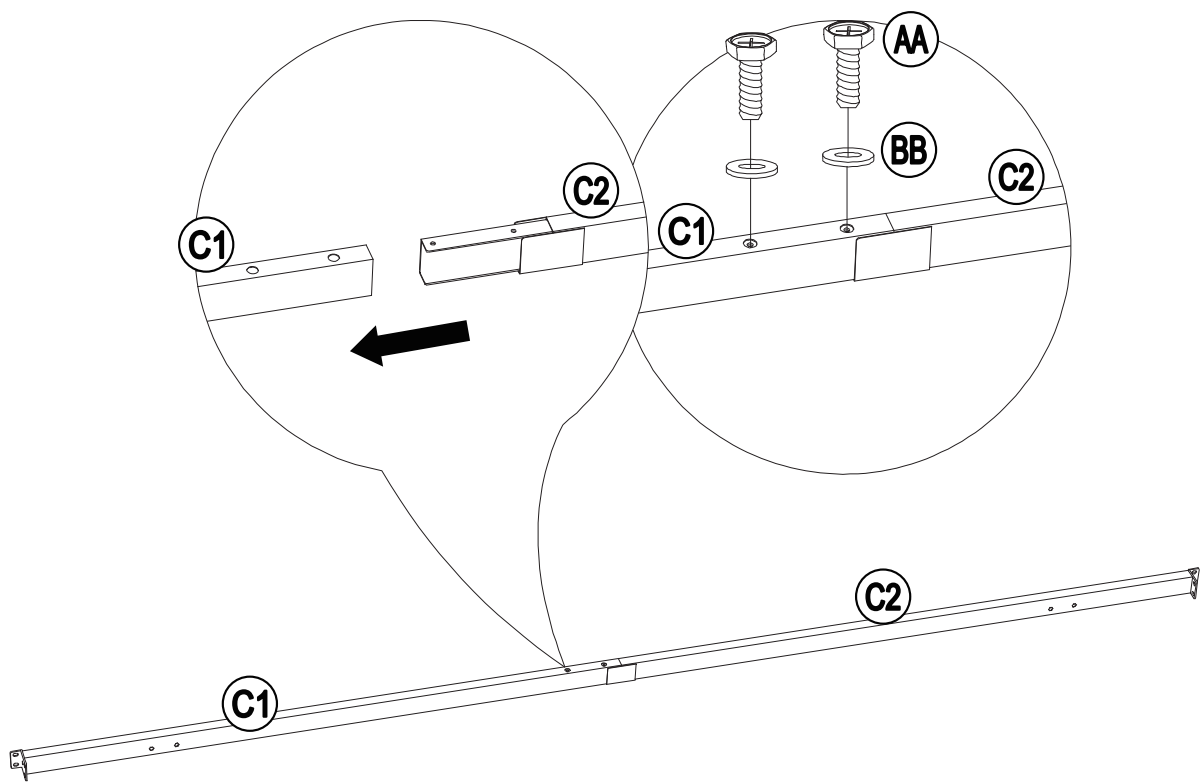
	<p>D x 4pcs</p>		<p>BB x 12pcs</p>
	<p>D4 x 4pcs</p>		<p>AA x 12pcs</p>



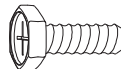

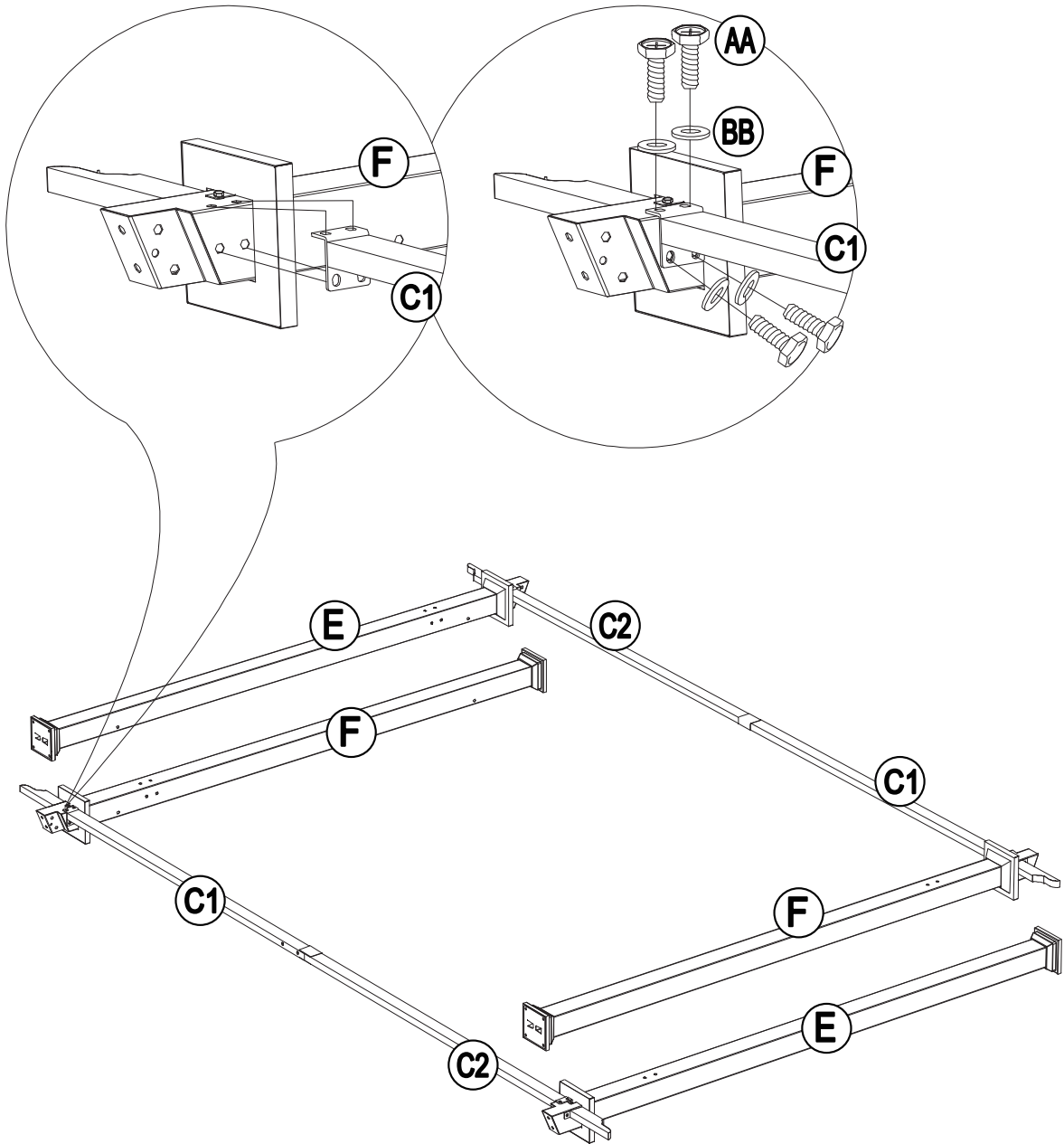
 C2 x 2pcs	 BB x 4pcs
 C1 x 2pcs	 AA x 4pcs

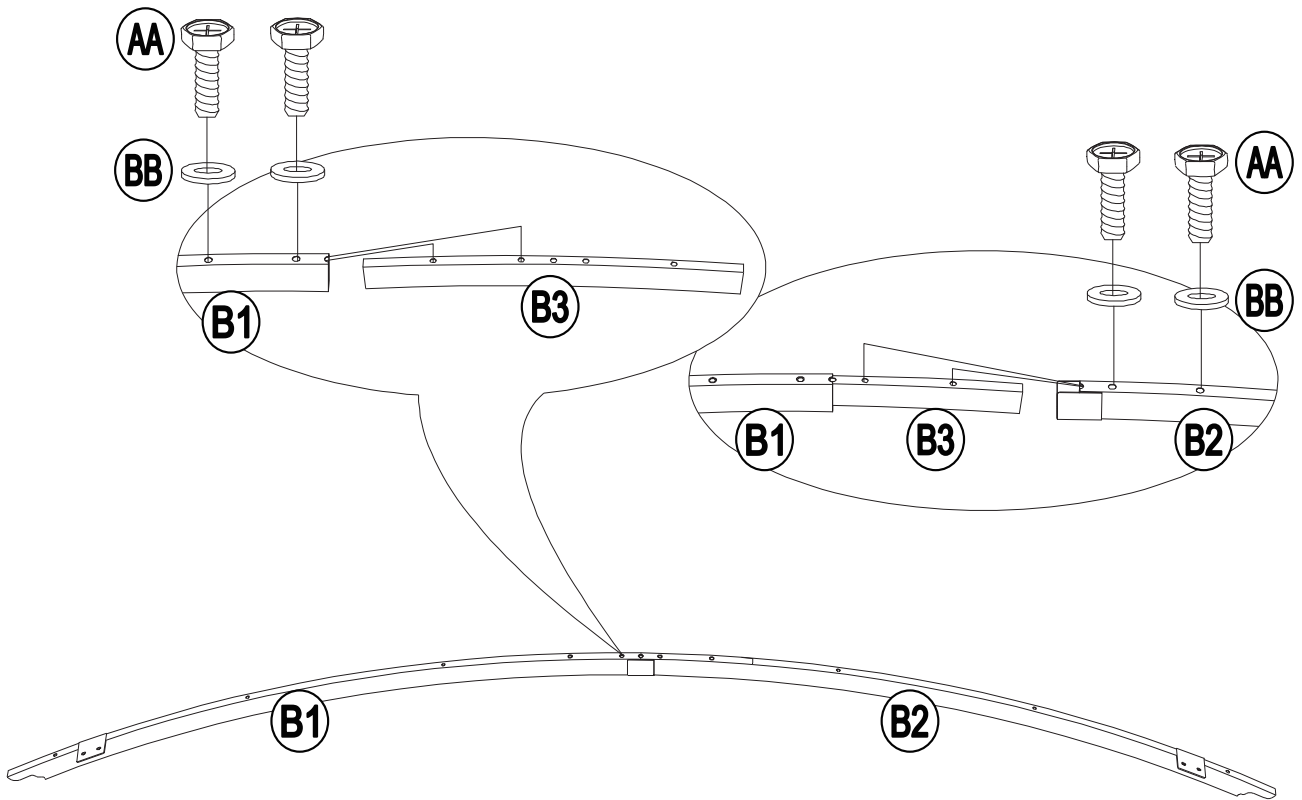

	BB x 16pcs		AA x 16pcs
---	------------	--	------------



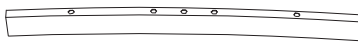
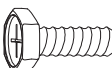

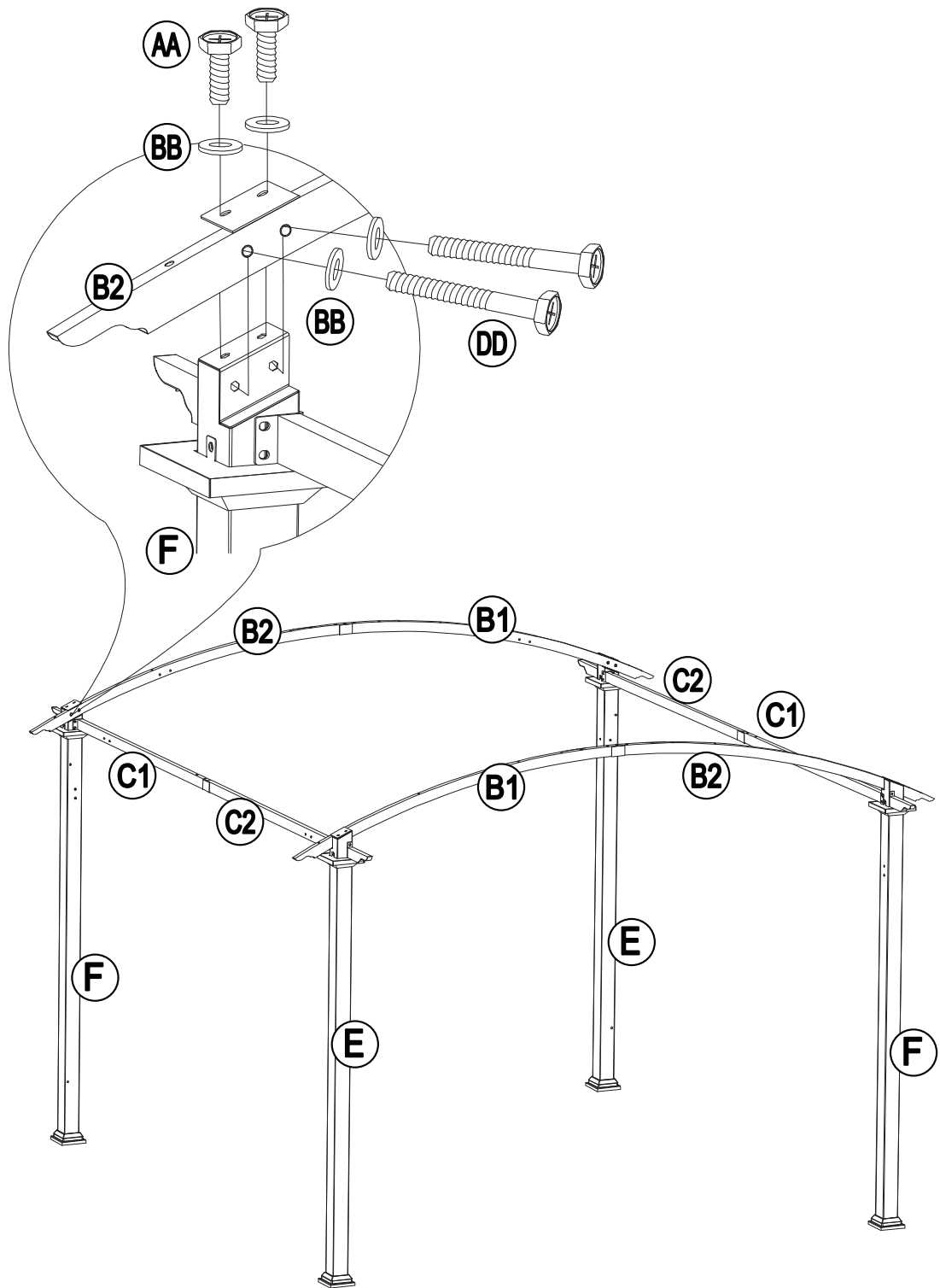

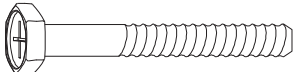
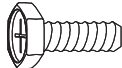
	<p>B1 x 2pcs</p>	
	<p>B2 x 2pcs</p>	 <p>BB x 8pcs</p>
	<p>B3 x 2pcs</p>	 <p>AA x 8pcs</p>

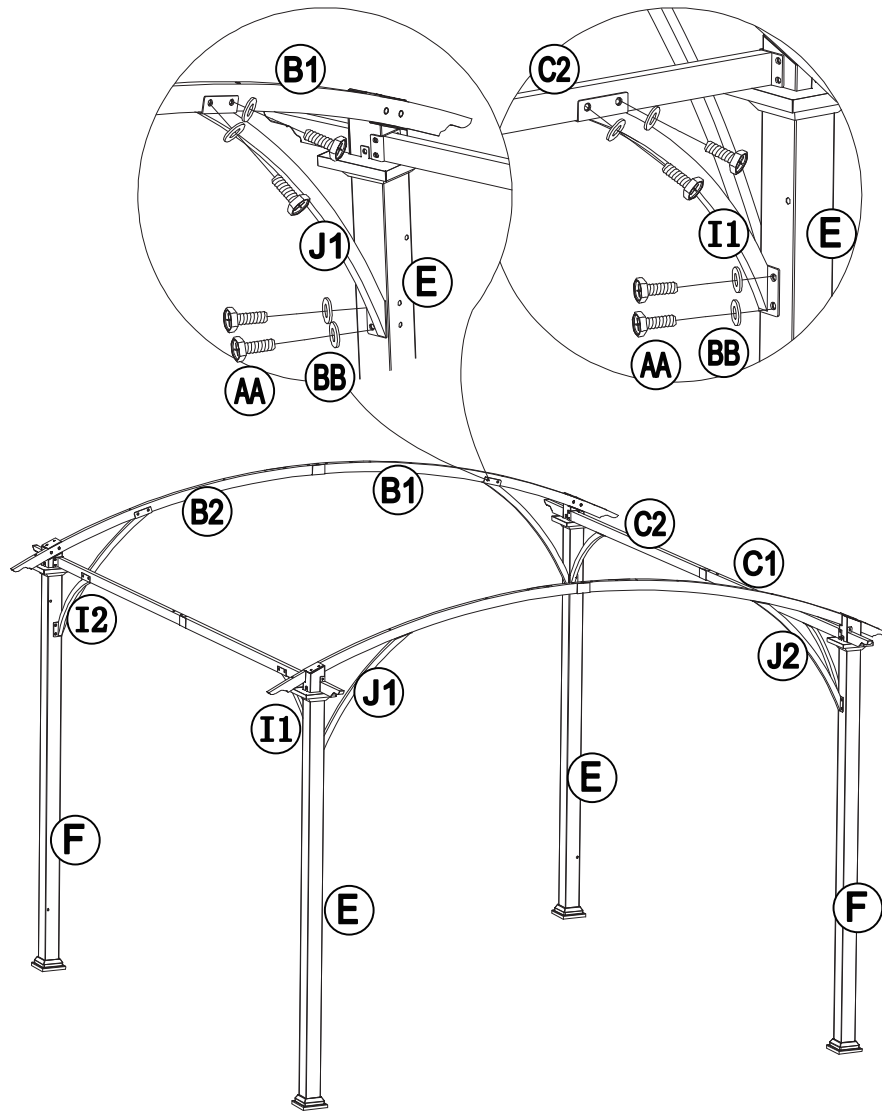



	 BB x 16pcs
 DD x 8pcs	 AA x 8pcs

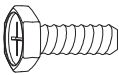

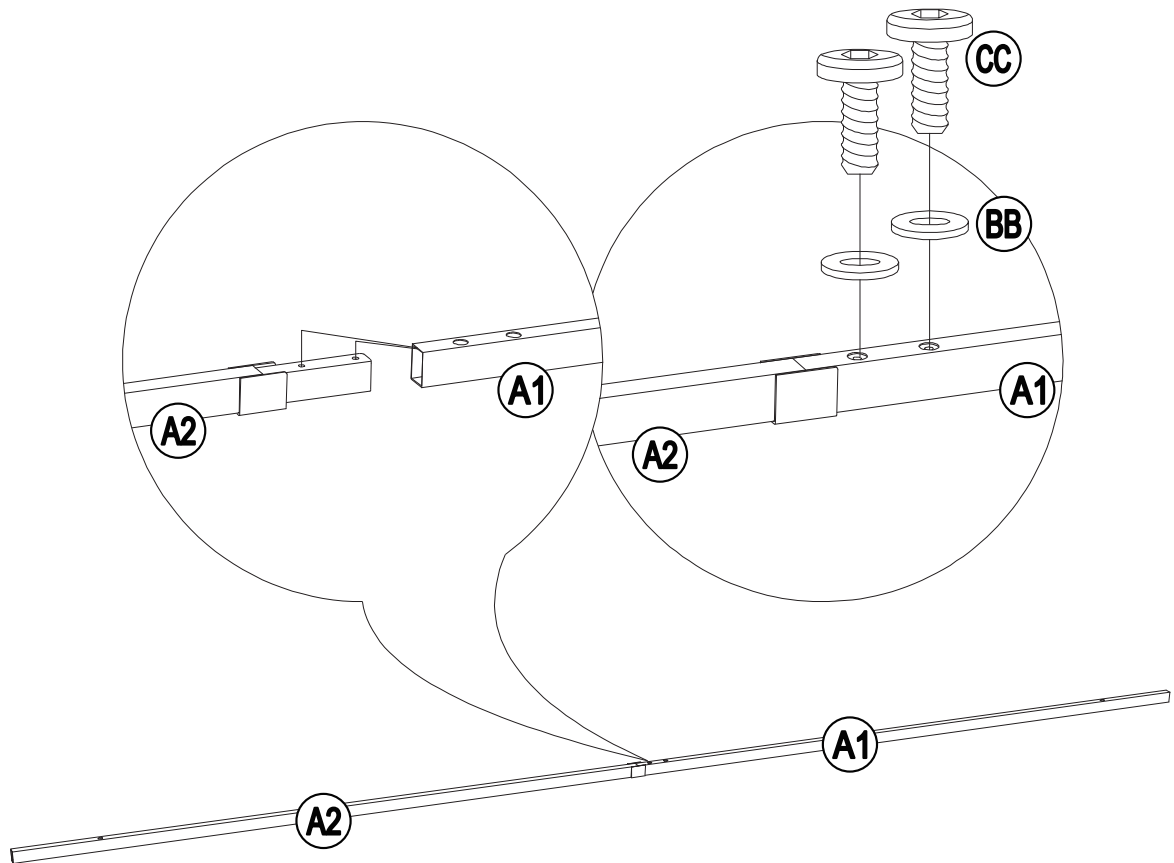

	J1 x 2pcs		I1 x 2pcs
	J2 x 2pcs		BB x 32pcs
	I2 x 2pcs		AA x 32pcs

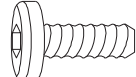

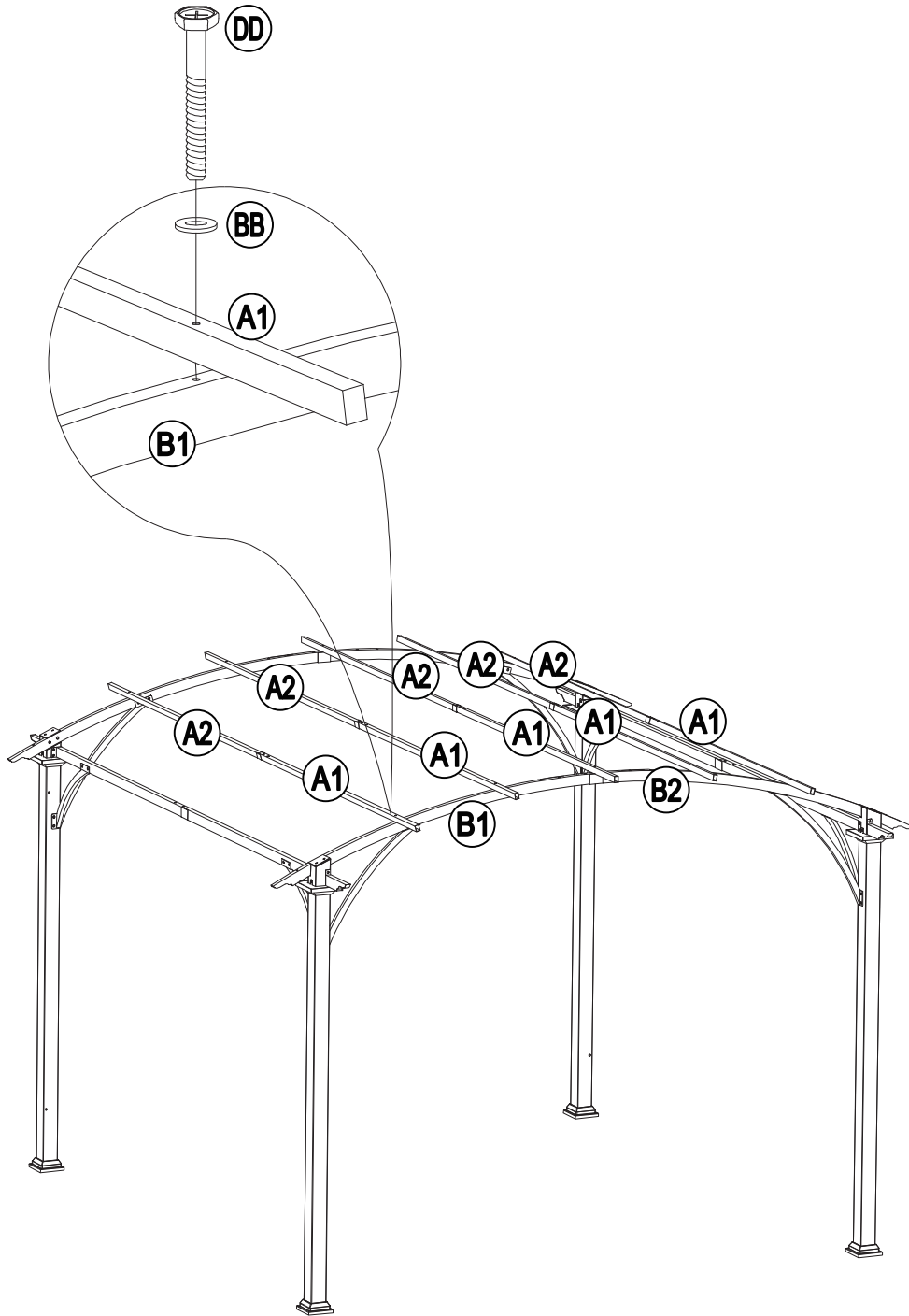

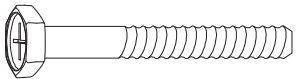

	A2 x 7pcs		BB x 14pcs
	A1 x 7pcs		CC x 14pcs

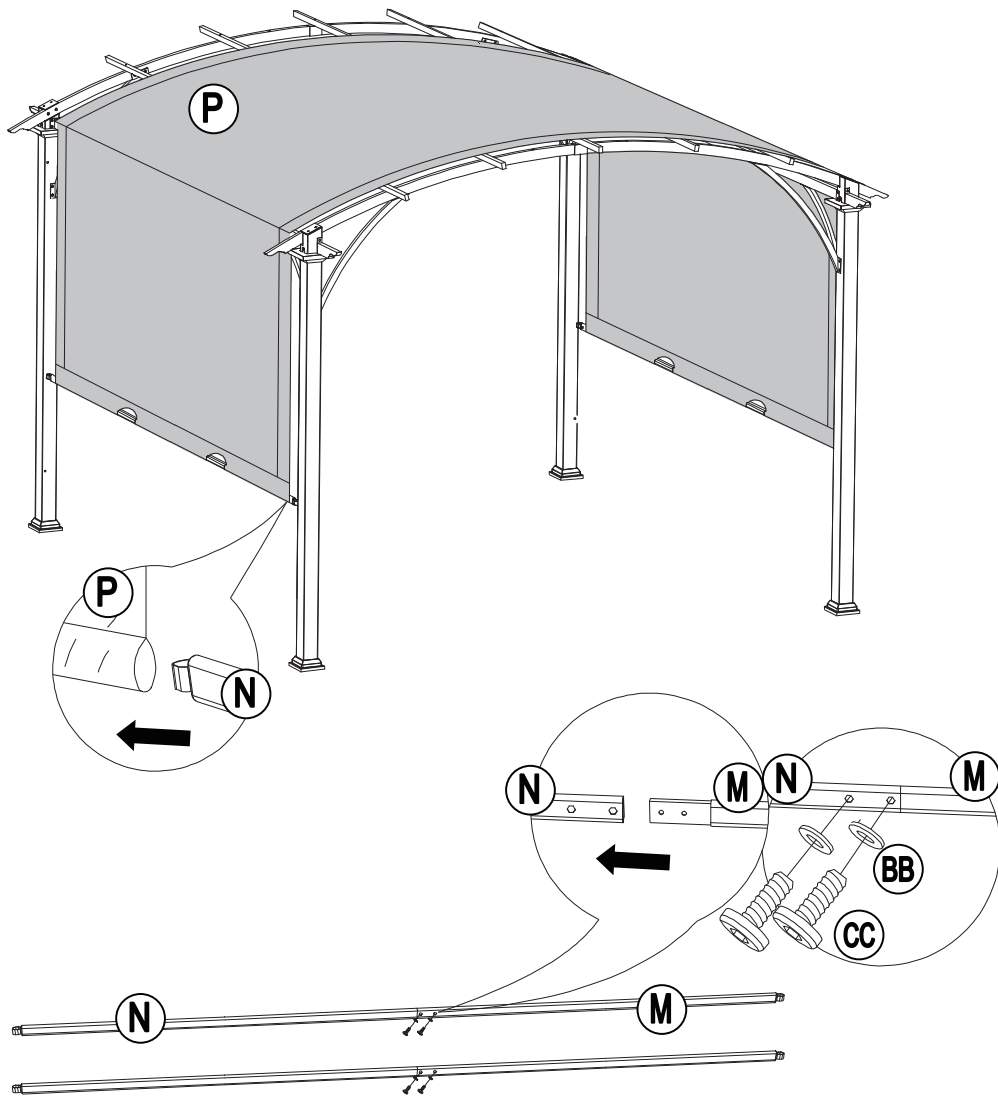



	<p>A1、 A2 x 5pcs</p>
	<p>DD x 10pcs</p>
	<p>BB x 10pcs</p>

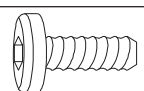

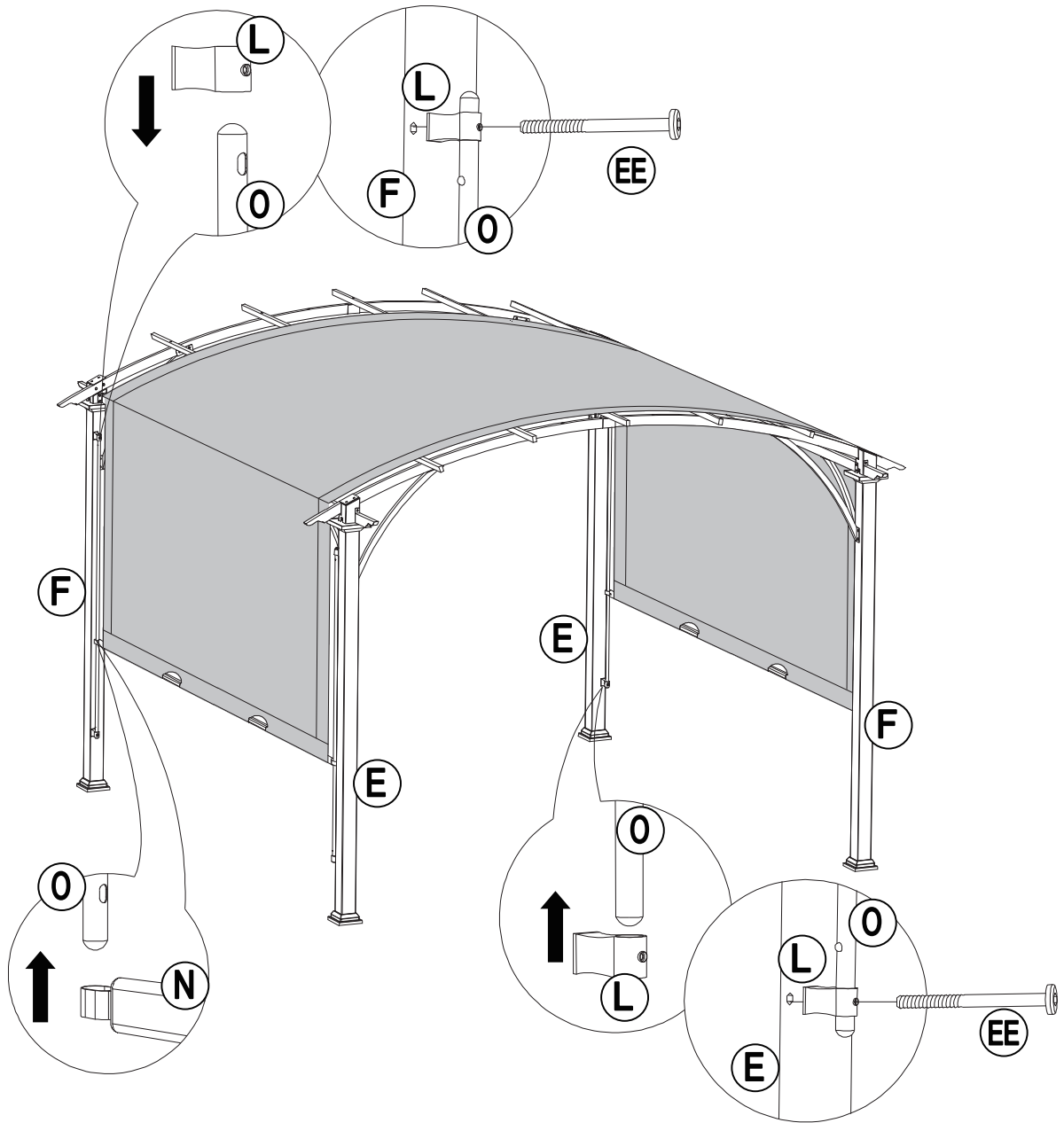

	M x 2pcs		
	N x 2pcs		BB x 4pcs
	P x 1pc		CC x 4pcs

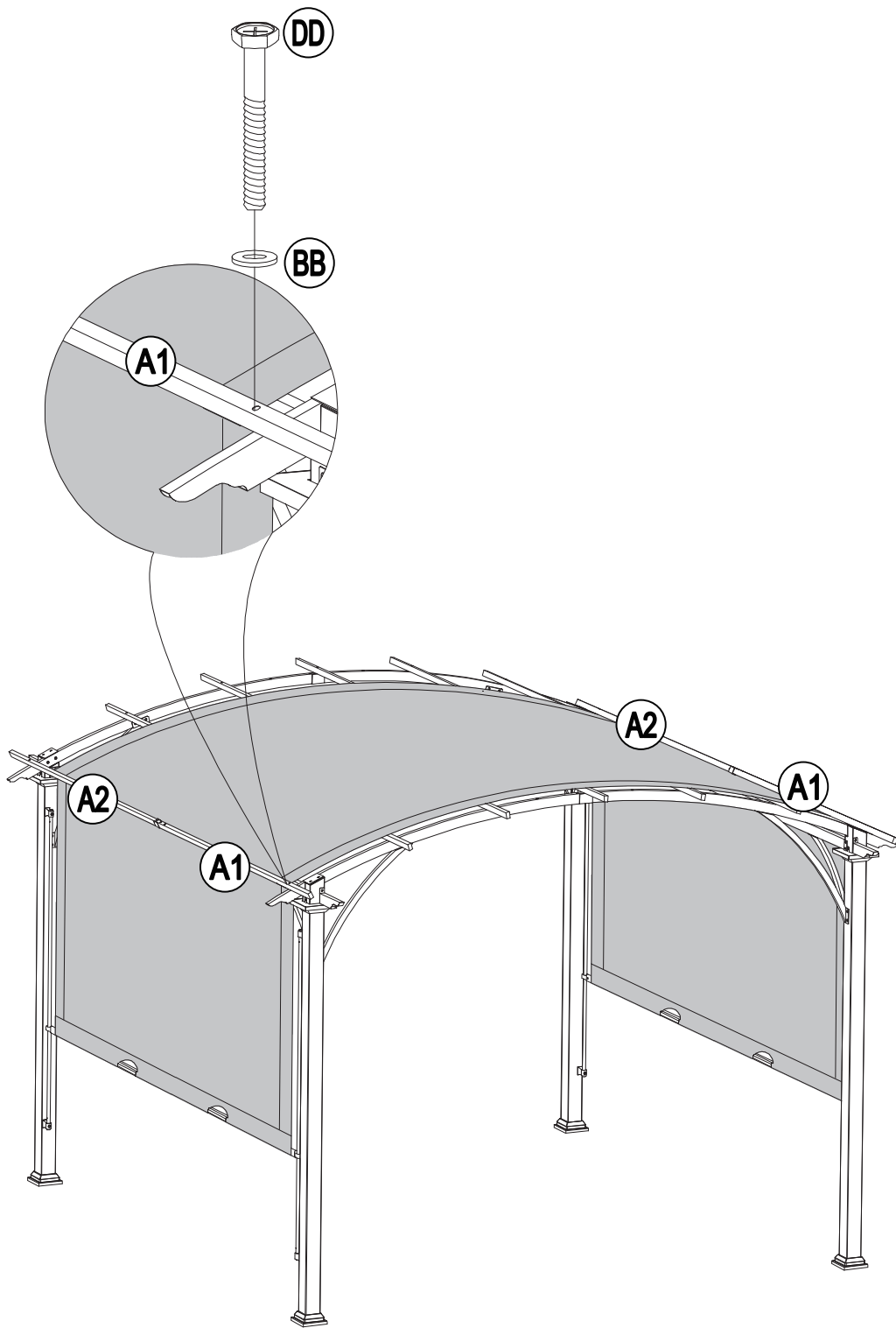

	O x 4pcs
 L x 8pcs	 EE x8pcs

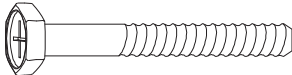

	A1, A2 x 2pcs
	DD x 4pcs
	BB x 4pcs

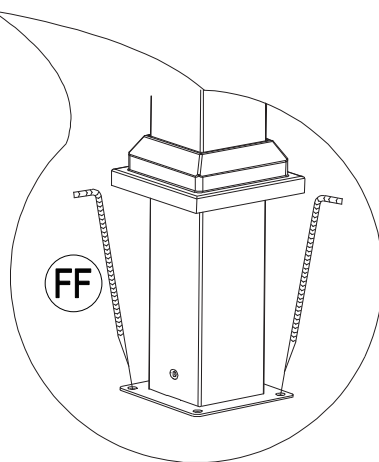
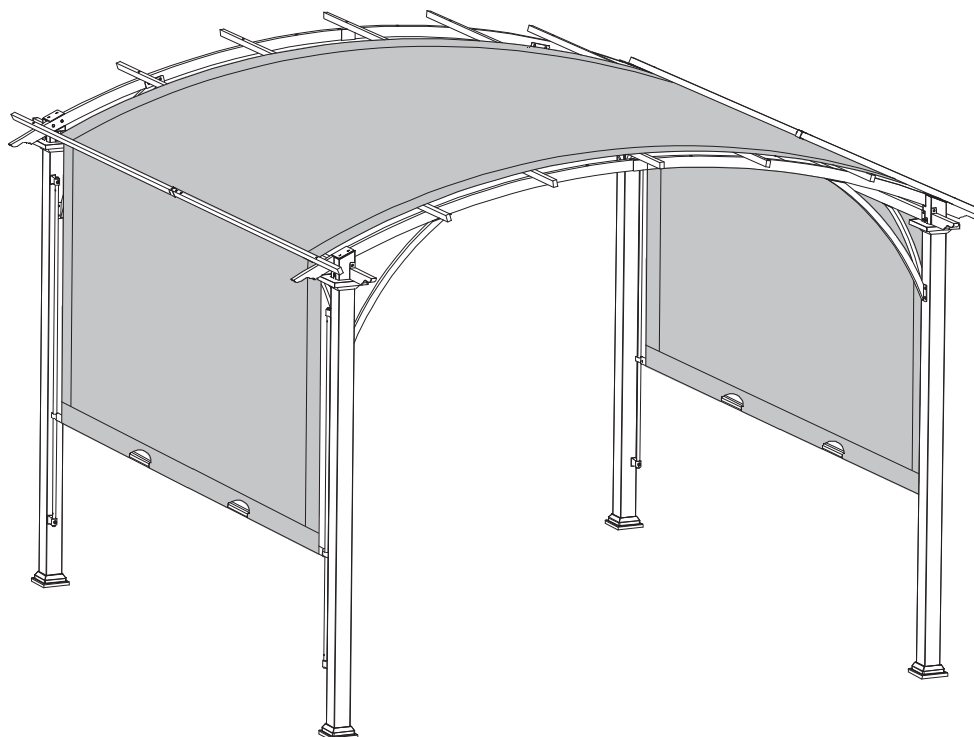

FF x 8pcs

US



001-877-644-9366
customerservice@aosom.com

CA



001-855-537-6088
customerservice@aosom.ca

UK



0044-800-240-4004
enquiries@mhstar.co.uk

DE



0049-(0)40-88307530
service@aosom.de

FR



0033-1-84166106
contact@aosom.fr

ES



0034-931294512
atencioncliente@aosom.es

IT



0039-0249471447
clienti@aosom.it