

Outsunny

MODEL# 84B-117

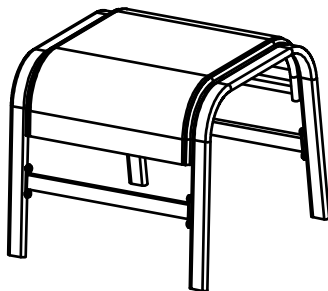
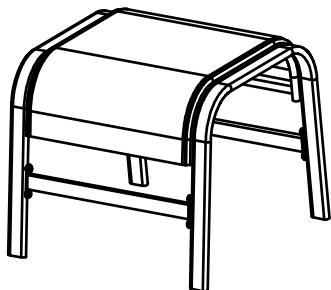
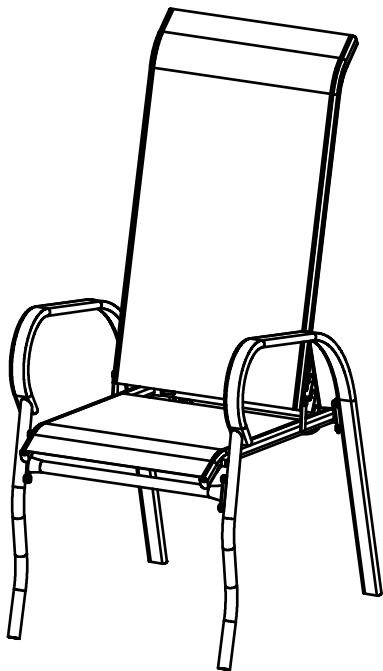
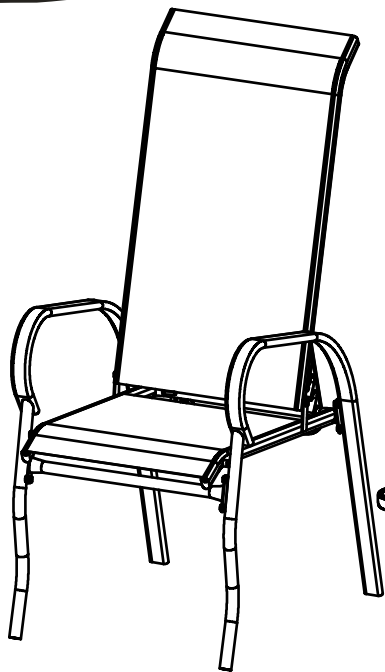

ASSEMBLY INSTRUCTIONS

Pre-Assembly and parts list

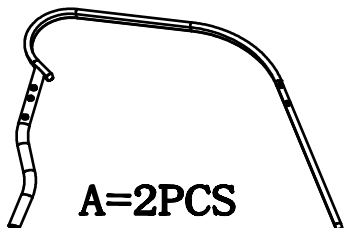

A=2PCS

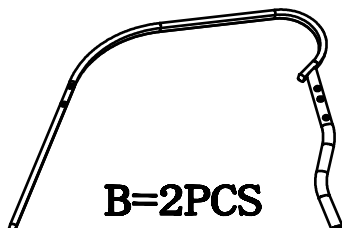

B=2PCS

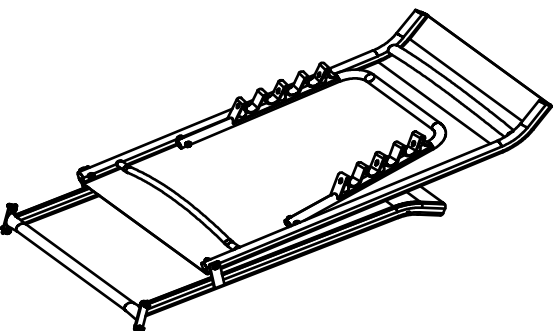

C=2PCS

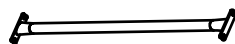

D=2PCS

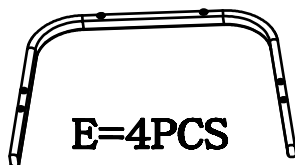

E=4PCS



F=4PCS

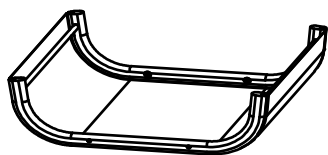

G=2PCS

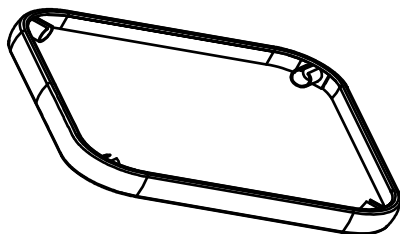

H=1PCS

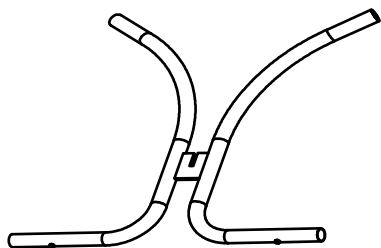

I=1PCS

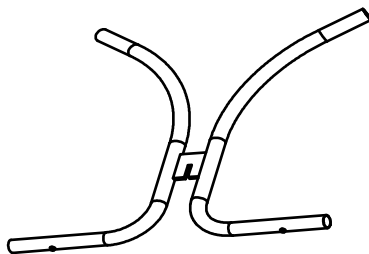







J=1PCS

Pre-Assembly and parts list

HARDWARE INCLUDED



NOTED: Hardware not shown to actual size.

Part	Description	Size	QTY.
K		(M6x45)	4
L		(M6x30)	8
M		(M6x15)	32
N			44
O			4
P			1

Assembly

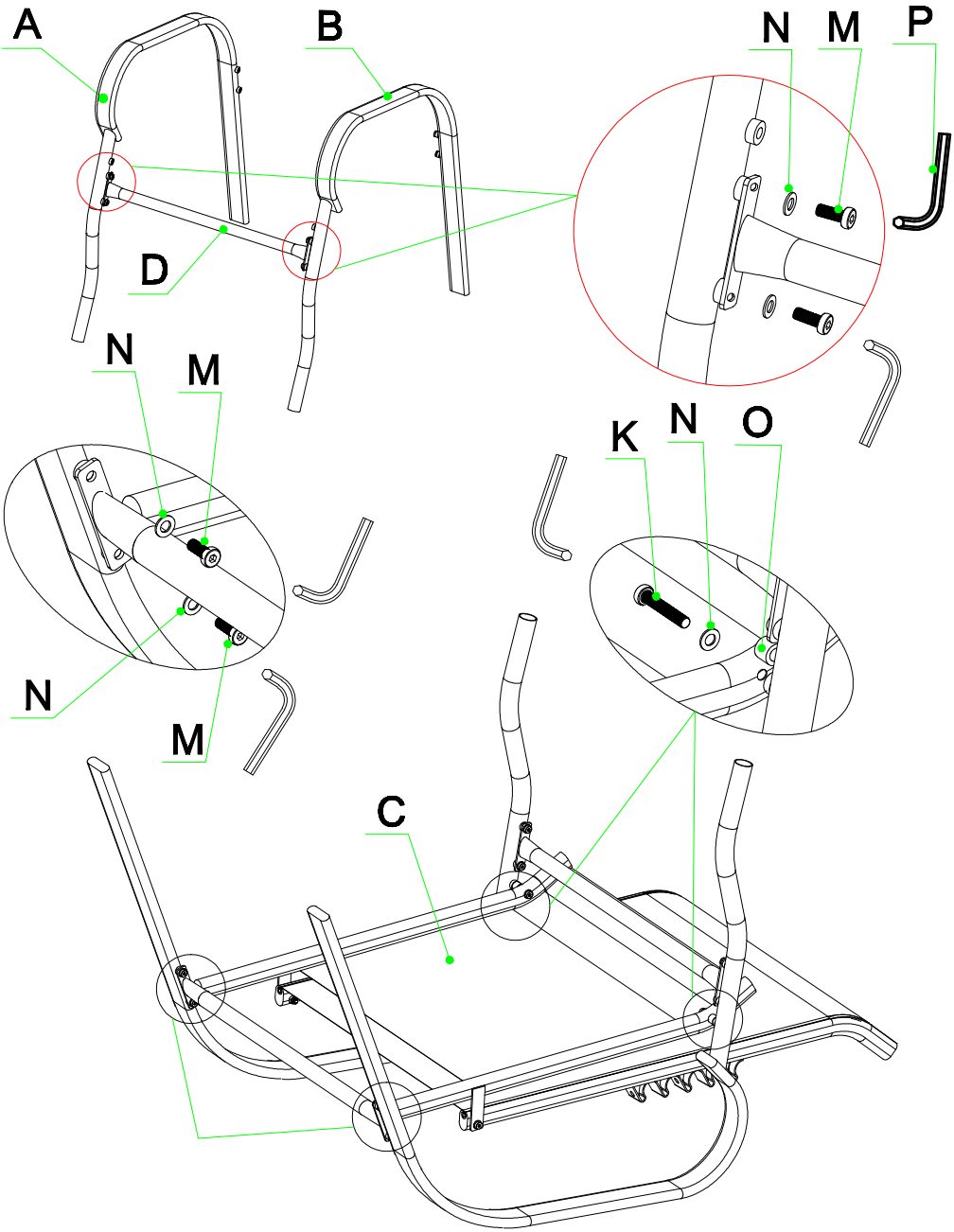

Assembly

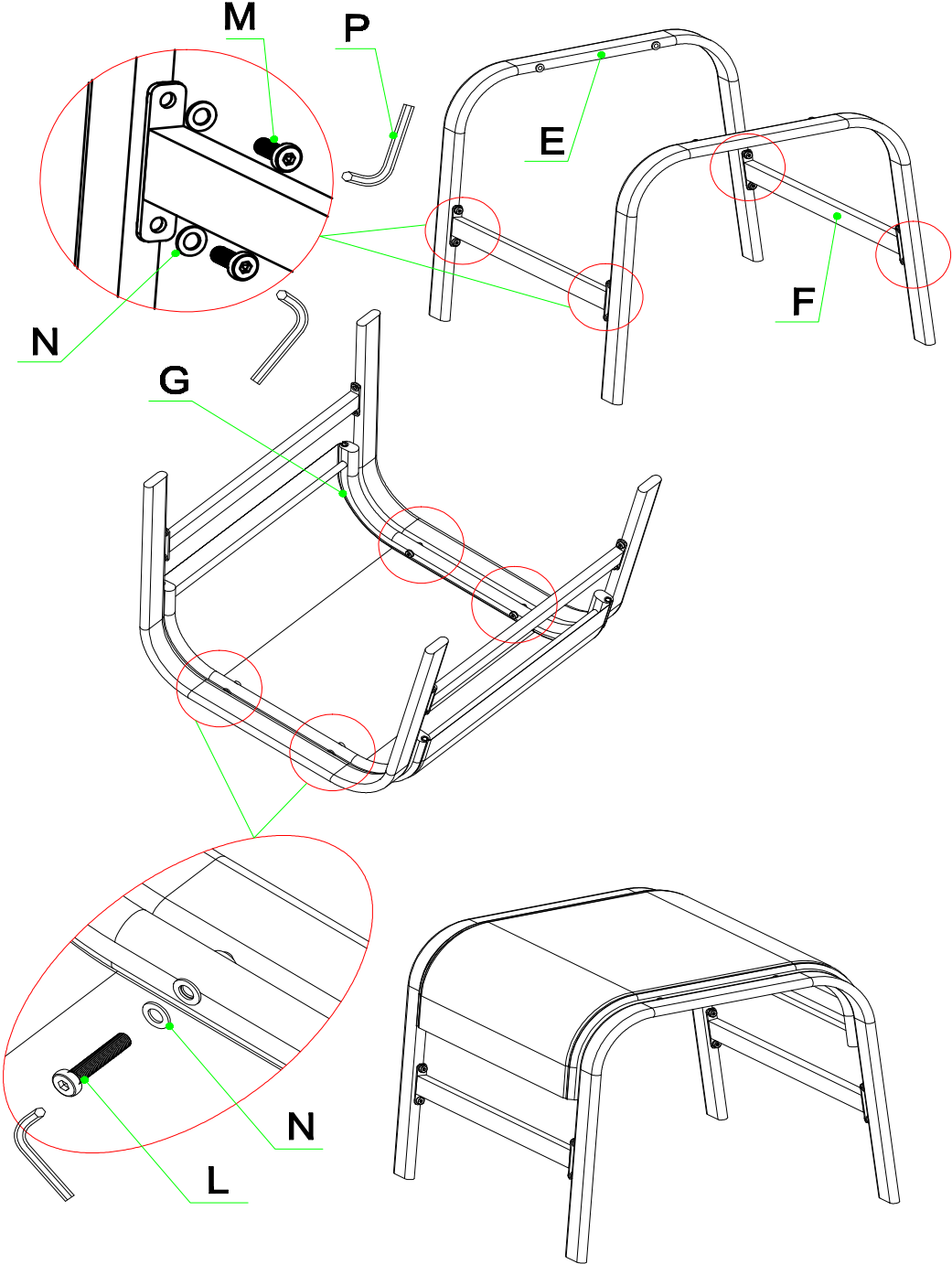

Assembly

