

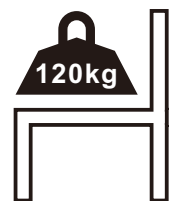

INbbc031V01\_US\_CA

**84A-066**

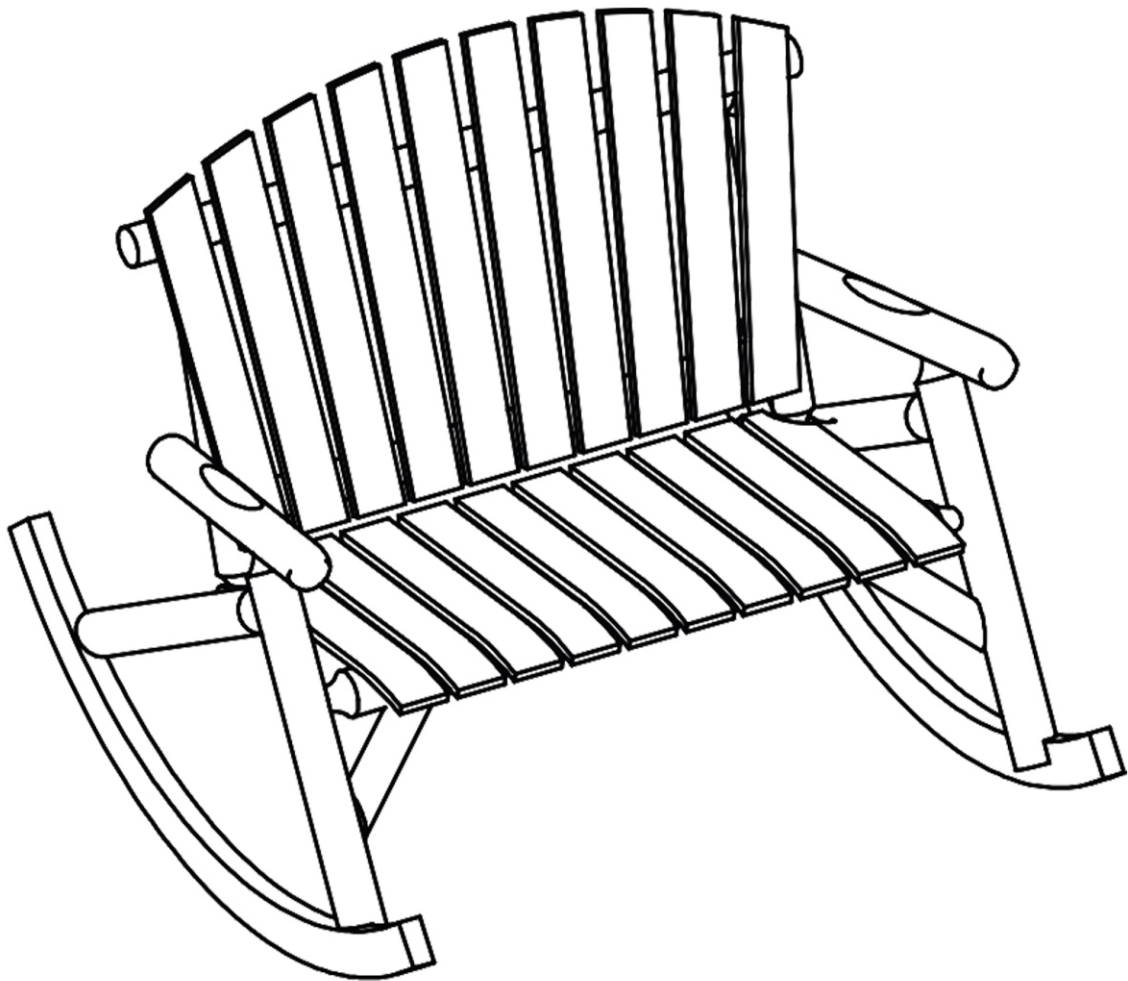

**IMPORTANT, RETAIN FOR FUTURE REFERENCE: READ CAREFULLY**

# ASSEMBLY & INSTRUCTION MANUAL

# Garden Chairs

**IMPORTANT, RETAIN FOR FUTURE REFERENCE: READ CAREFULLY**

**Only for domestic use**

**Use tips:**

- \*Put the chair stably on a flat floor.
- \*Mount the garden chairs in the shelter of the weather.
- \*Stay away from open flames.
- \*Don't hang anything in the structure.
- \*Avoid the overload at the anchors/structure.
- \*It is advised that don't stay on the chairs when there is a storm.
- \*It is recommended to protect in case of strong wind or rain and in your absence.

**Precautions before assembly:**

- \*Prepare a clean and dry mounting area.
- \*Verify that the product is not damaged.
- \*Check that none of the pieces are missing.

**Maintenance:**

- \*Clean with a soft fabric.
- \*Regularly remove leaves and / or water collected on the canvas.
- \*Check the chair regularly.

**Storage conditions:**

\*The fabric should be stored completely dry, in a clean and dry place to avoid the risks of mold.

**Caution with the risks of pinching or cuts during assembly.**

**The manufacturer declines all responsibility in case of damages due to a bad installation or due to weather.**

# Chaises de jardin

## **IMPORTANT - CONSERVEZ CES INFORMATIONS POUR VOTRE CONSULTATION ULTÉRIEURE: LISEZ ATTENTIVEMENT**

**Seulement pour usage domestique**

### **Conseils:**

- \* Placez la chaise de manière stable sur un sol plat.
- \* Installez les chaises de jardin à l'abri des intempéries.
- \* Restez à l'écart des flammes ouvertes.
- \* Ne rien accrocher dans la structure.
- \* Évitez de surcharger les extrémités de la structure
- \* Il est conseillé de ne pas rester sur la chaise en cas d'orage.
- \* Il est recommandé de la protéger en cas de vent fort ou de pluie et en votre absence.

### **Précautions avant l'assemblage:**

- \* Préparez une zone de montage propre et sèche.
- \* Vérifiez que le produit n'est pas endommagé.
- \* Vérifiez qu'aucun des morceaux ne manque.

### **Recommandations d'entretien:**

- \* Veuillez utiliser un chiffon doux pour essuyer la chaise.
- \* Veuillez nettoyer régulièrement l'eau stagnante du fauteuil
- \* Veuillez vérifier régulièrement la chaise pour éviter une structure lâche.

### **Conditions de stockage:**

- \* Veuillez stocker le produit dans un environnement propre et sec pour éviter tout risque de moisissure.

**Veillez faire attention à ne pas être pris ou rayé par le produit lors de l'assemblage**

**Le fabricant n'est pas responsable des dommages causés par une mauvaise installation.**

**Si le fauteuil est équipé d'un dispositif de hauteur réglable avec accumulateur, seul une personne qualifiée peut remplacer ou réparer la partie de hauteur réglable du siège.**

**PARTS**

**A** x 1

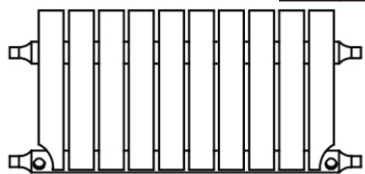

**B** x 1

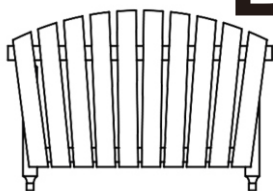

**C1** x 1

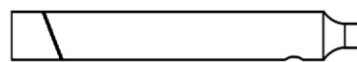

**C2** x 1

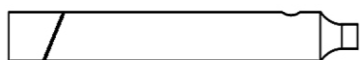

**D1** x 1

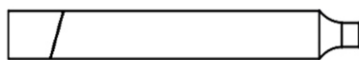

**D2** x 1



**E** x 2

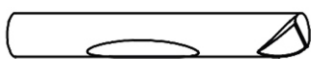

**F** x 2

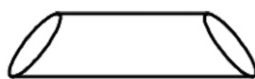

**G** x 2



**HARDWARE**

**1** x 14



**2** x 4



**3** x 2



C1x 1

C2x 1

D1x 1

D2x 1

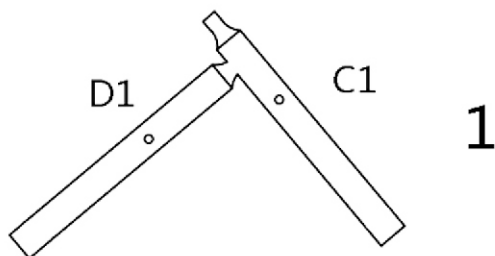

1

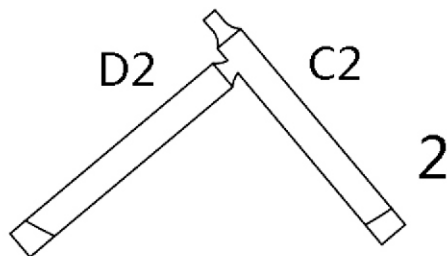

2

A x 1

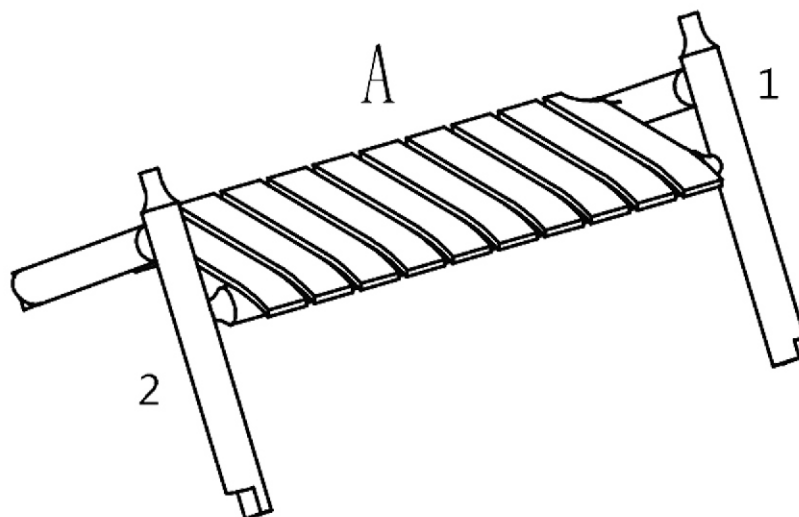

B x 1

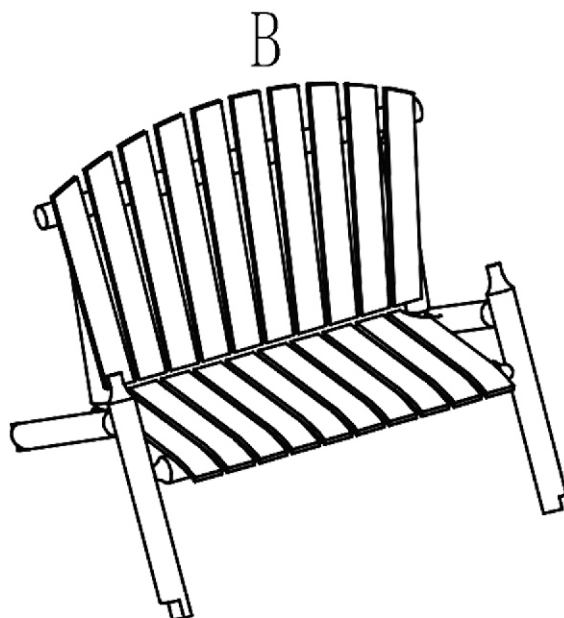

E x 2

③ x 2

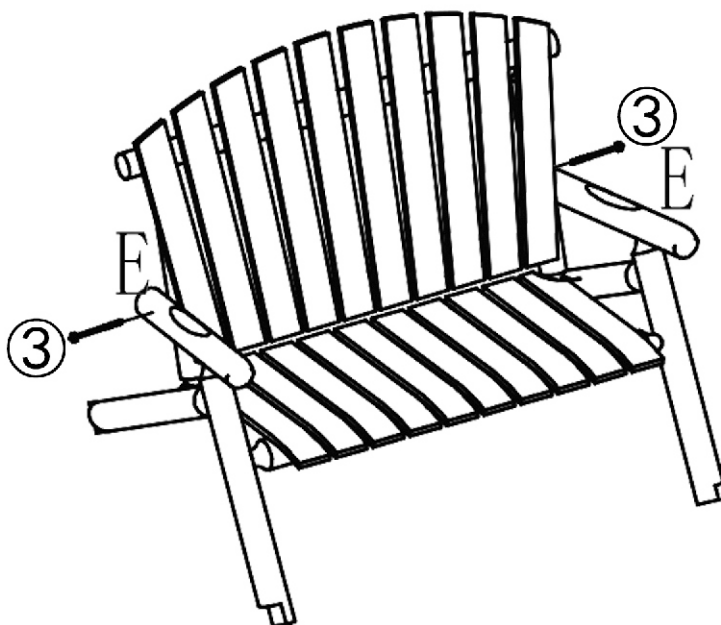

① x 6

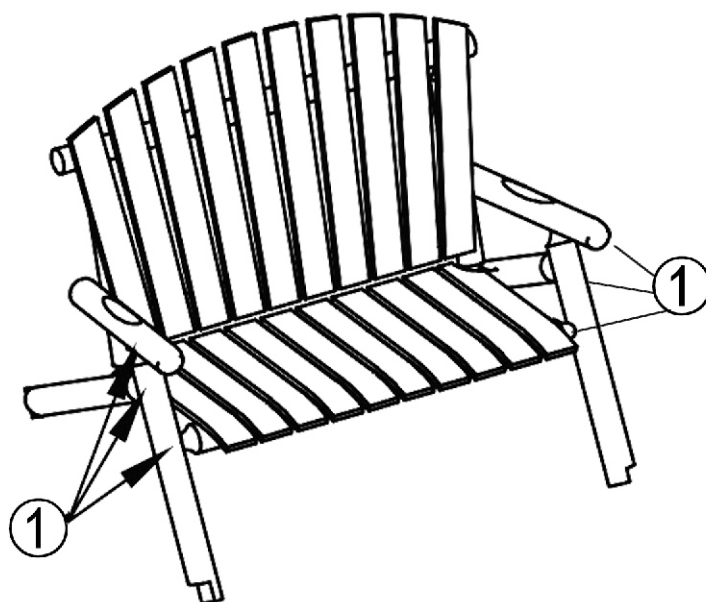

① x 4

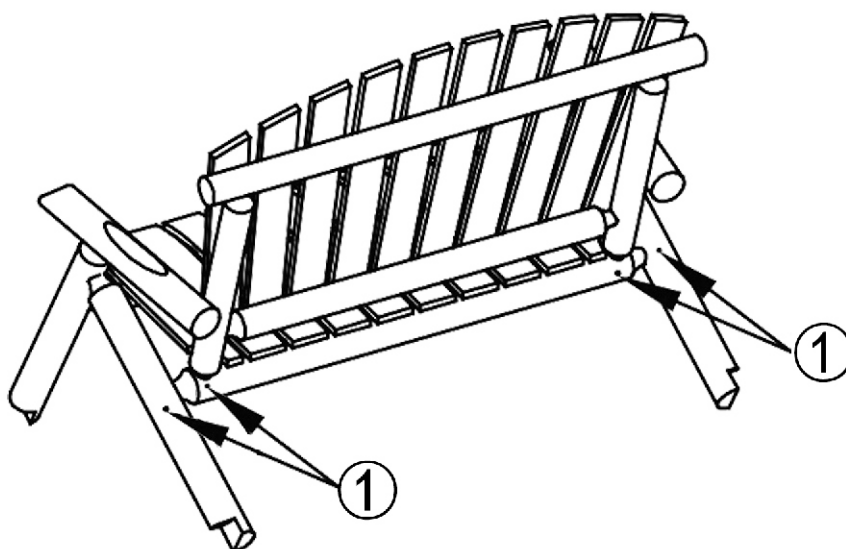

G x 2

① x 4

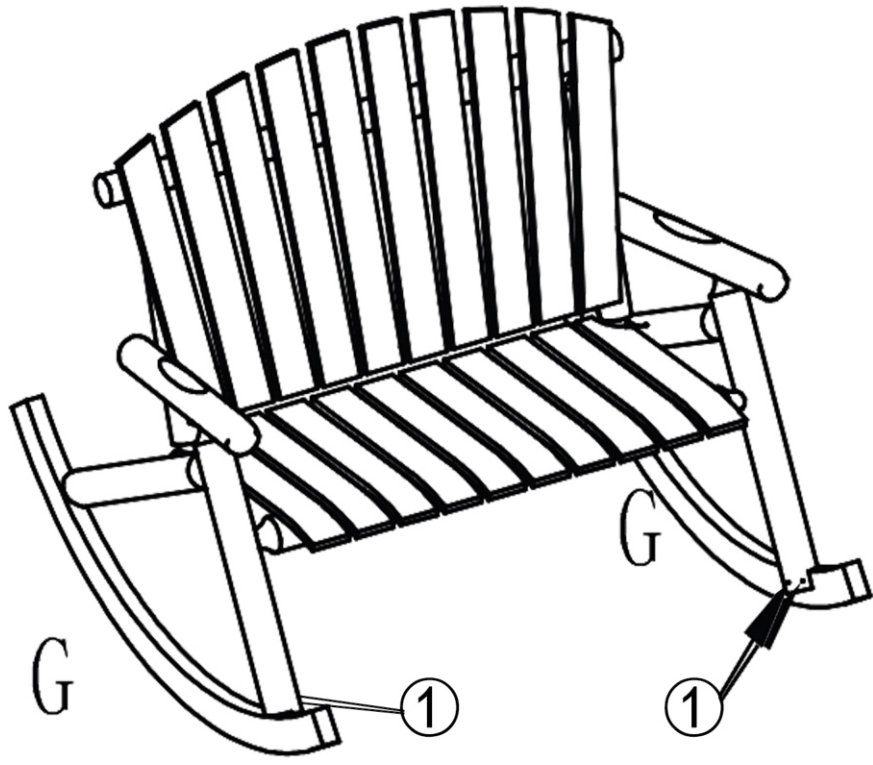

F x 2

② x 4

