

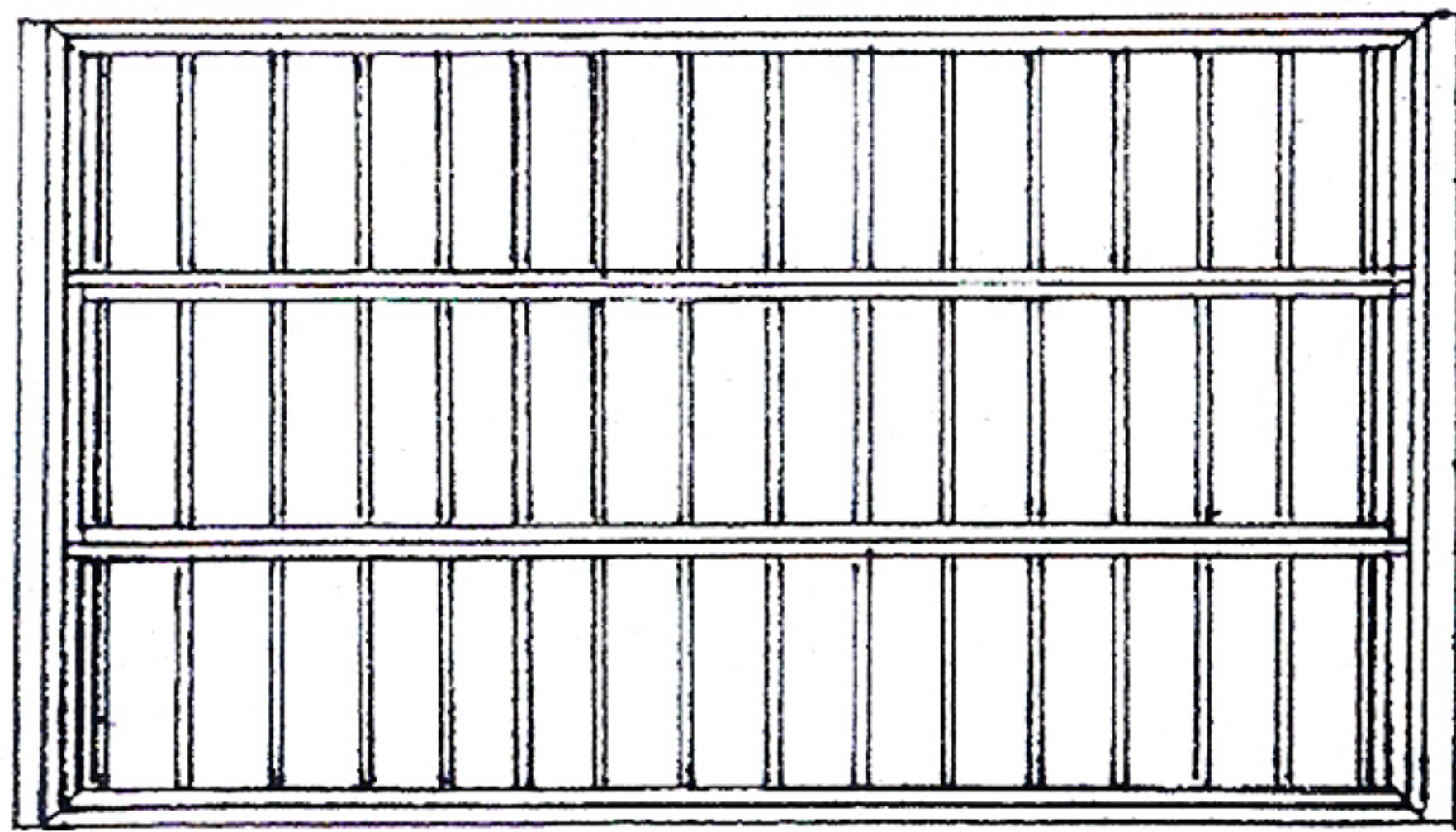

Assembly Instructions

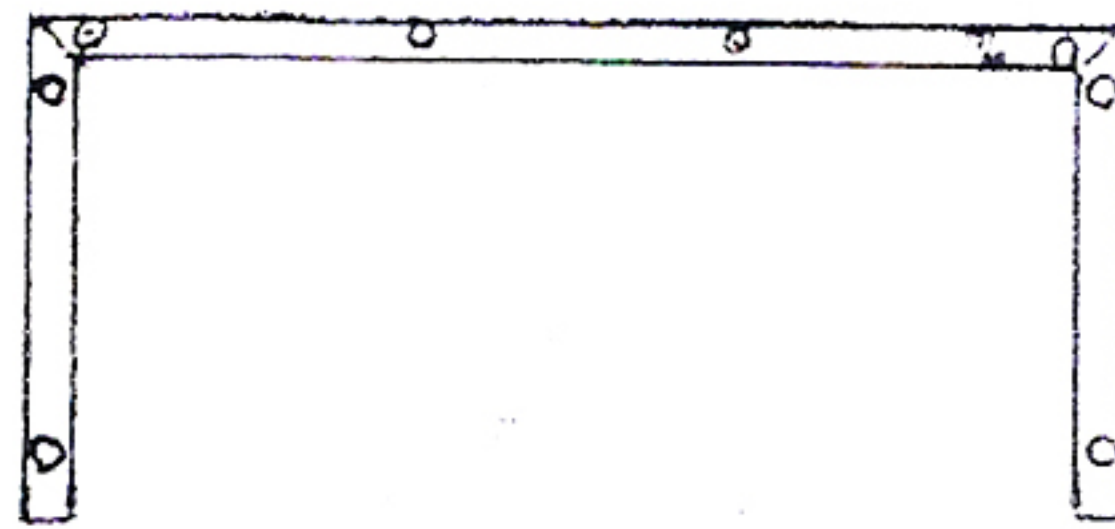

A 1PC



B 2PCS

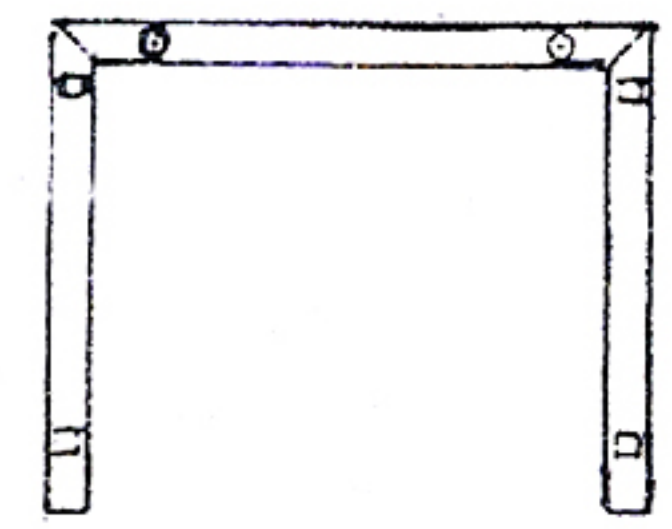

C 2PCS



M6*32MM

D 8PCS

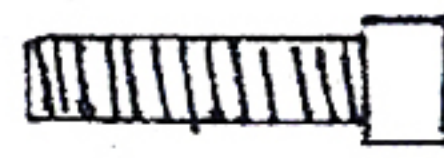

M6*25MM

E 12PCS

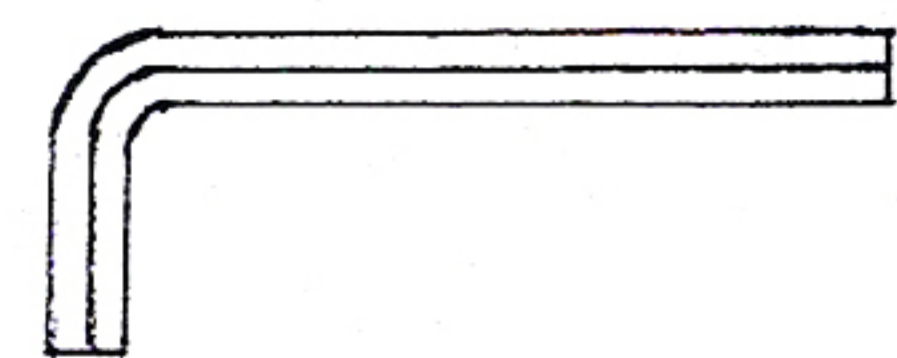

F 1PC

STEP1

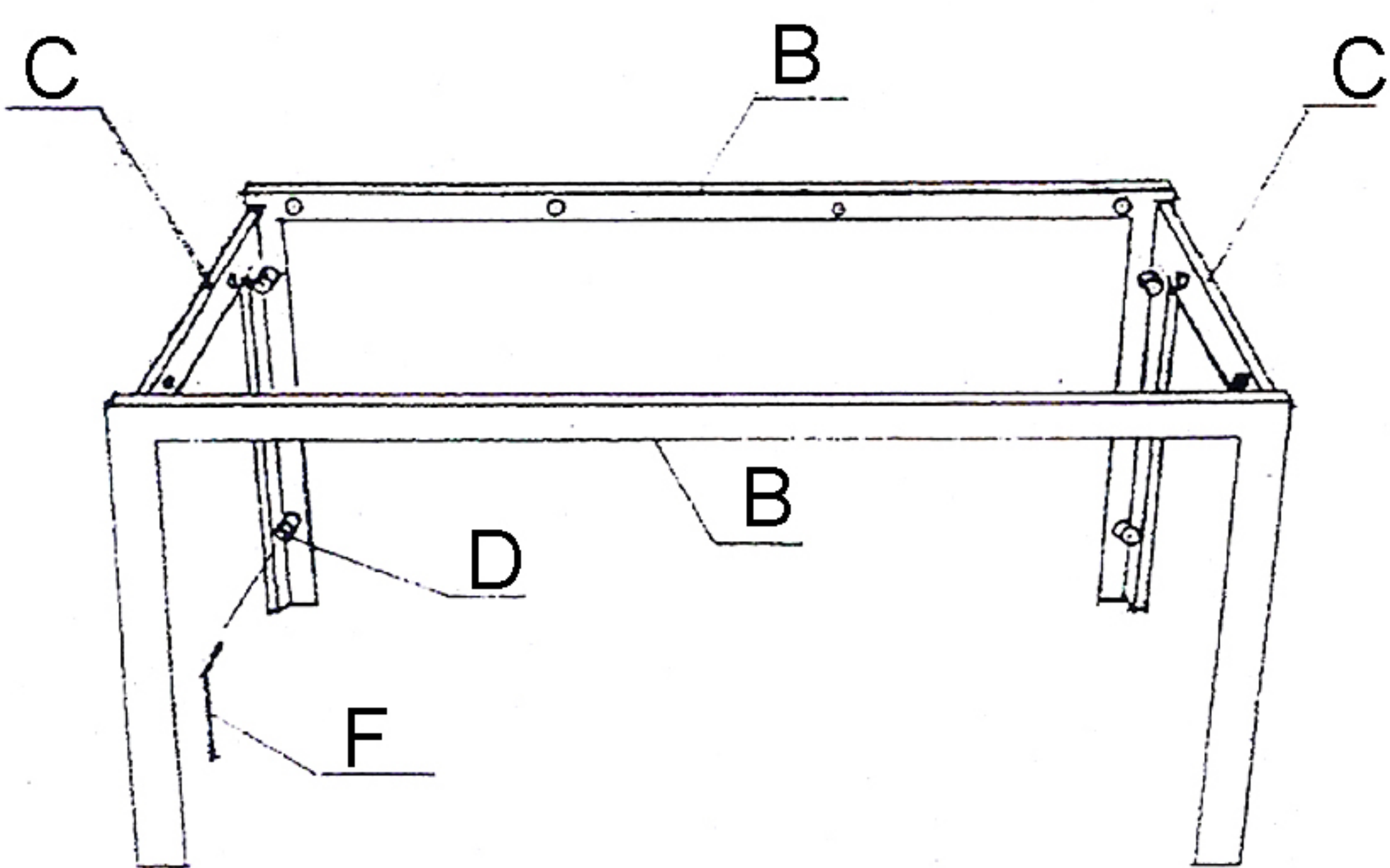

STEP2

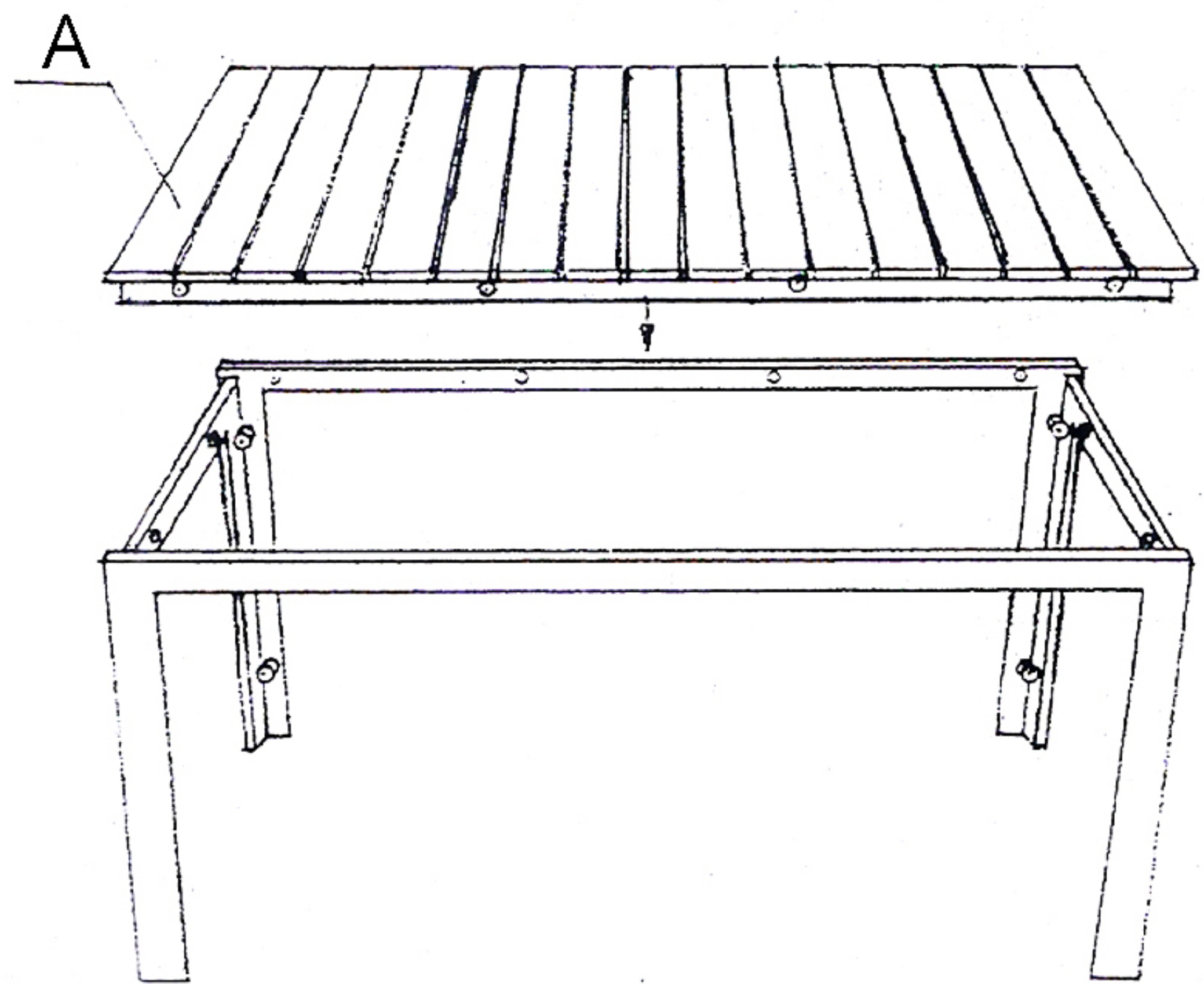

STEP3

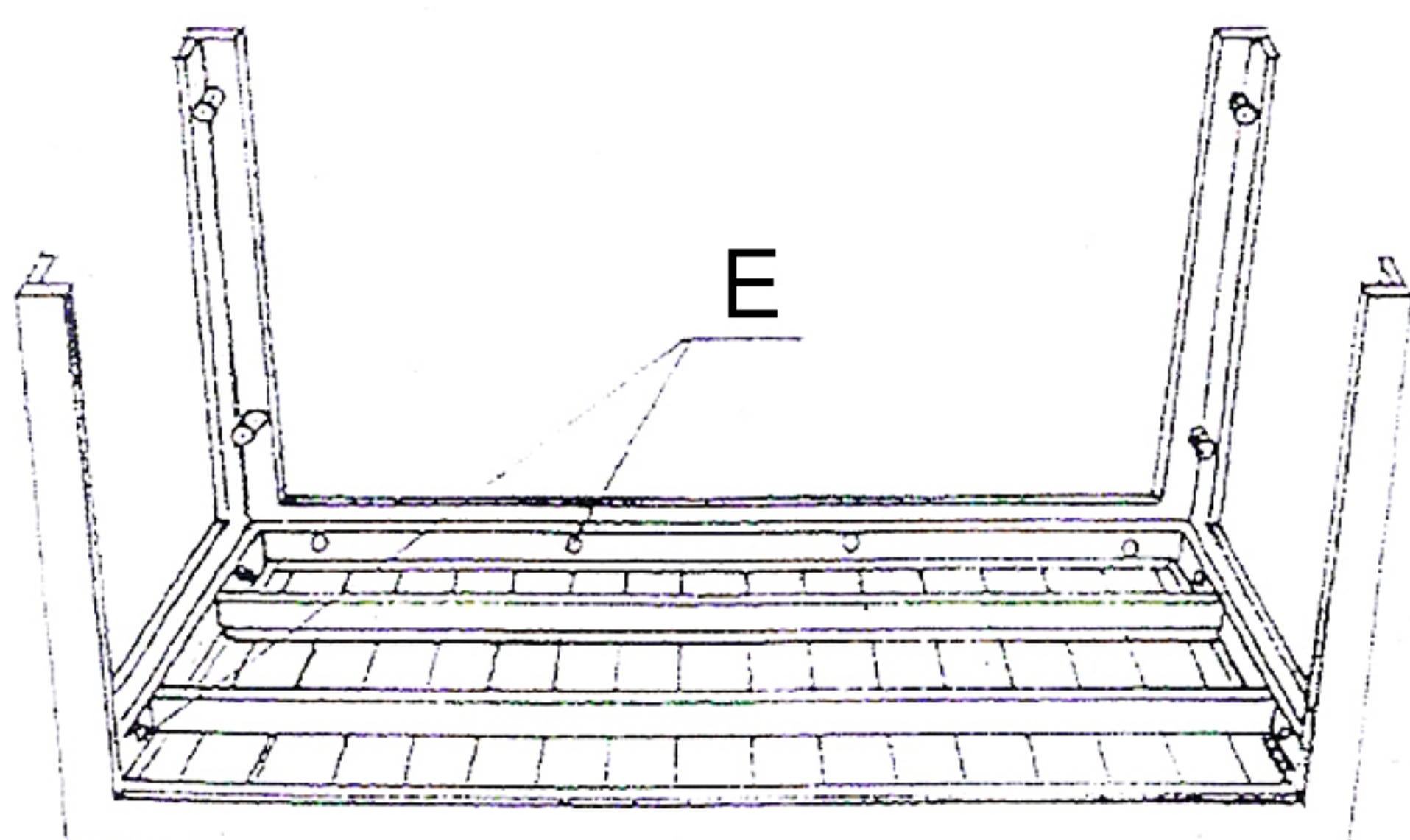

STEP4

