

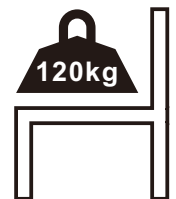

INbic004V01\_GL

**84A-167**

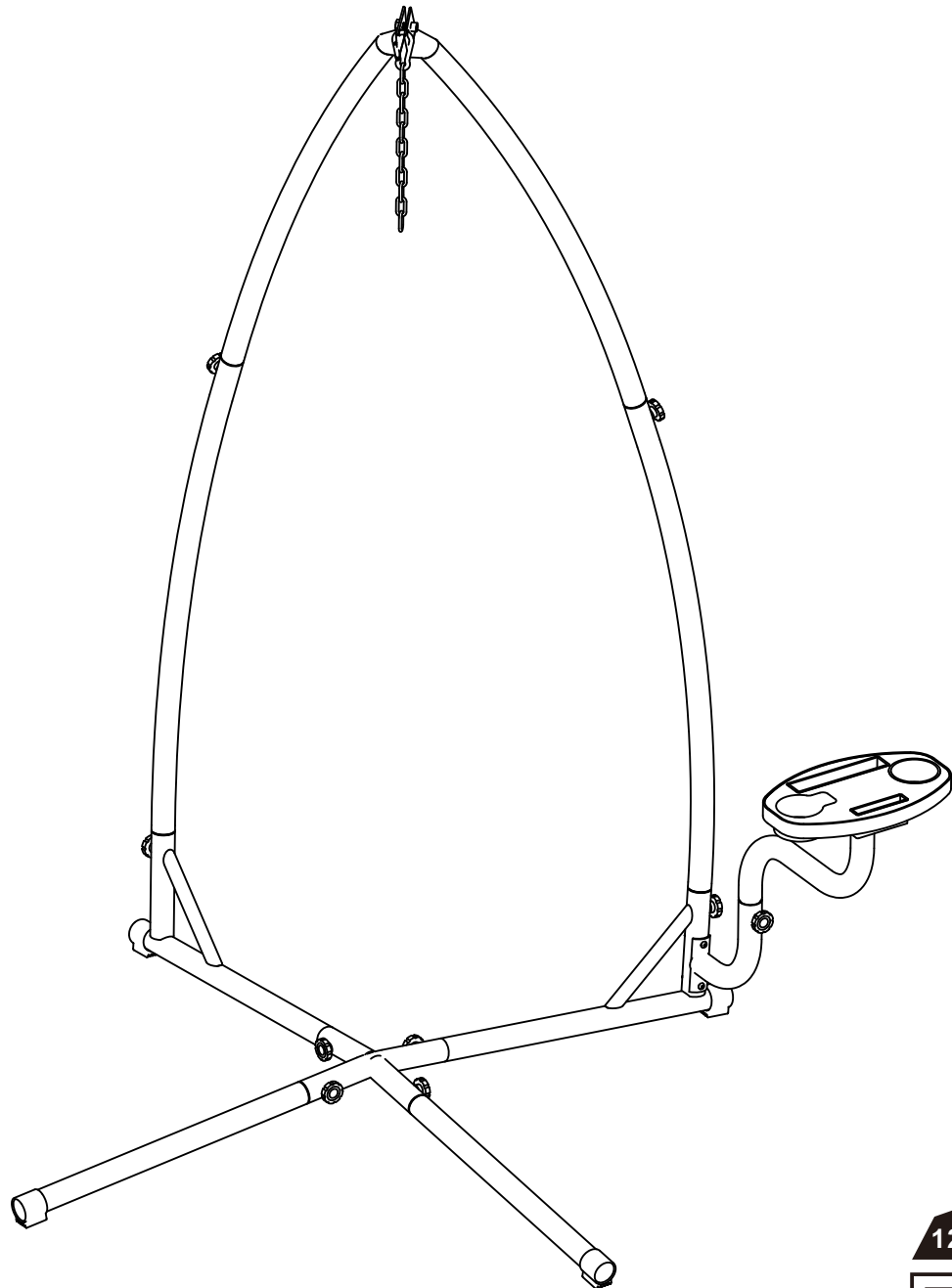

**IMPORTANT, RETAIN FOR FUTURE REFERENCE: READ CAREFULLY**

# ASSEMBLY & INSTRUCTION MANUAL

**PARTS**

**A** x 1



**B** x 1

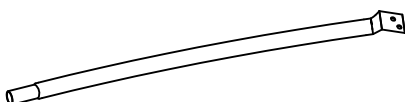

**C** x 2



**D** x 1

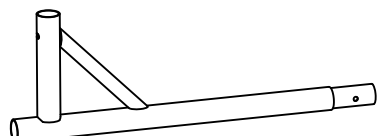

**E** x 1

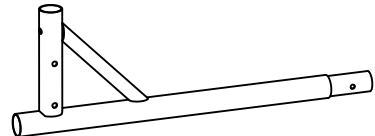

**F** x 2



**G** x 1



**H** x 1

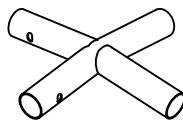

**I** x 1

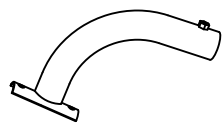

**J** x 1

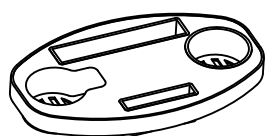

**K** x 4

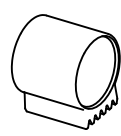

**HARDWARE**

**L** x 9

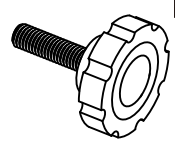

**M** x 1

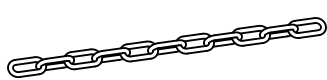

**N** x 1

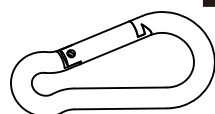

**O** x 1  
M10\*25



**P** x 2  
M8\*55



**Q** x 1



**R** x 1  
M5



