

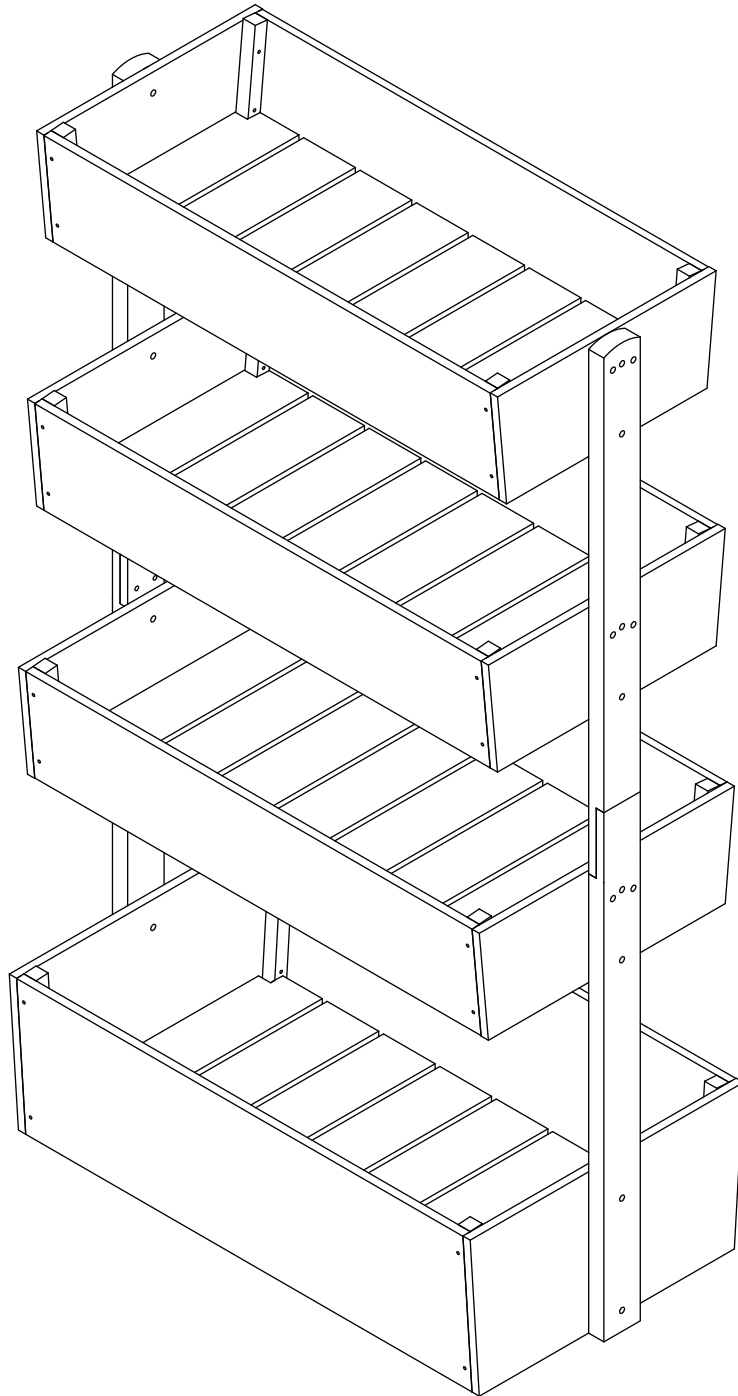

INbmb098_GL

845-585



IMPORTANT, RETAIN FOR FUTURE REFERENCE: READ CAREFULLY

ASSEMBLY & INSTRUCTION MANUAL

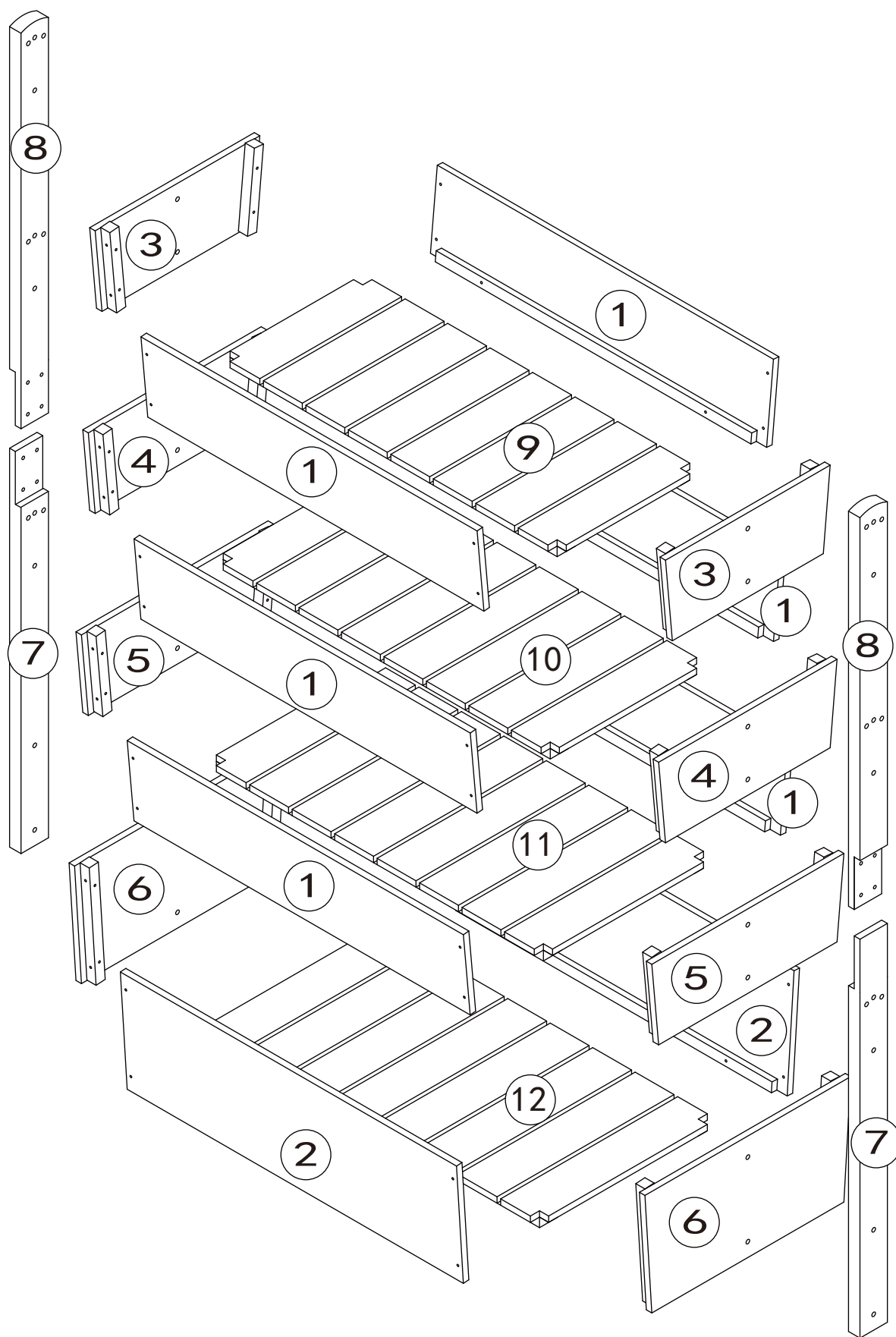

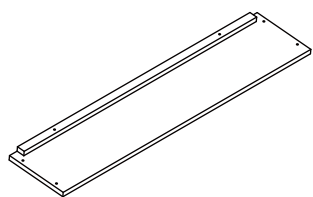

775 × 160 × 24 mm

① x 6

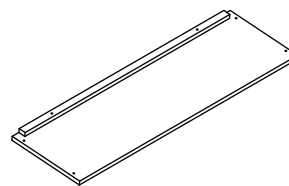

775 × 230 × 24 mm

② x 2

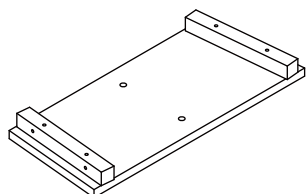

362 × 160 × 32 mm

③ x 2

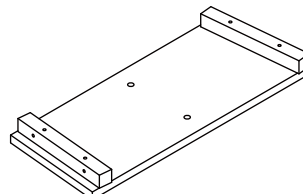

392 × 160 × 32 mm

④ x 2

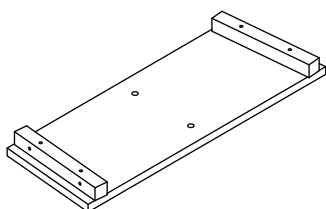

422 × 160 × 32 mm

⑤ x 2

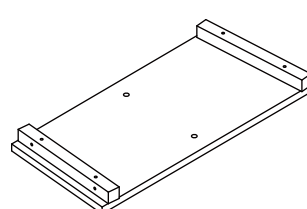

450 × 230 × 32 mm

⑥ x 2

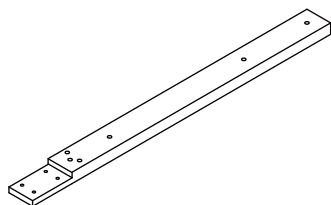

755 × 60 × 25 mm

⑦ x 2

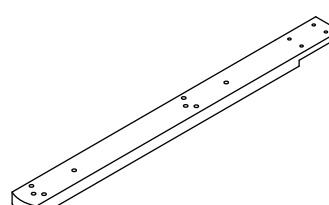

755 × 60 × 25 mm

⑧ x 2

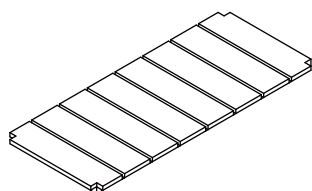

755 × 310 × 32 mm

⑨ x 1

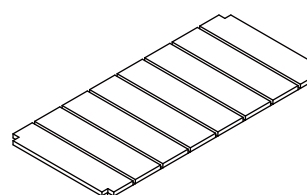

755 × 340 × 32 mm

⑩ x 1

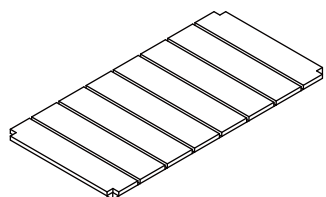

755 × 370 × 32 mm

⑪ x 1

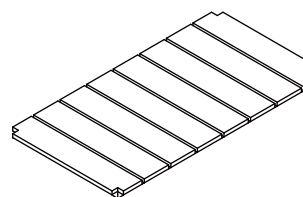

755 × 387 × 32 mm

⑫ x 1

A x32
M3.5*30
+1(spare)

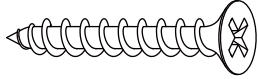

B x 8
M6*20
+1(spare)

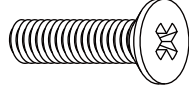

C x16
M6*45
+1(spare)



D x 1

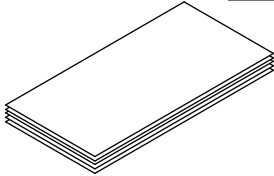

E x 1

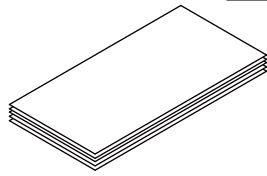

F x 1

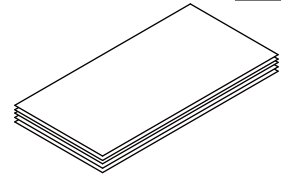

G x 1

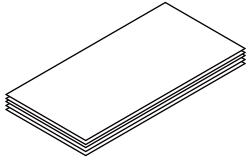

H x48
+2(spare)

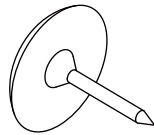

I x 1



M3.5 × 30

A × 16

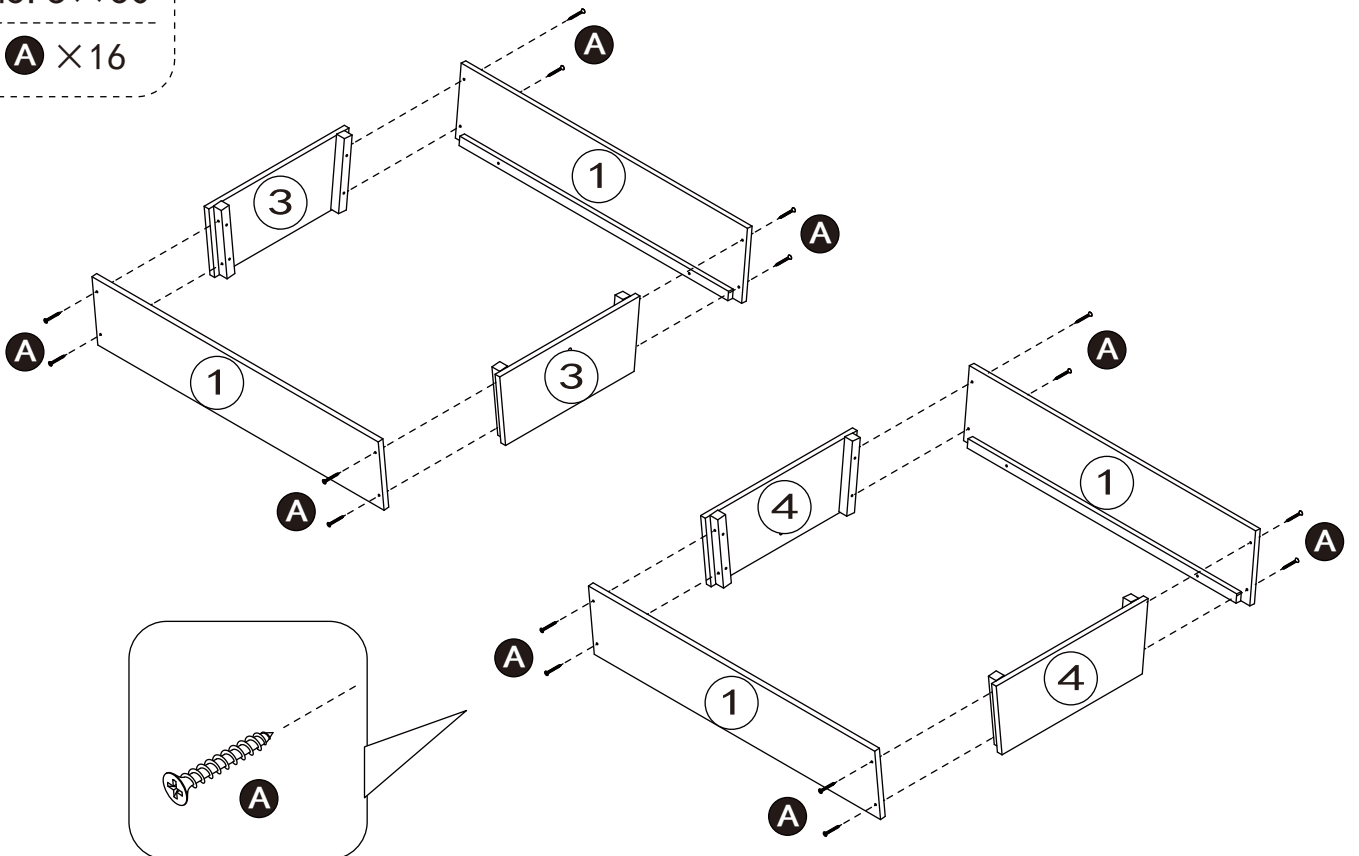



M3.5 x 30

A x 16

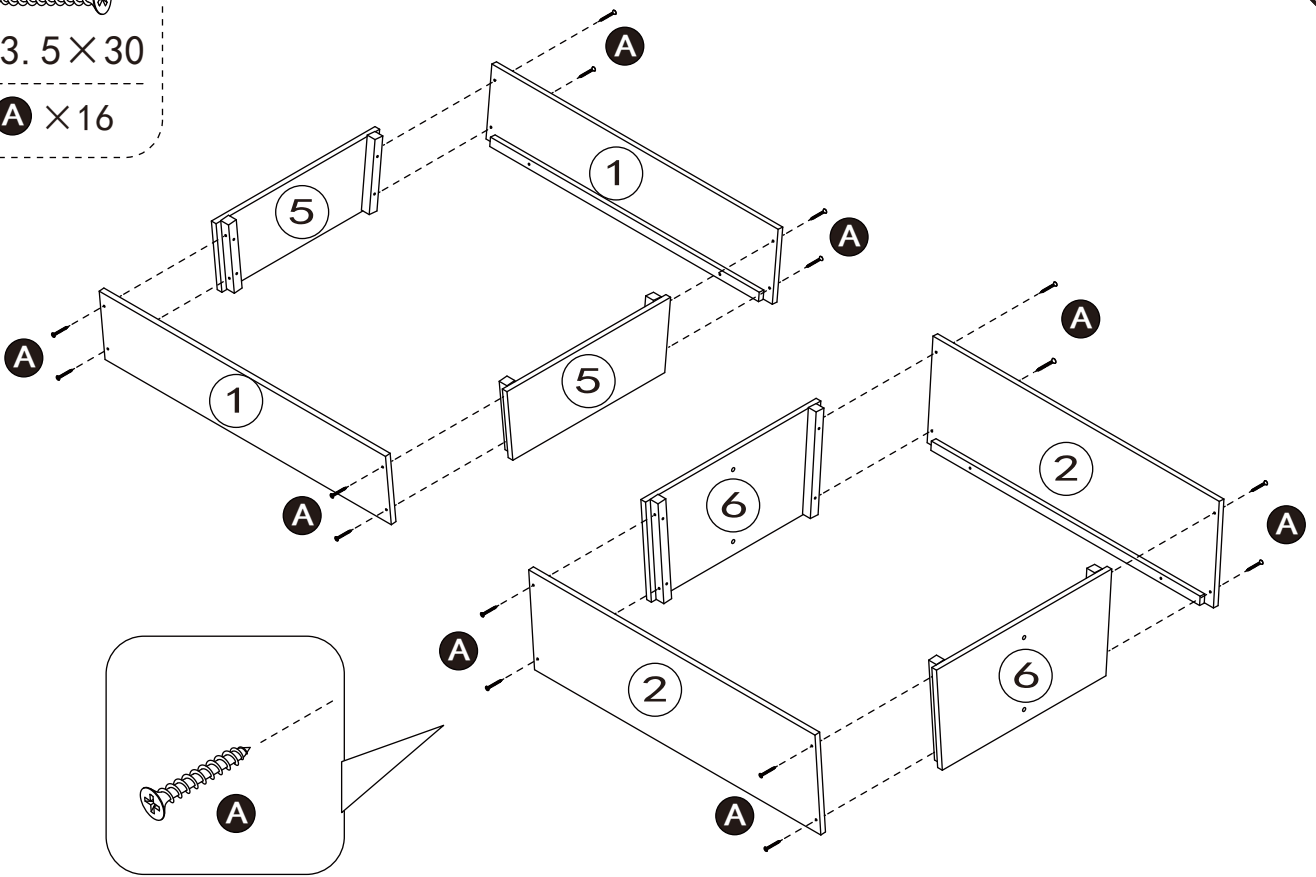

M6 x 20

B x 8

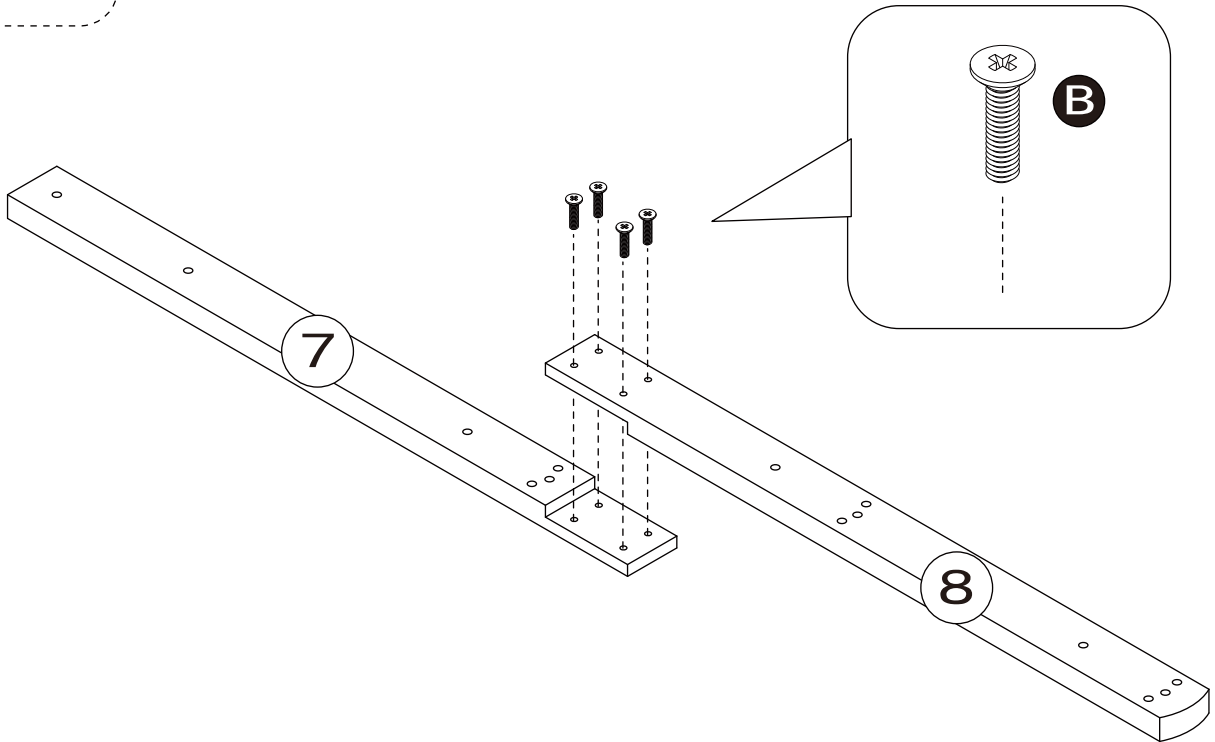

x2



M6 × 45

C × 4

