

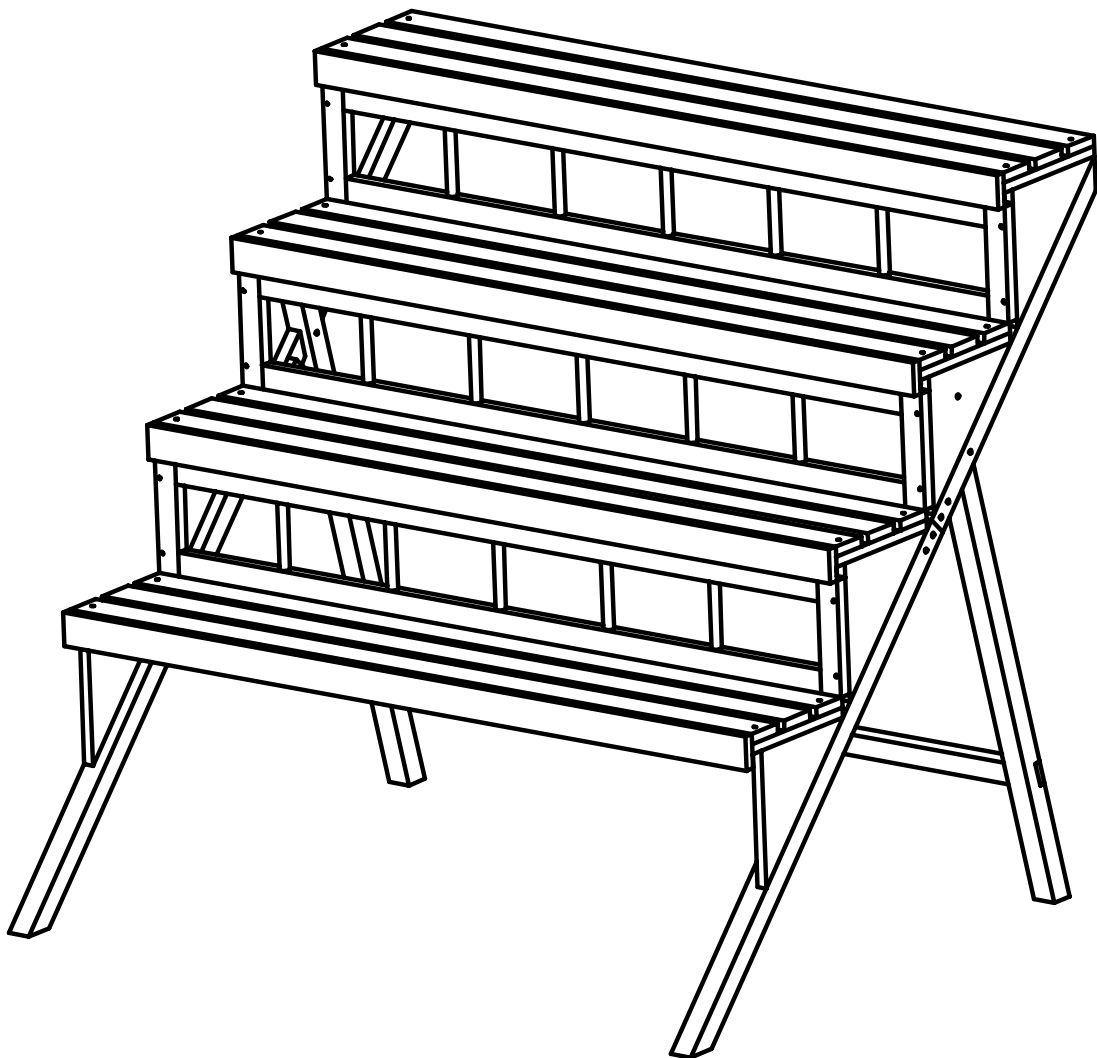

INbmc002V01_GL

845-441



IMPORTANT, RETAIN FOR FUTURE REFERENCE: READ CAREFULLY

ASSEMBLY & INSTRUCTION MANUAL

A x01

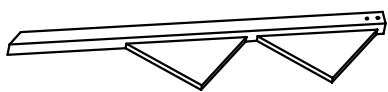

B x01

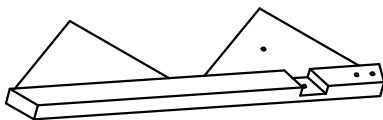

C x01

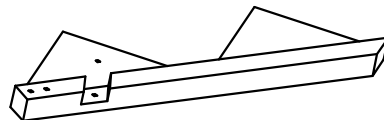

D x01

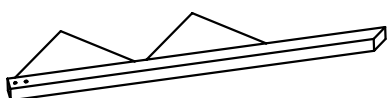

E x02

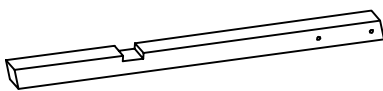

F x03

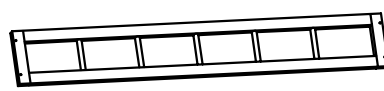

G x04



H x02

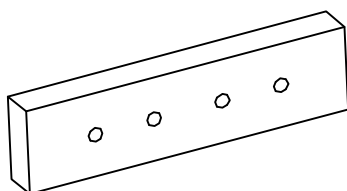

I x01

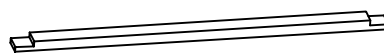

J x12
M6*50
+1(spare)



K x28
M3.5*40
+1(spare)

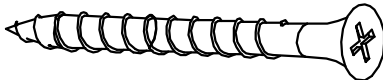

L x02
M3.5*30

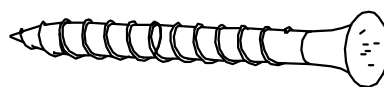

J x08
M6*50

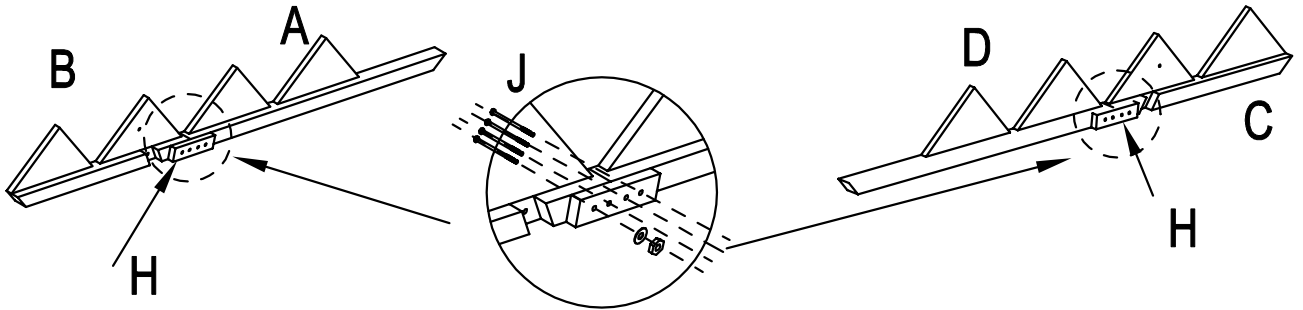

J x04
M6*50

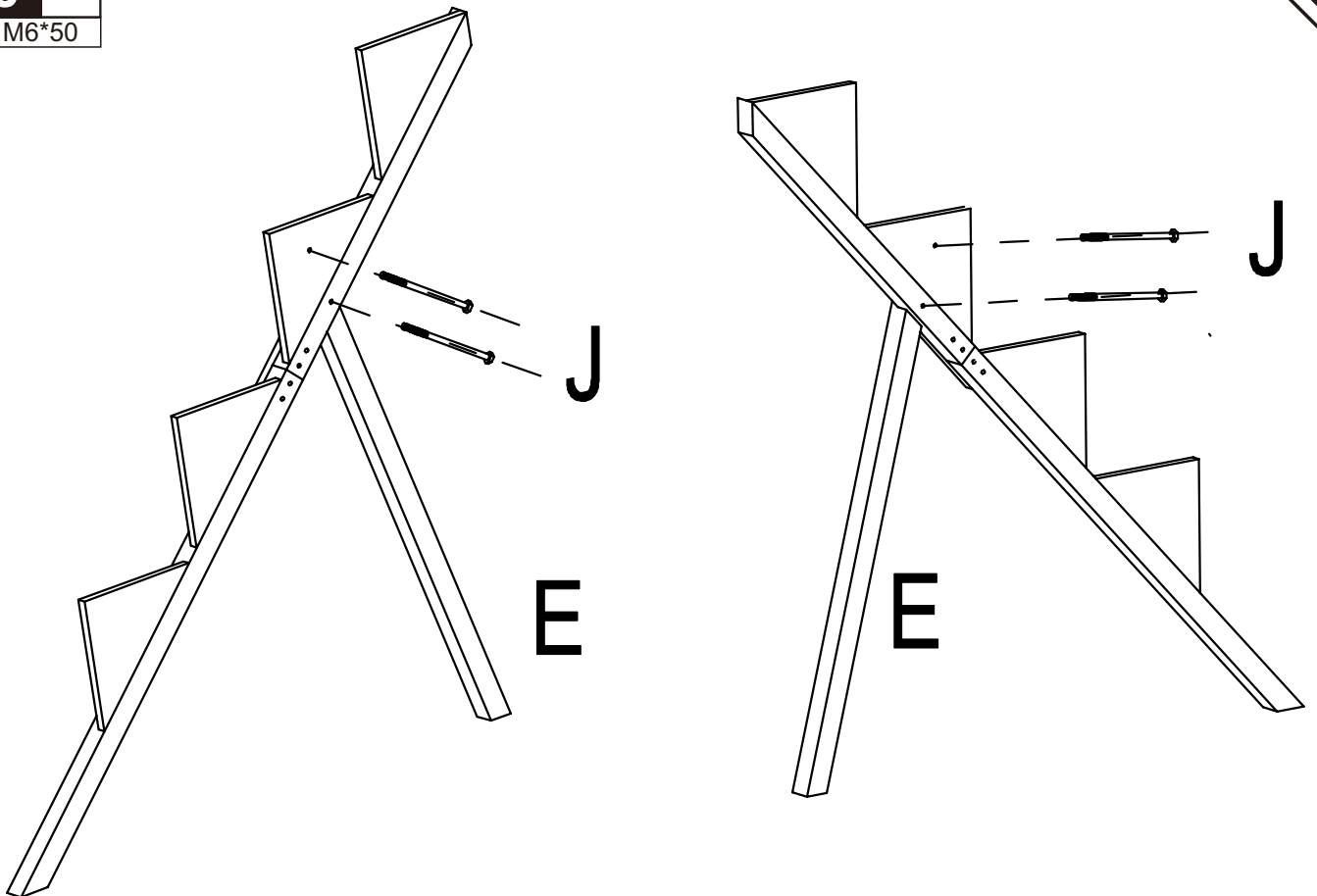

K x04
M3.5*40

L x02
M3.5*30

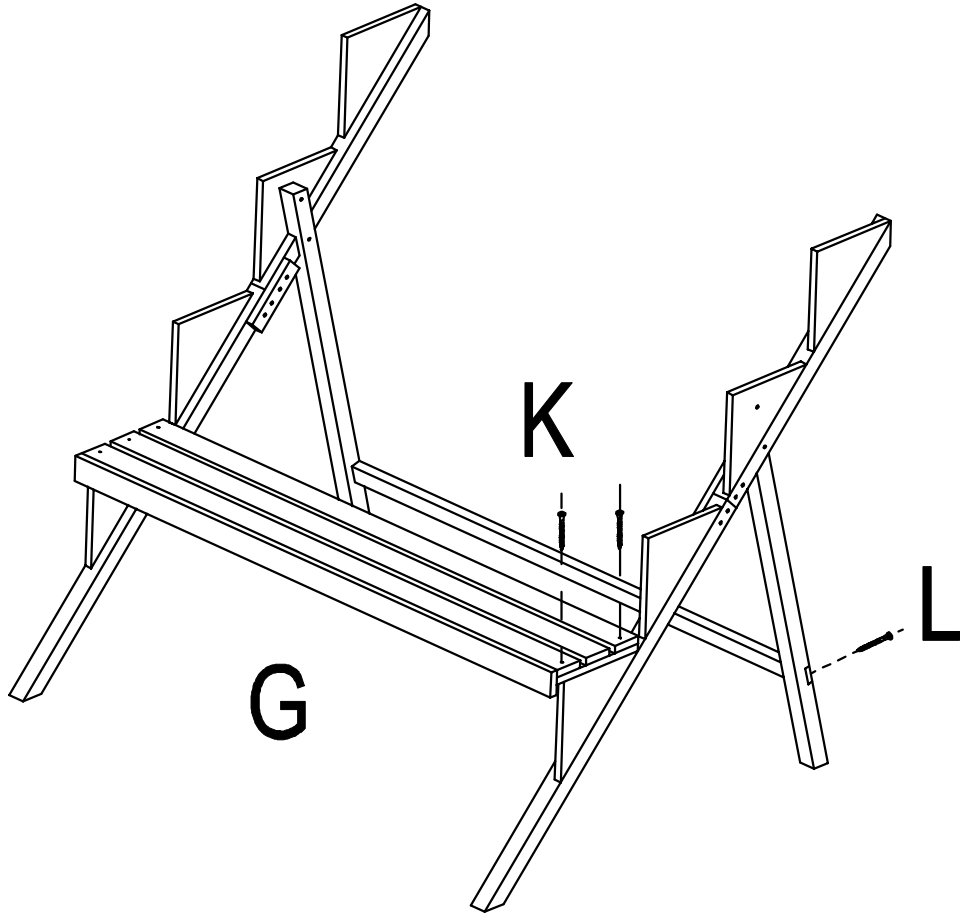

K x12
M3.5*40

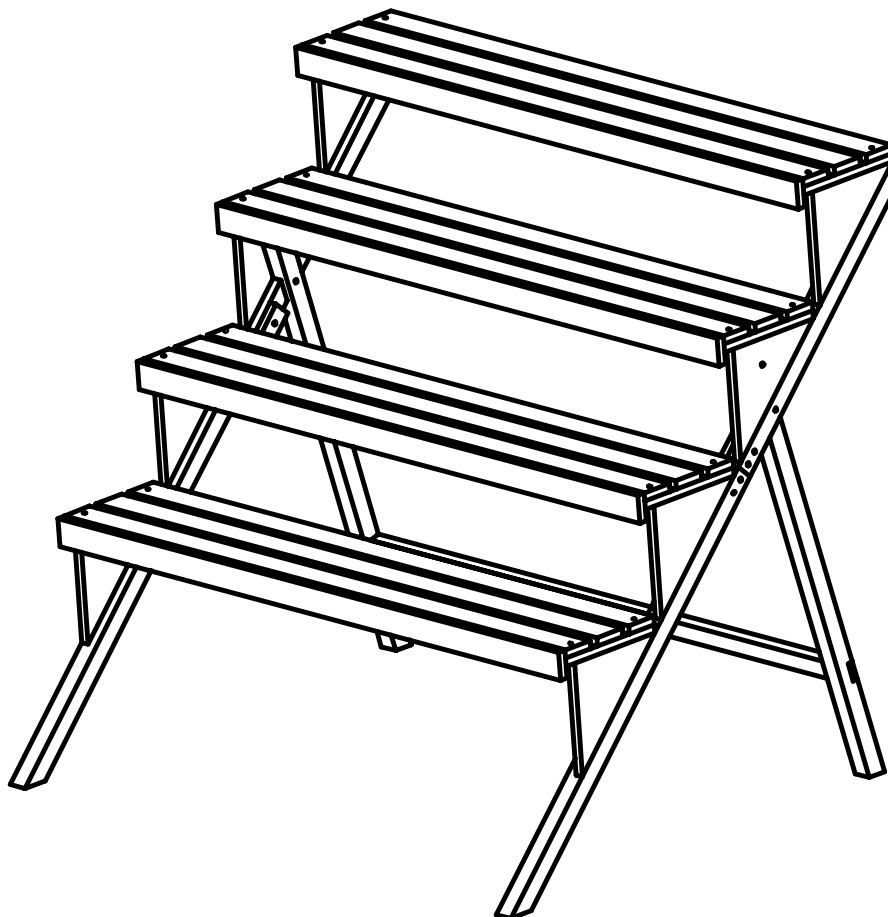

K x12
M3.5*40

