

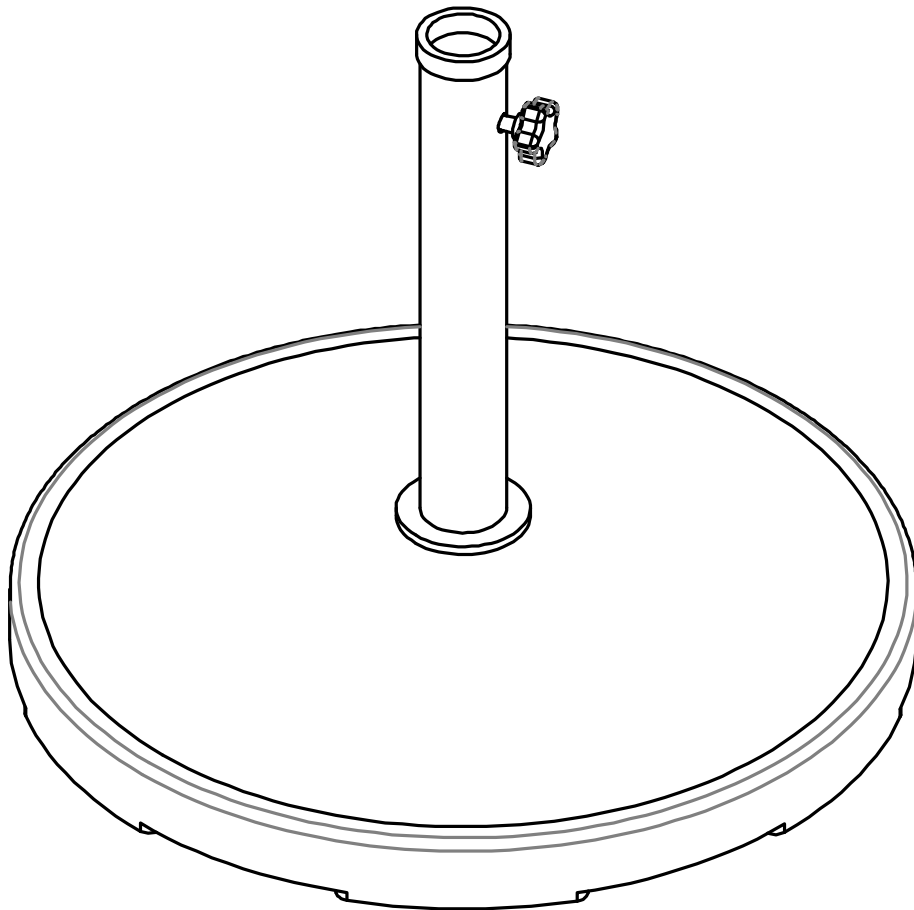

INbpb013V02\_GL

84D-044\_84D-045\_84D-046



IMPORTANT, RETAIN FOR FUTURE REFERENCE: READ CAREFULLY

ASSEMBLY & INSTRUCTION MANUAL

**PARTS**

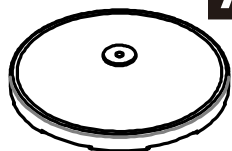

**A** x01



**B** x01

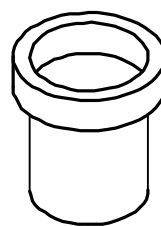

**C** x01

**HARDWARE**

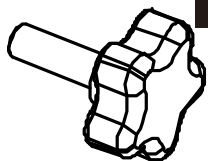

**D** x01

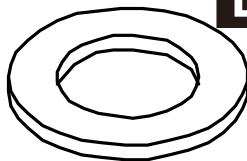

**E** x01

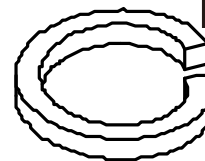

**F** x01

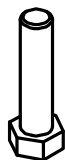

**G** x01



**H** x01

