

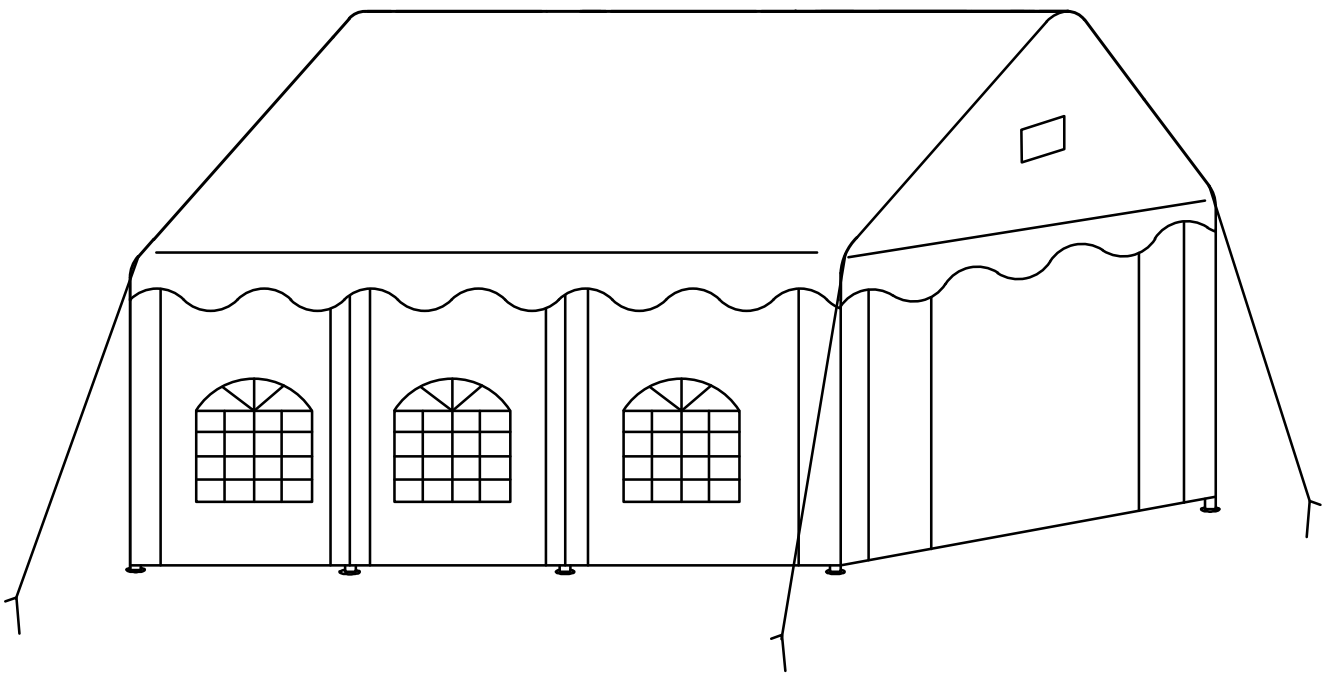

INbsb005V01_GL

84C-316





IMPORTANT, RETAIN FOR FUTURE REFERENCE: READ CAREFULLY

ASSEMBLY & INSTRUCTION MANUAL

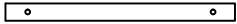
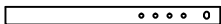





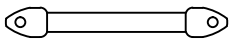
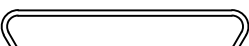



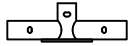
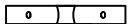

BOX 1/3

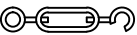
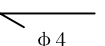
②		x15
③		x8

BOX 2/3

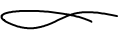
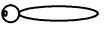
①		x8
④		x4
⑤		x4
⑥		x12

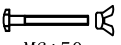
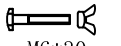
BOX 3/3

Ⓐ		x6
Ⓑ		x6
Ⓒ		x4
Ⓓ		x4
Ⓔ		x2
Ⓕ		x8
Ⓖ		x6
Ⓘ	 Φ 4	x55
Ⓙ		x1
Ⓚ		x6
Ⓛ		x1
Ⓜ		x1
Ⓟ		x4
Ⓠ		x99
Ⓠ1		x14
Ⓡ		x8
Ⓝ	 M6*50	x70
Ⓞ	 M6*30	x8
Ⓢ		x1

EN

1. A 3 person assembly is required for this tent.
2. Please take appropriate actions as heavy rain, wind and snow can damage the tent. If necessary please dis-assemble and store for later use.
3. In snowy conditions please do not allow the thickness of the snow to be more than 5cm on the roof, this should be cleared as soon as possible for your safety.

FR

1. 3 personnes minimum requis pour le montage de la tente.
2. Ne pas utiliser la tente en période de pluie, de vent et de neige qui peuvent endommager la tente. Nous ne serions pas responsable de la mauvaise utilisation du produit.
3. Pour votre sécurité, en période de neige, il est recommandé de ne pas laisser de neige de plus de 5cm sur le toit.

ES

1. Se requieren 3 personas para realizar el montaje de esta tienda de campaña.
2. Por favor, tome las medidas oportunas ya que la lluvia, el viento y la nieve pueden dañar la tienda. Si es necesario, desmonte la tienda y guárdela para su uso posterior.
3. En condiciones de nieve, no permita que la nieve tenga más de 5 cm de espesor en el techo, y retírela tan pronto como sea posible para su seguridad.

DE

1. Bauen Sie das Zelt mit Hilfe von 3 Personen auf.
2. Stellen Sie das Zelt auf einen ebenen Untergrund auf und achten Sie darauf, dass sich keine offenen Feuerstellen in der Nähe befinden.
3. Um Beschädigungen des Zeltes zu vermeiden, benutzen Sie es bitte nicht bei schlechten Wetterbedingungen wie starkem Regen, Wind oder Schneefällen. Für Schäden aufgrund schlechter Witterungsverhältnisse wird keine Haftung und Gewährleistung übernommen.
4. Bei Schneefall darf die Schneehöhe auf dem Dach 5 cm nicht überschreiten. Es obliegt Ihrer Verantwortung, das Zelt rechtzeitig und vorsichtig von der Schneelast zu befreien.
5. Sollten sich bei starkem Regen Wassertaschen auf dem Dach bilden, obliegt es Ihrer Verantwortung diese rechtzeitig und vorsichtig zu beseitigen.
6. Achten Sie beim Verstauen des Zeltes darauf alle Teile, insbesondere die Plane, vorher zu säubern und erst in trockenem Zustand einzupacken. Lagern Sie das Zelt an einem trockenen Ort.
7. Prüfen Sie vor Wiederaufbau des Zeltes die Vollständigkeit und Funktionalität aller für den Aufbau benötigten Teile.

IT

1. Per assemblare questa tenda sono necessarie 3 persone
2. Si prega di prendere le precauzioni necessaria in quanto pioggia, vento e neve possono danneggiare la tenda. Se necessario si prega di smontarla e conservarla per uso futuro.
3. Qualora nevicasse si prega di non lasciare che lo strato di neve sopra la tenda sia spesso oltre i 5cm, anzi la neve va rimossa al più' presto per la vostra sicurezza.

PT

1. Para a montagem desta tenda de campismo são necessárias 3 pessoas.
2. Tome medidas adequadas, em caso de vento forte, chuva ou neve, pois estas podem danificar a tenda. Caso seja necessário, desmonte e armazene a tenda de campismo para uso posterior.
3. Em caso de neve, não permita que a espessura da neve seja superior a 5cm no teto. Para a sua segurança, retire a neve o mais rápido possível

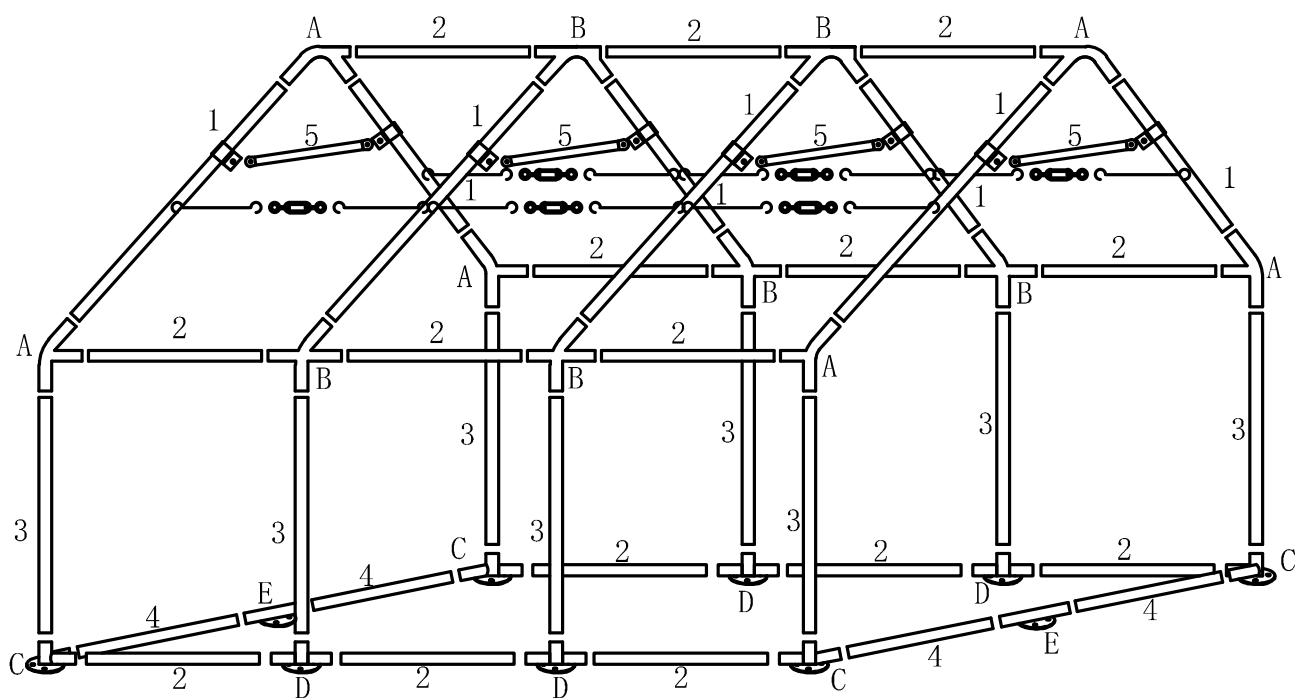
$3 \times 6M$ 

① x 8

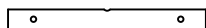

② x 15

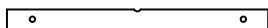

③ x 8

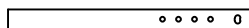

④ x 4



⑤ x 4

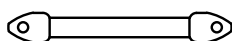

A x 6



B x 6



C x 4

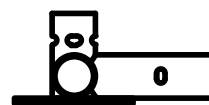

D x 4

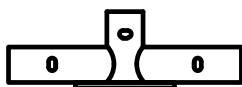

E x 2



F x 8



G x 12

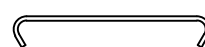

I x 55
Φ4



J x 1



K x 6

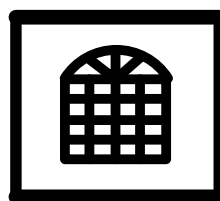

L x 1



M x 1



P x 4



Q x 99



Q1 x 14



R x 8

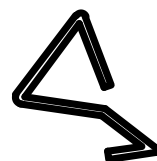

H x 6



N x 70
M6*50
+1(spare)



O x 8
M6*30
+1(spare)



S x 1



01

N x 34
M6*50

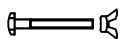

H x 6

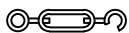

O x 8
M6*30

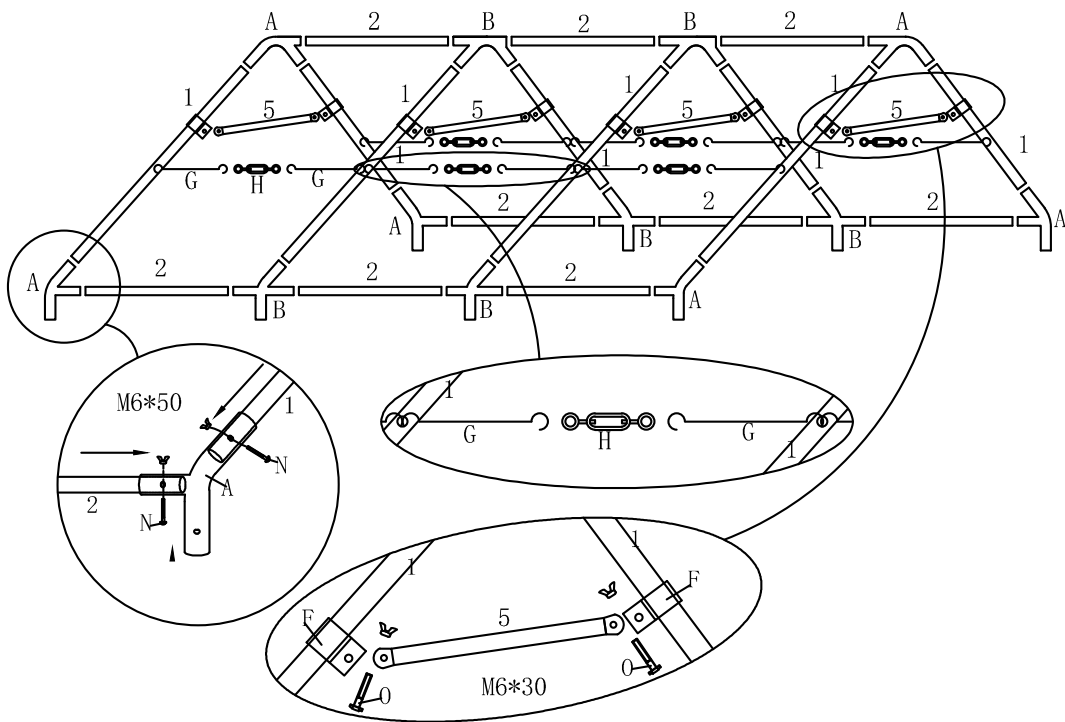
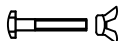

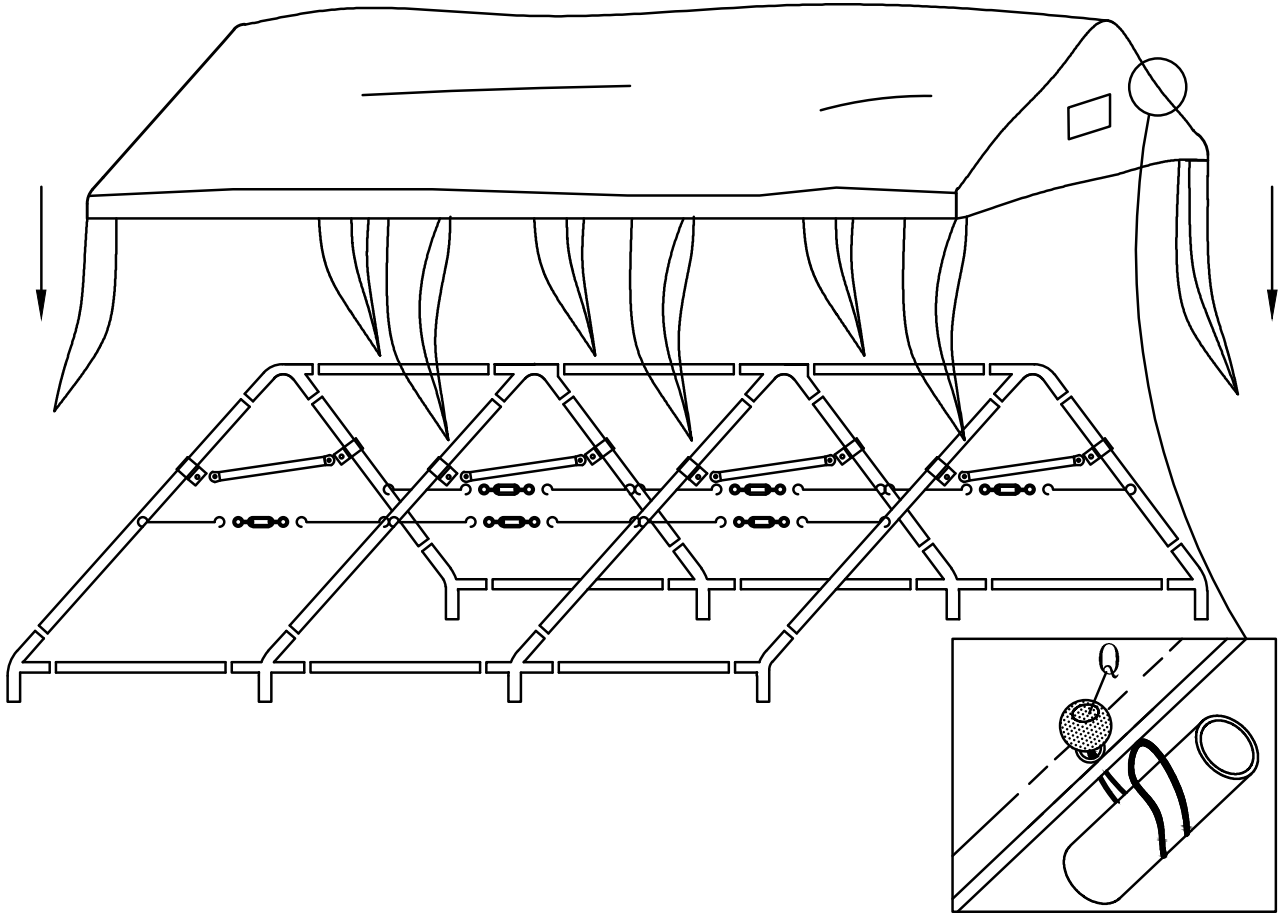

N x 36
M6*50

