

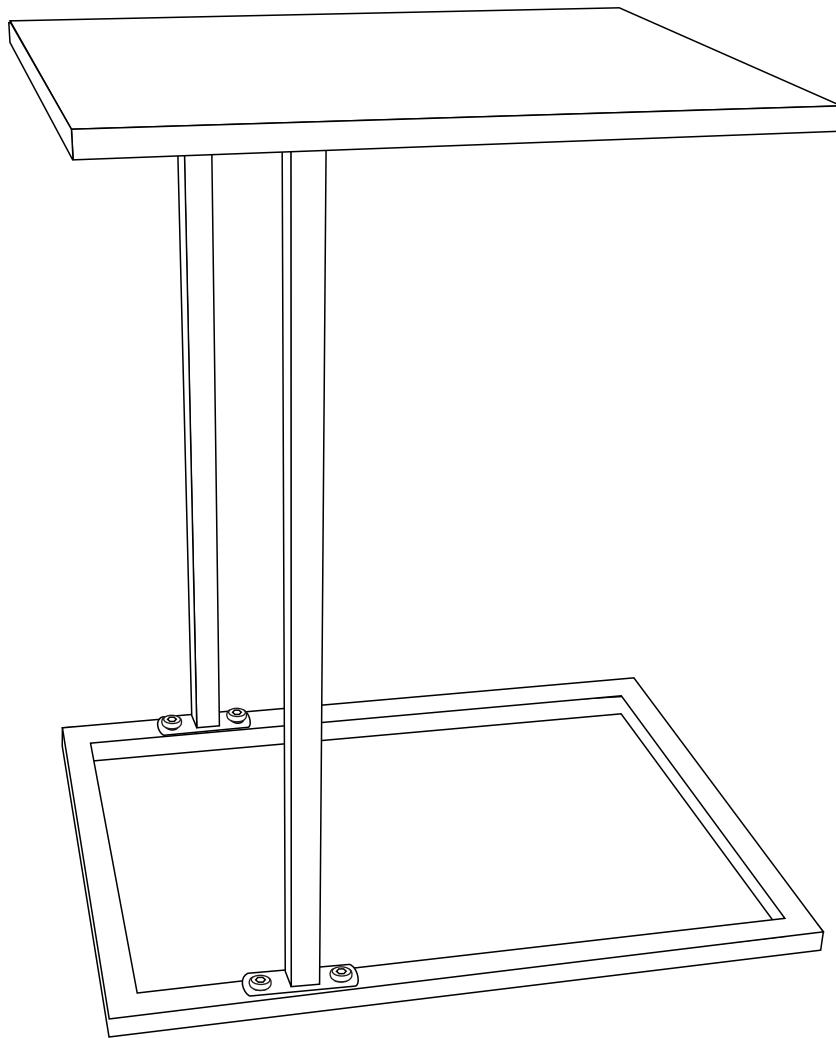

INbte007V01_GL

84B-512



IMPORTANT, RETAIN FOR FUTURE REFERENCE: READ CAREFULLY

ASSEMBLY & INSTRUCTION MANUAL

A x 1

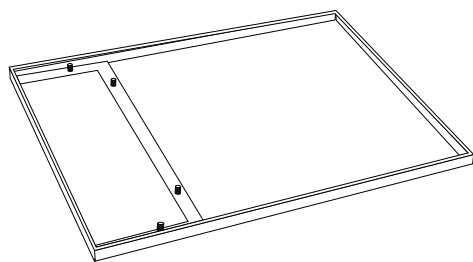

B x 1

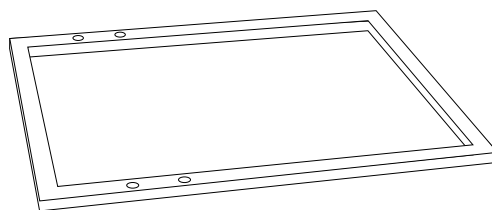

C x 1

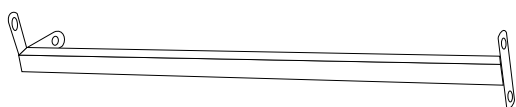

D x 1

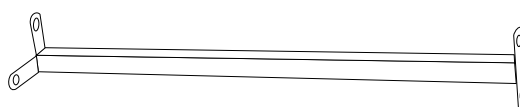

E x 4

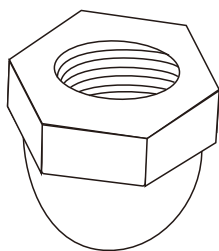

F x 4

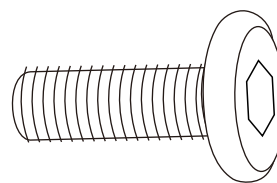

G x 1

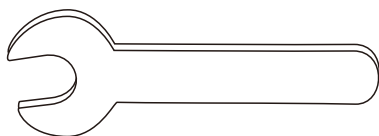

H x 1



