

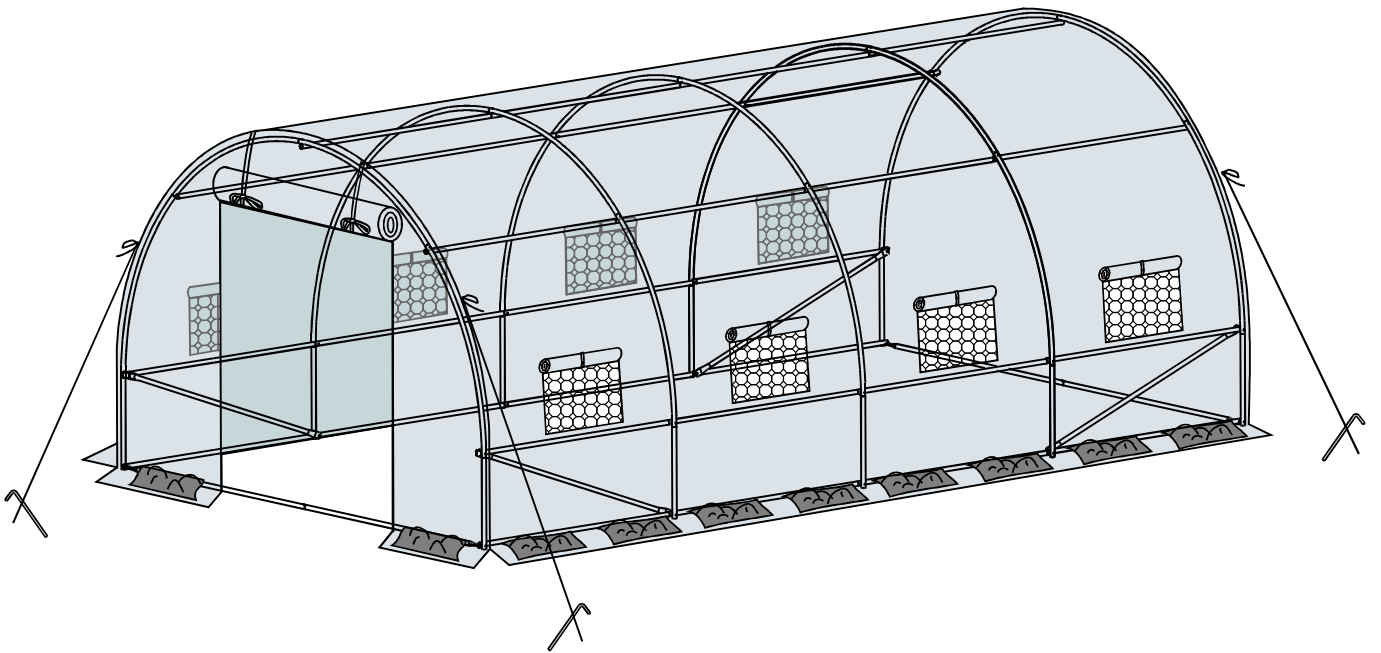

INbwa024_GL

845-612V01



120MIN

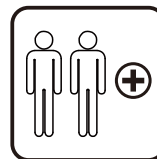

IMPORTANT, RETAIN FOR FUTURE REFERENCE: READ CAREFULLY

Tools Recommended

ASSEMBLY & INSTRUCTION MANUAL

PARTS

1 x15



2 x 5



3 x10

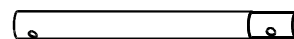

4 x 7

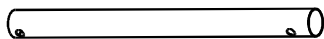

5 x14

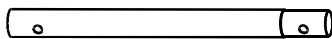

6 x 7

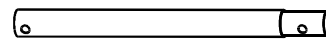

7 x 2

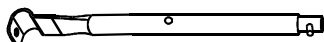

8 x 2

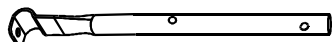

10 x 4

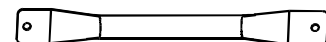

HARDWARE

H x35
M6*50
+1(spare)

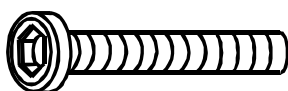

K x35
+1(spare)

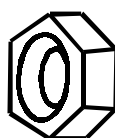

A x14
+1(spare)



B x 4

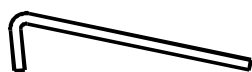

C x 4



D x 1



- 1 x6
- 2 x2
- 5 x3
- 6 x3
- A x3
- H x6
- K x6

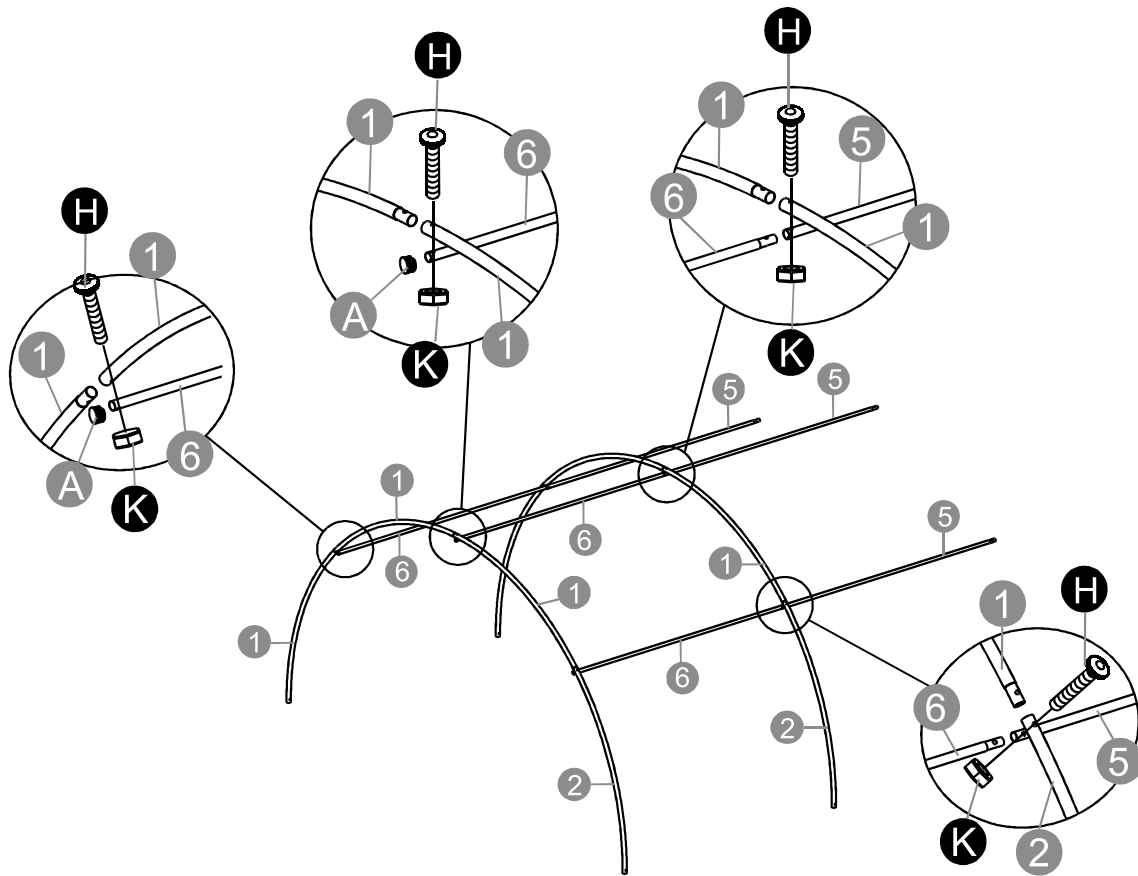

- 3 x4
- 5 x4
- 6 x4
- 7 x1
- 8 x1
- 10 x2
- A x4
- H x8
- K x8

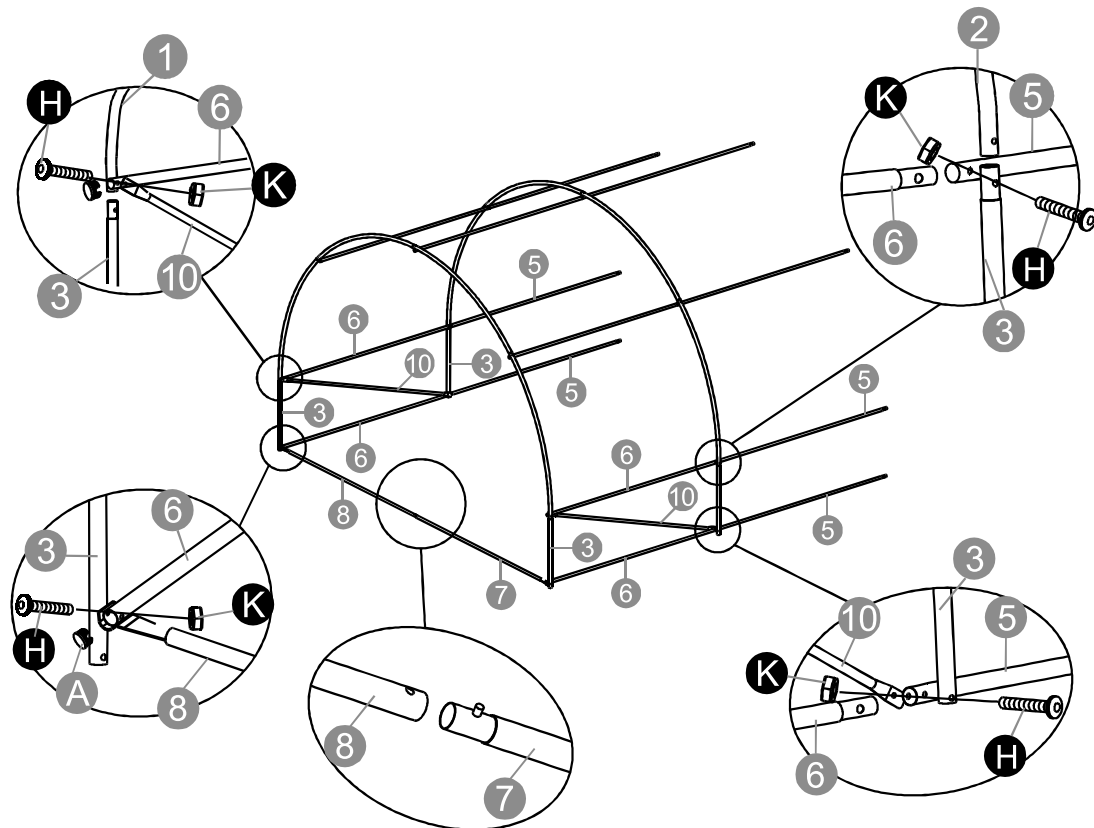

- 1 x3
- 2 x1
- 3 x2
- 5 x7
- H x7
- K x7

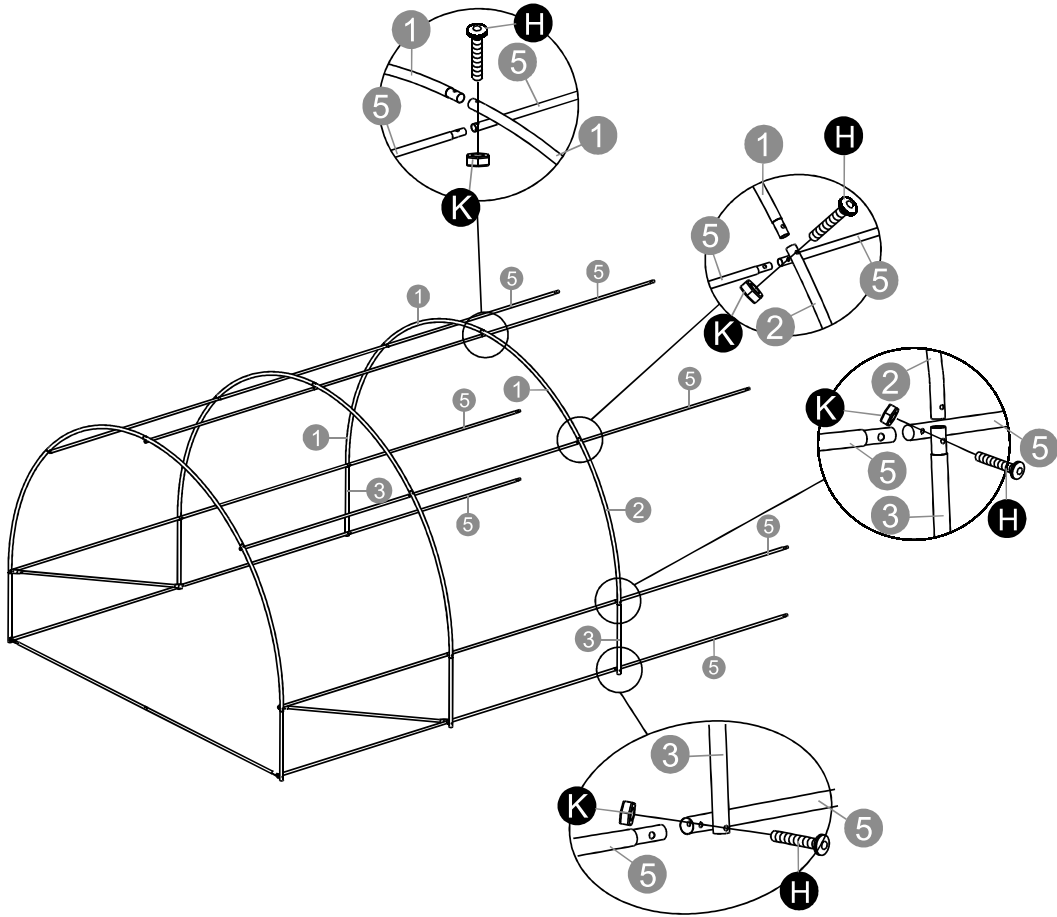

- 1 x3
- 2 x1
- 3 x2
- 4 x7
- 10 x2
- H x7
- K x7

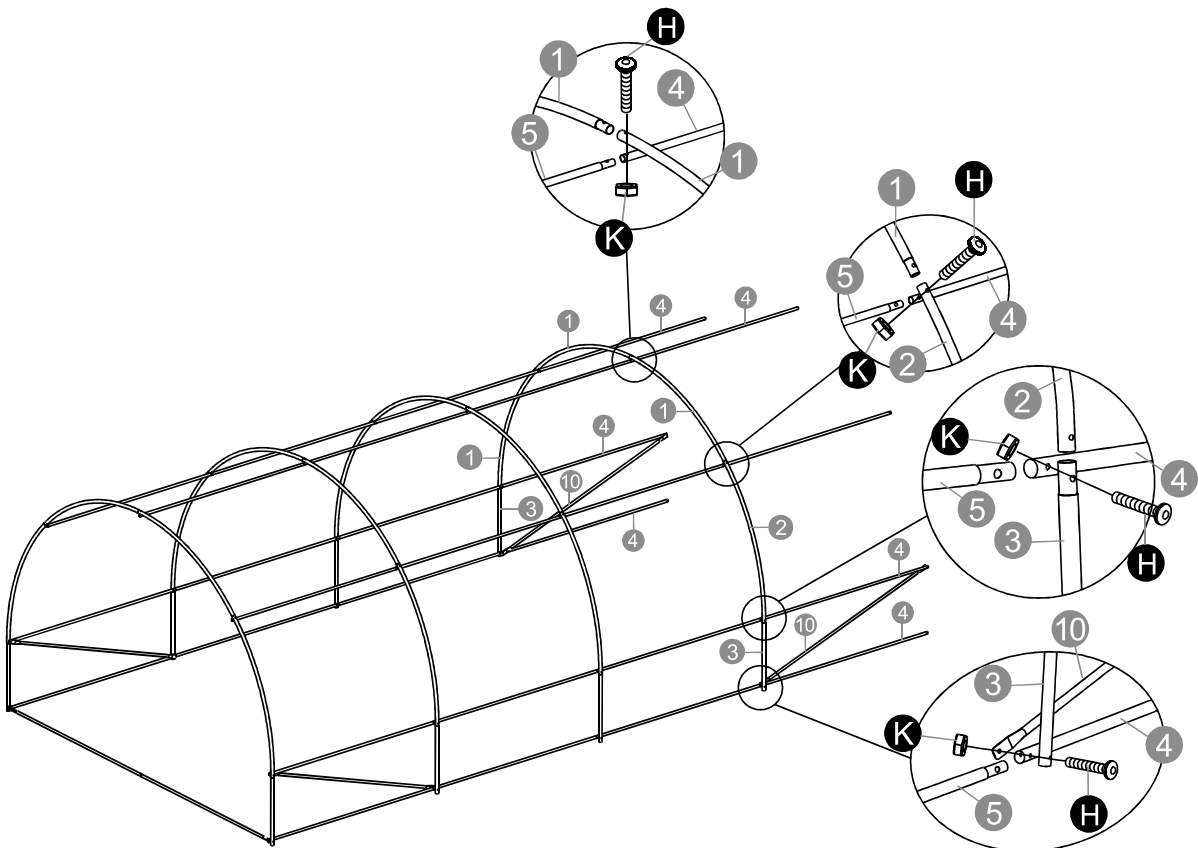

- 1 x3
- 2 x1
- 3 x2
- 7 x1
- 8 x1
- H x7
- K x7

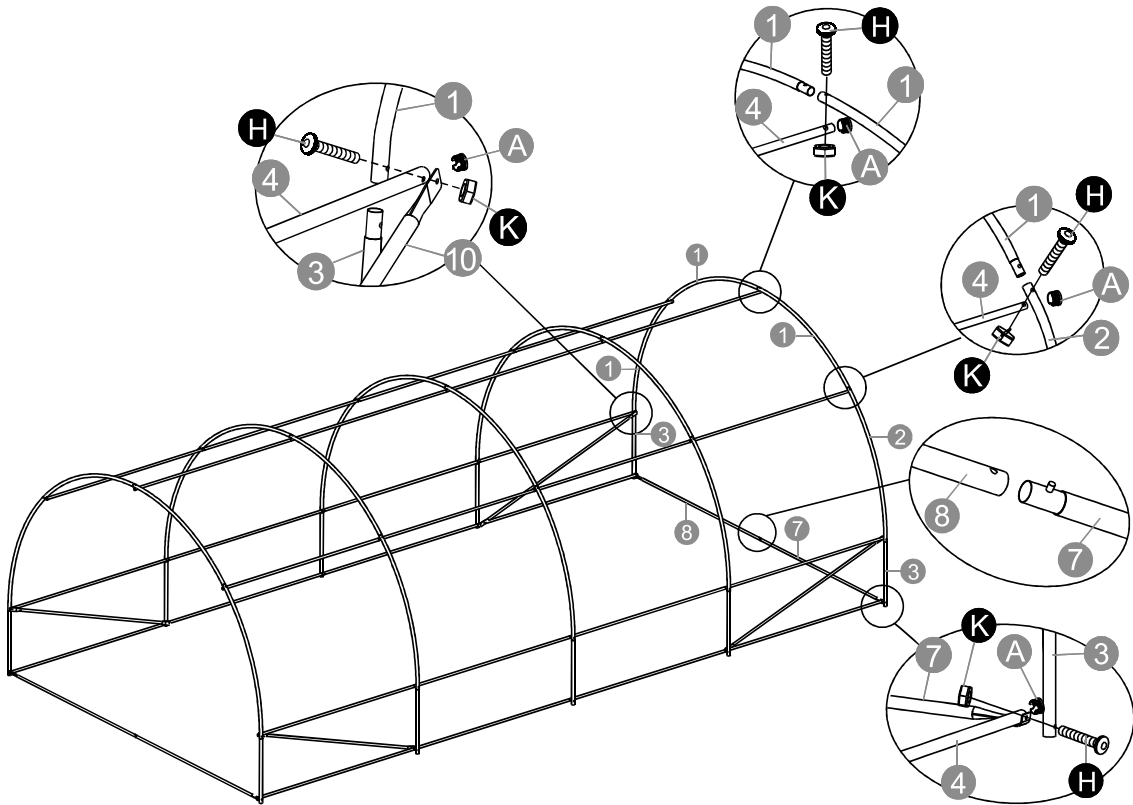

- B x4
- C x4
- D x1

