

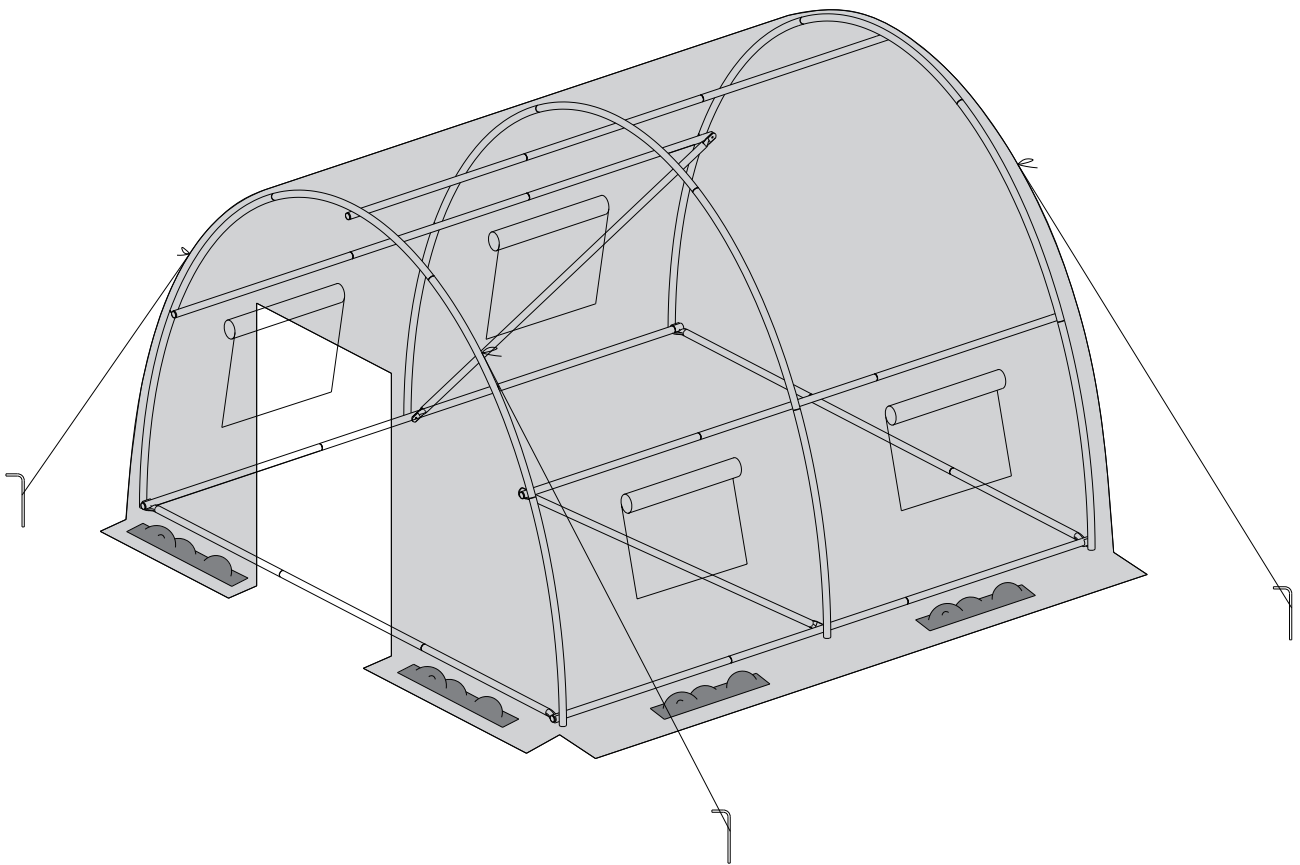











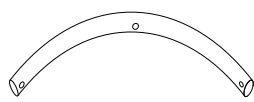
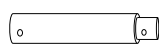
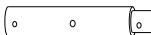

INbwa026_GL

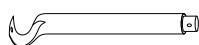
845-619

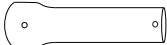



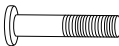
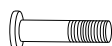

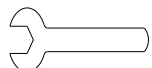

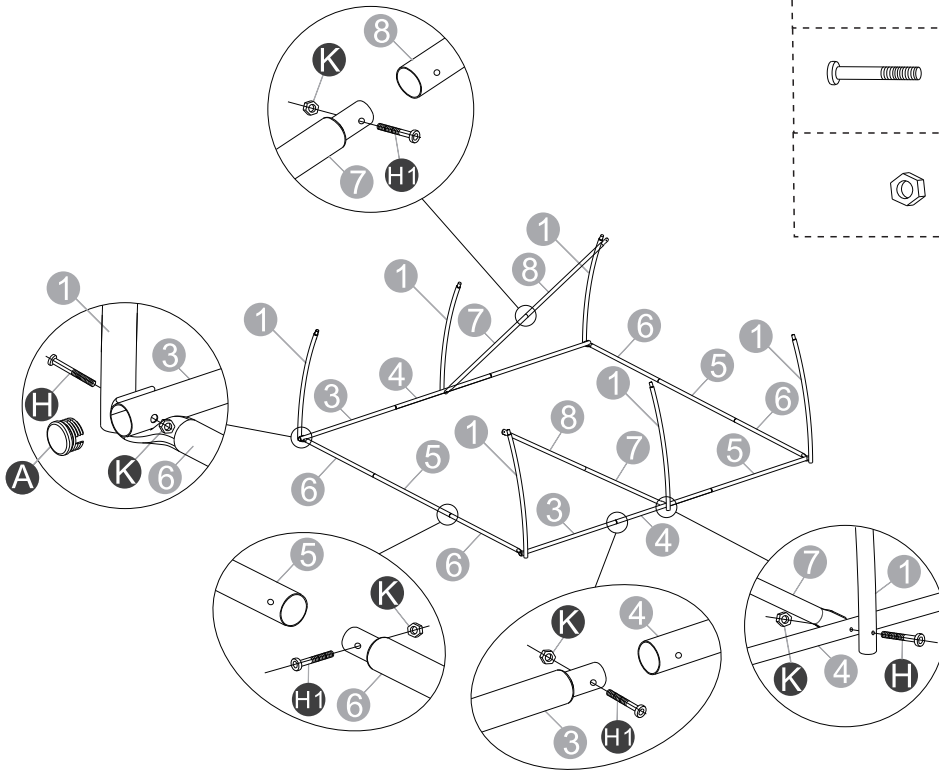

IMPORTANT, RETAIN FOR FUTURE REFERENCE: READ CAREFULLY

ASSEMBLY & INSTRUCTION MANUAL

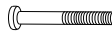
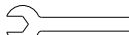
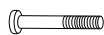
 <p>1 x12</p>	 <p>2 x 3</p>	 <p>3 x 5</p>
 <p>4 x 5</p>	 <p>5 x 7</p>	 <p>6 x 4</p>
 <p>7 x 2</p>	 <p>8 x 2</p>	
 <p>A x10</p>	 <p>B x 4</p>	 <p>C x 4</p>
 <p>D x 1</p>	 <p>H x15 +1(spare) M6X52</p>	 <p>H1 x22 +1(spare) M6X30</p>
 <p>K x37 +1(spare)</p>	 <p>L x 1</p>	 <p>M x 1</p>



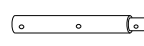
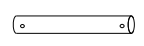
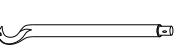

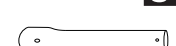

①

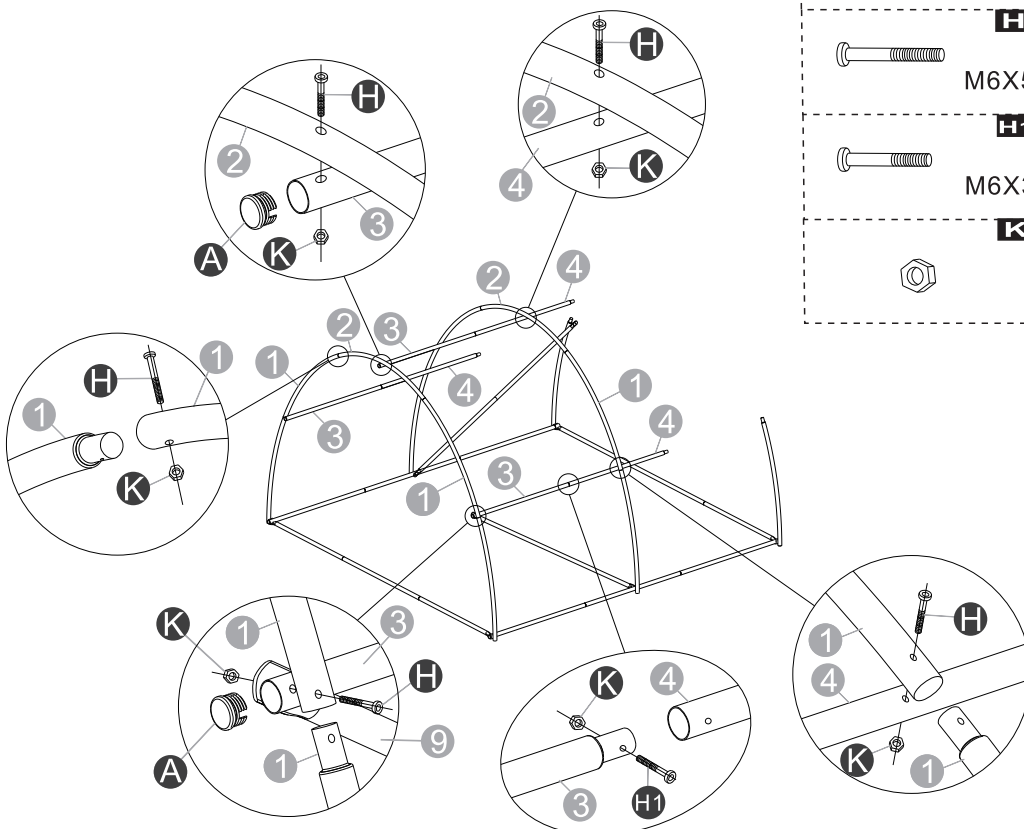

	A x 4		L x 1
	H x 6 M6X52		M x 1
	H1 x 10 M6X30		1 x 6
	K x 16		3 x 2
			4 x 2
			5 x 4
			6 x 4
			7 x 2
			8 x 2

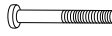
②

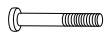

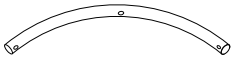
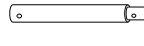
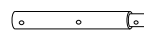
	A x 3		L x 1
	H x 6 M6X52		M x 1
	H1 x 7 M6X30		1 x 4
	K x 13		2 x 2
			3 x 3
			4 x 3

③

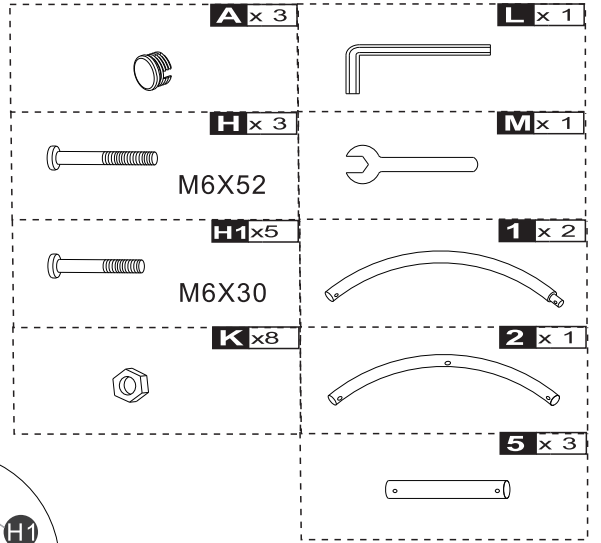
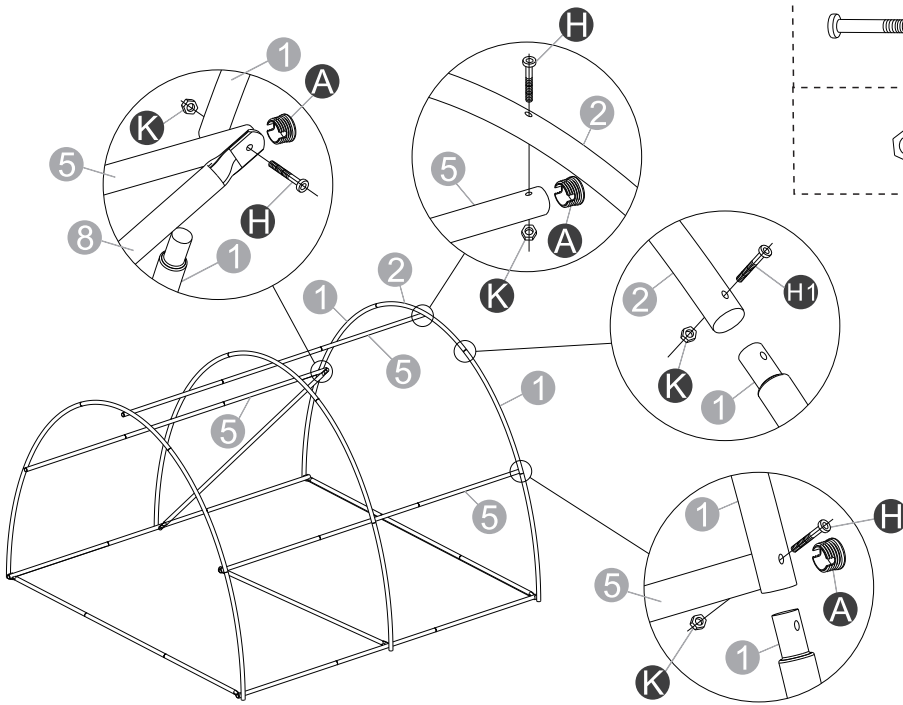

④

