

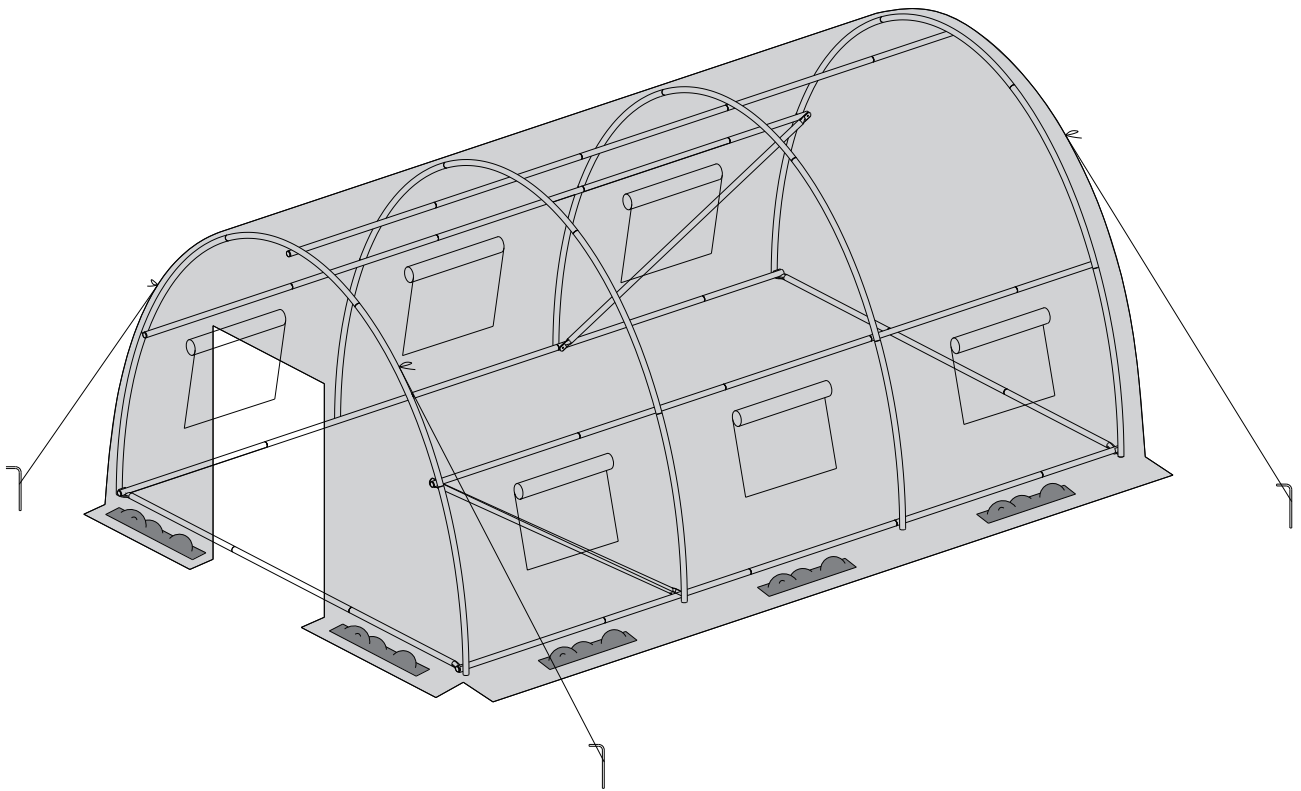













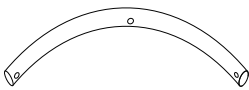

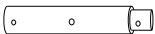

INbwa027\_GL

**845-619V01**

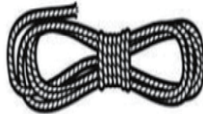

**IMPORTANT, RETAIN FOR FUTURE REFERENCE: READ CAREFULLY**

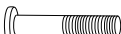
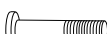
# ASSEMBLY & INSTRUCTION MANUAL

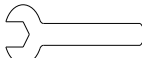
 <p><b>1</b> x16</p>	 <p><b>2</b> x 4</p>	 <p><b>3</b> x15</p>
 <p><b>4</b> x 5</p>	 <p><b>5</b> x 2</p>	 <p><b>6</b> x4</p>
 <p><b>7</b> x 2</p>	 <p><b>8</b> x 2</p>	 <p><b>9</b> x 5</p>
 <p><b>A</b> x10</p>	 <p><b>B</b> x 4</p>	 <p><b>C</b> x4</p>
 <p><b>D</b> x 1</p>	 <p><b>H</b> x20 +1(spare) M6X52</p>	 <p><b>H1</b> x29 +1(spare) M6X30</p>
 <p><b>K</b> x49 +1(spare)</p>	 <p><b>L</b> x 1</p>	 <p><b>M</b> x 1</p>

1

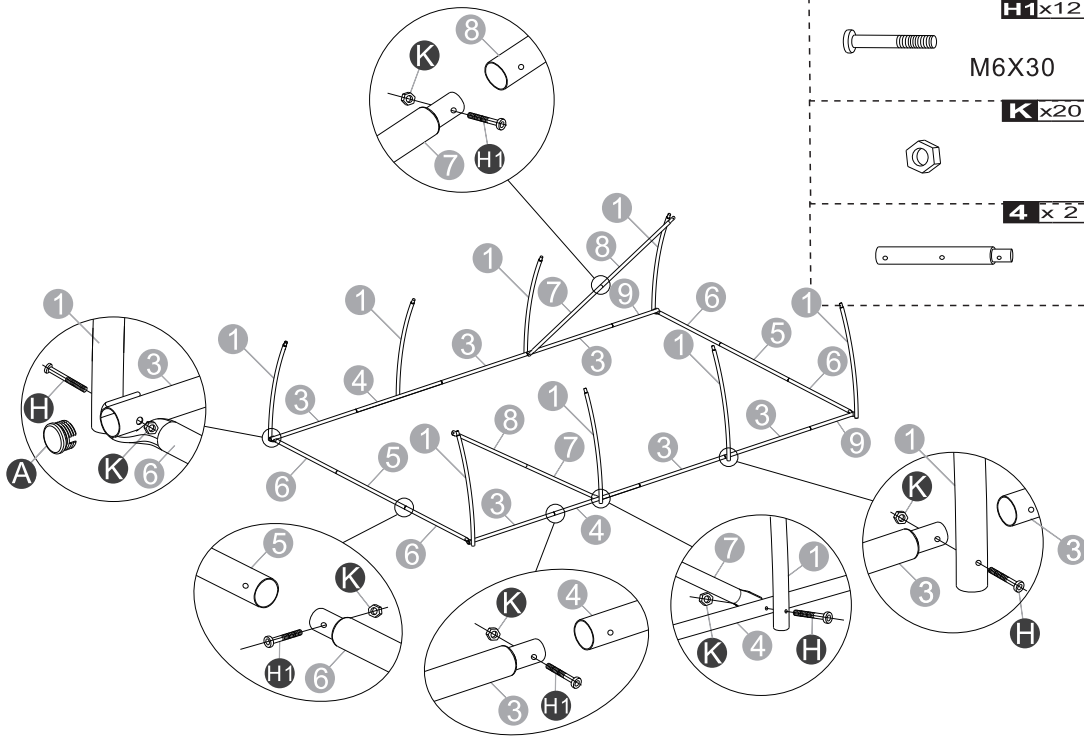

<b>A</b> x 4	<b>L</b> x 1
<b>H</b> x 8	<b>M</b> x 1
M6X52	
<b>H1</b> x 12	<b>1</b> x 8
M6X30	
<b>K</b> x 20	<b>3</b> x 6
<b>4</b> x 2	<b>5</b> x 2
<b>6</b> x 4	
<b>7</b> x 2	
<b>8</b> x 2	
<b>9</b> x 2	

2

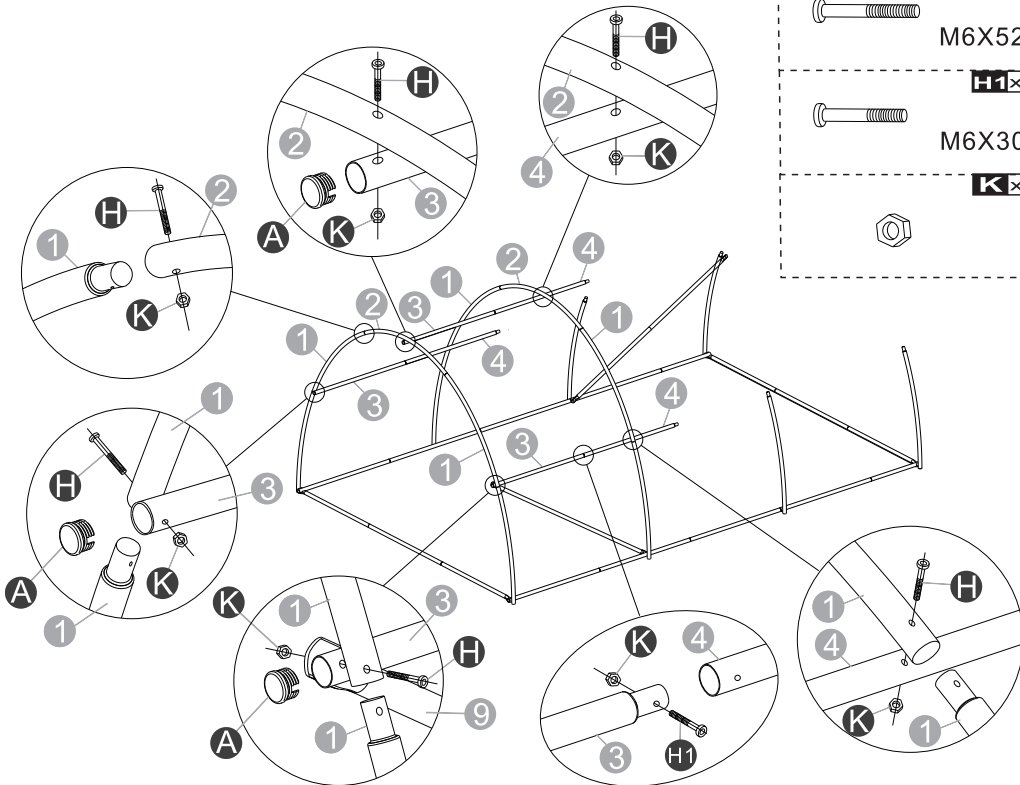

<b>A</b> x 3	<b>L</b> x 1
<b>H</b> x 6	<b>M</b> x 1
M6X52	
<b>H1</b> x 7	<b>1</b> x 4
M6X30	
<b>K</b> x 13	<b>2</b> x 2
<b>3</b> x 3	
<b>4</b> x 3	

3

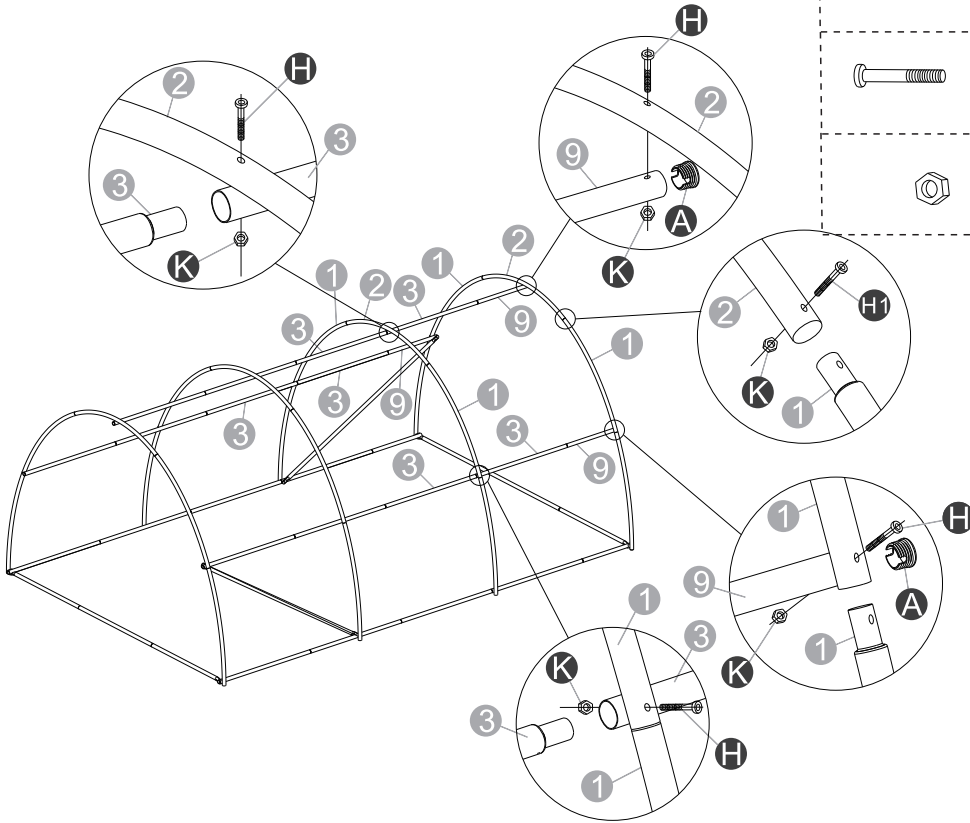

<b>A</b> x 3		<b>L</b> x 1	
<b>H</b> x 6		<b>M</b> x 1	
<b>H1</b> x 10		<b>1</b> x 4	
<b>K</b> x 16		<b>2</b> x 2	
		<b>3</b> x 6	
		<b>9</b> x 3	

4

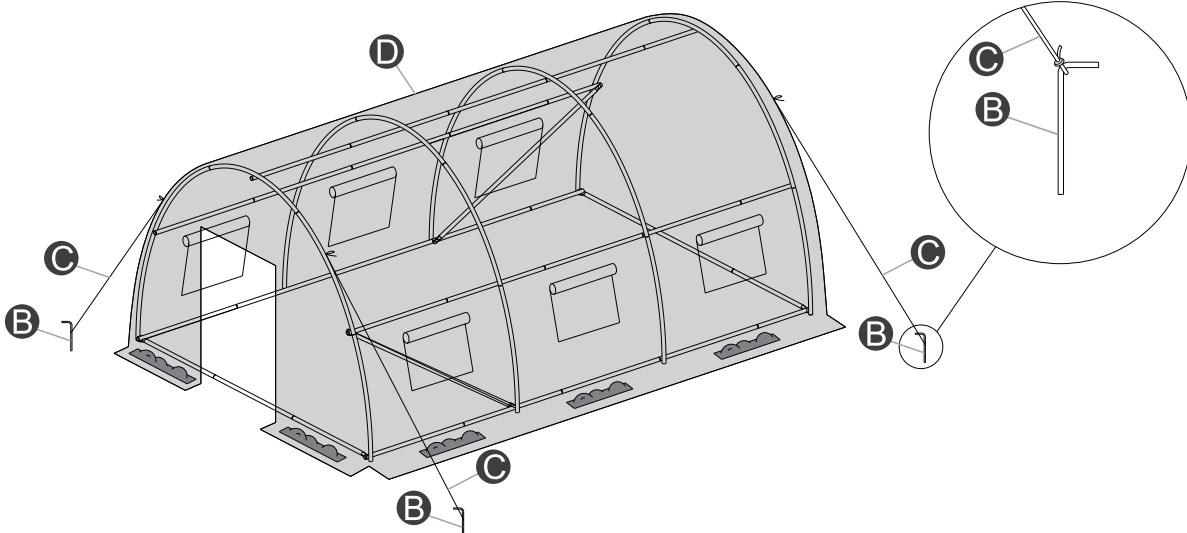

<b>B</b> x 4	
<b>C</b> x 4	
<b>D</b> x 1	