

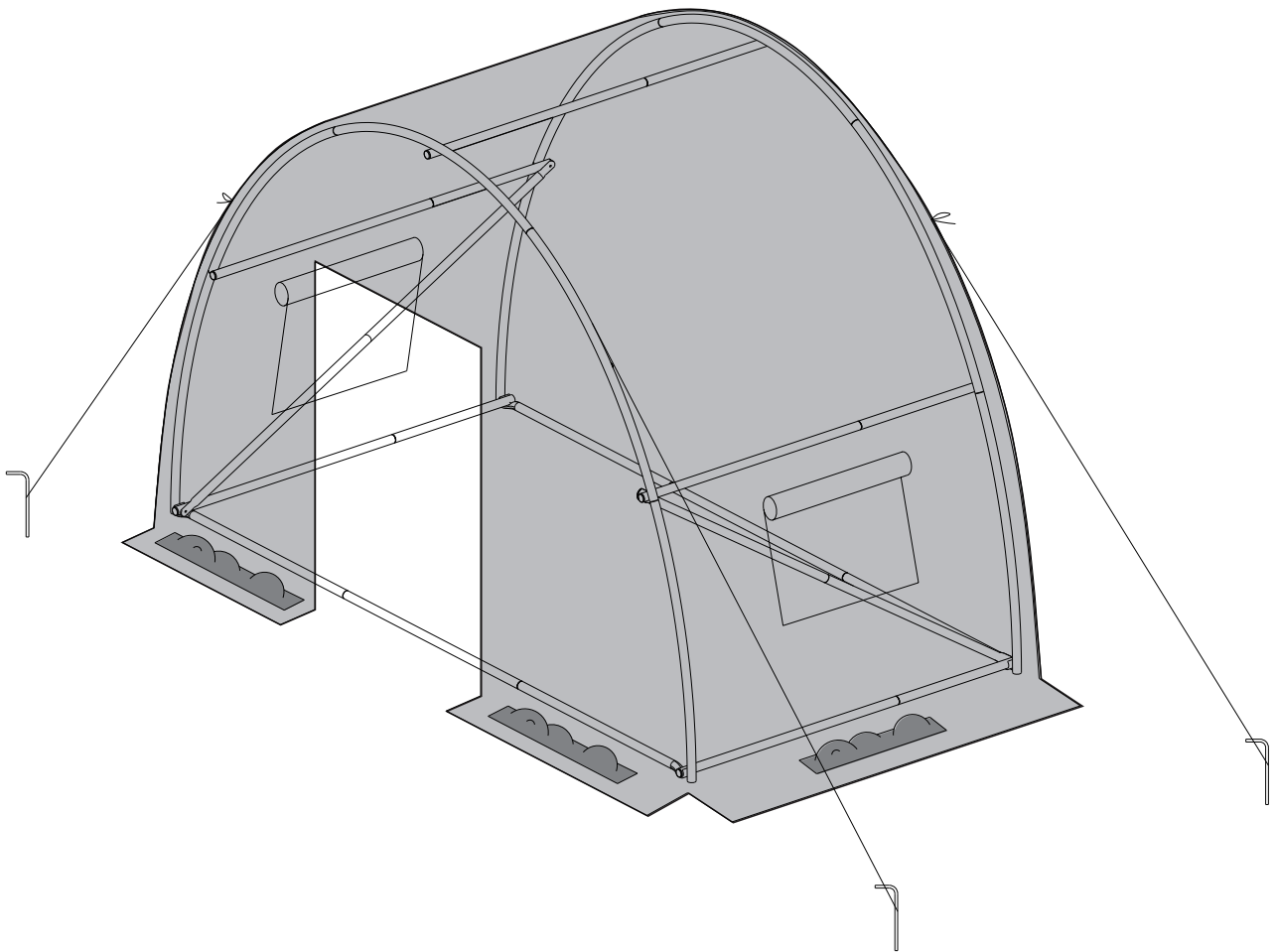











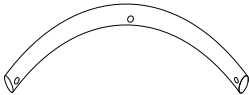

INbwb011\_GL

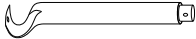
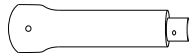
**845-591**



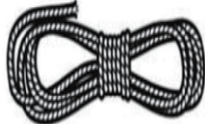

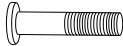
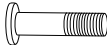

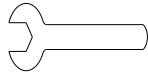



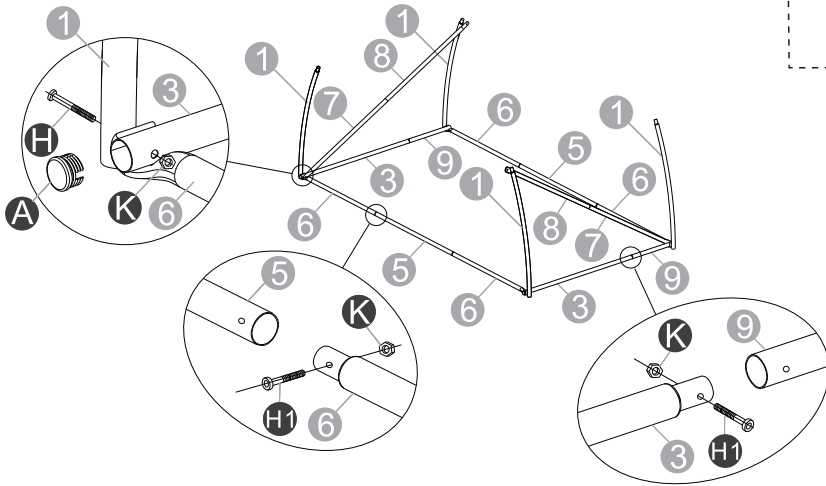

**IMPORTANT, RETAIN FOR FUTURE REFERENCE: READ CAREFULLY**

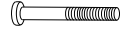
# ASSEMBLY & INSTRUCTION MANUAL

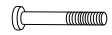
<p><b>1 x 8</b></p> 	<p><b>2 x 2</b></p> 	<p><b>3 x 5</b></p> 
<p><b>5 x 2</b></p> 	<p><b>6 x 4</b></p> 	<p><b>7 x 2</b></p> 
<p><b>8 x 2</b></p> 	<p><b>9 x 5</b></p> 	
<p><b>A x 10</b></p> 	<p><b>B x 4</b></p> 	<p><b>C x 4</b></p> 
<p><b>D x 1</b></p> 	<p><b>H x 10</b> +1(spare)</p>  <p><b>M6X52</b></p>	<p><b>H1 x 15</b> +1(spare)</p>  <p><b>M6X30</b></p>
<p><b>K x 25</b> +1(spare)</p> 	<p><b>L x 1</b></p> 	<p><b>M x 1</b></p> 





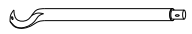
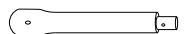
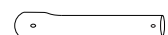

①

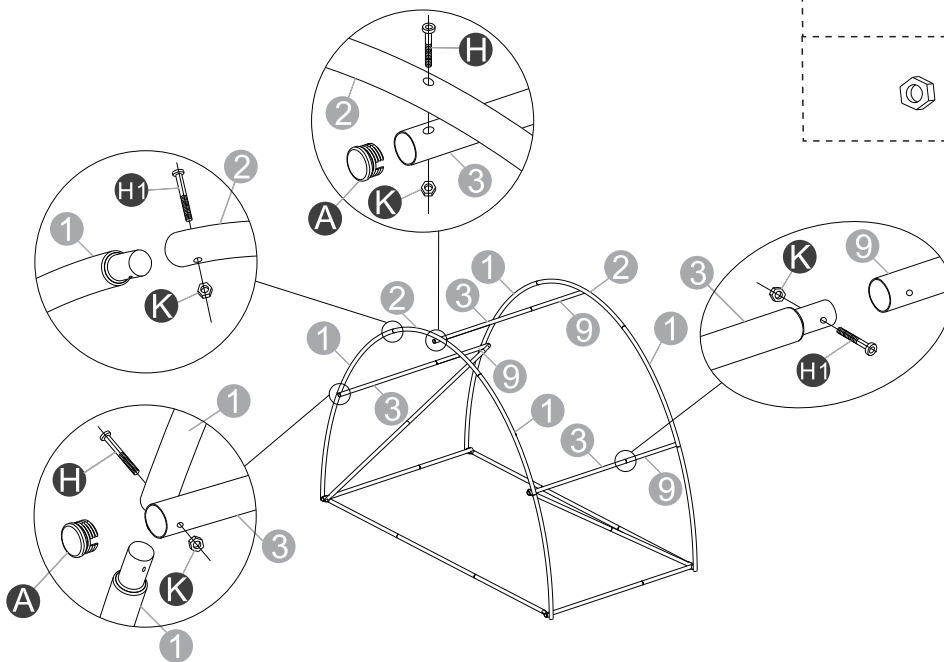

	<b>A x 4</b>		<b>L x 1</b>
	<b>H x 4</b>		<b>M x 1</b>
	<b>H1 x 8</b>		<b>1 x 4</b>
	<b>K x 12</b>		<b>3 x 2</b>
			<b>5 x 2</b>
			<b>6 x 4</b>
			<b>7 x 2</b>
			<b>8 x 2</b>
			<b>9 x 2</b>

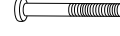
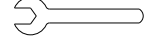
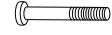
②

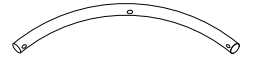
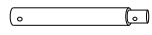

	<b>A x 6</b>		<b>L x 1</b>
	<b>H x 6</b>		<b>M x 1</b>
	<b>H1 x 7</b>		<b>1 x 4</b>
	<b>K x 13</b>		<b>2 x 2</b>
			<b>3 x 3</b>
			<b>9 x 3</b>

③

