

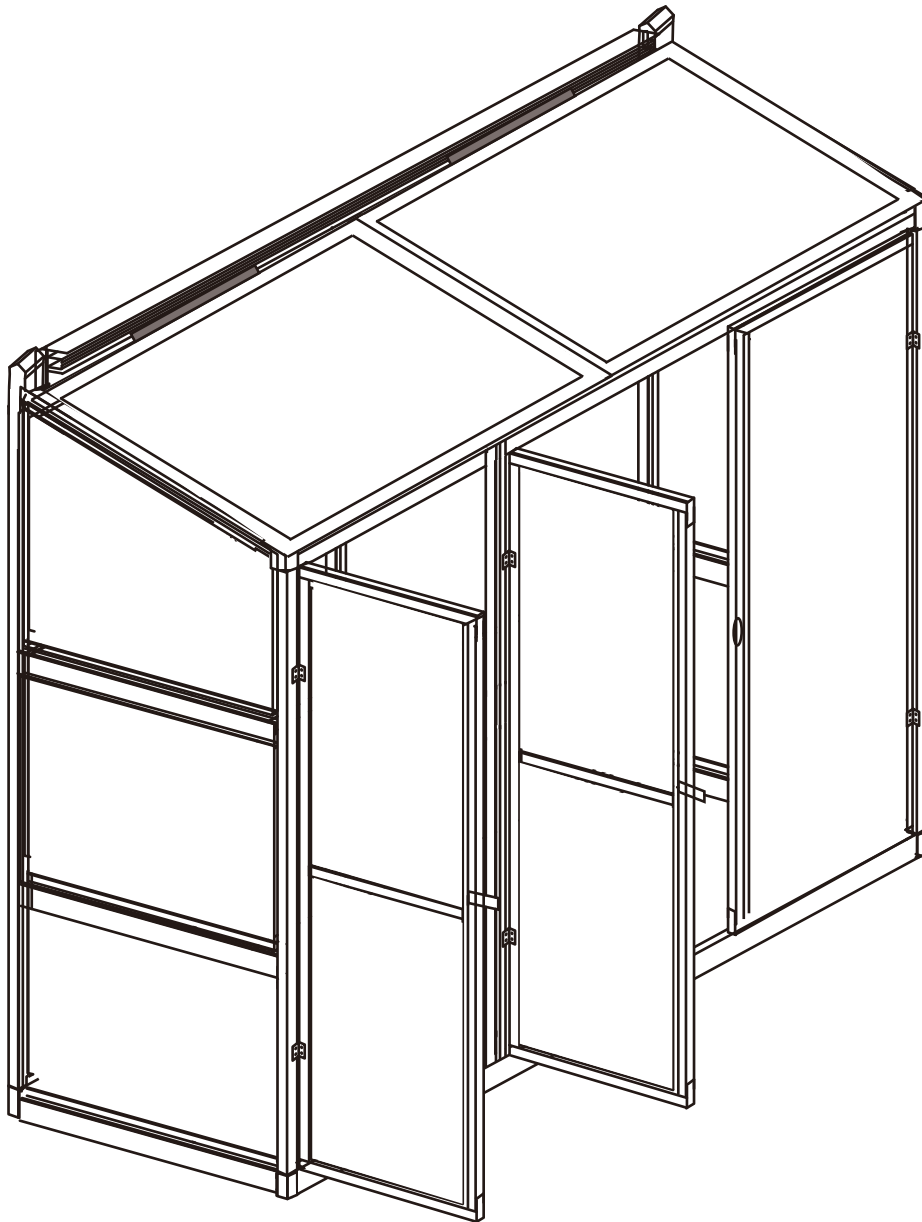

INbxa008\_GL

845-524



IMPORTANT, RETAIN FOR FUTURE REFERENCE: READ CAREFULLY

# ASSEMBLY & INSTRUCTION MANUAL

① x 1  
L176.8

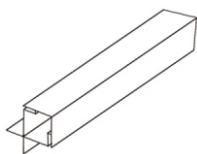

② x 1  
L176.8

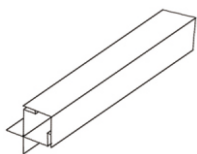

③ x 2  
L49.8

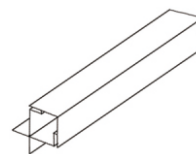

4A x 1  
L152.8

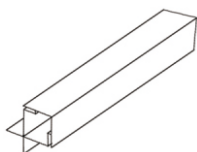

4B x 1  
L152.8

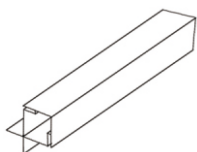

5A x 1  
L181.3

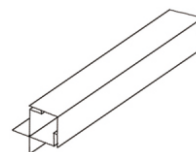

5B x 1  
L181.3

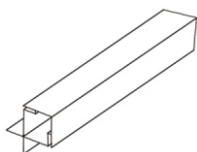

⑥ x 2  
L55

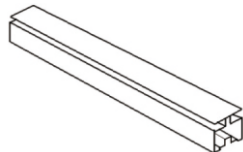

⑦ x 1  
L176.8



⑧ x 1  
L176.8

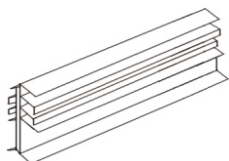

⑨ x 1  
L152.8

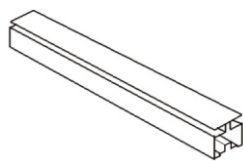

⑩ x 1  
L176.8

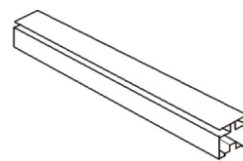

⑪ x 4  
L49.8

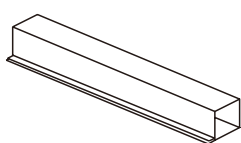

⑬ x 1  
L57

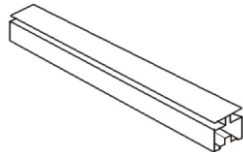

⑭ x 2  
L145.6

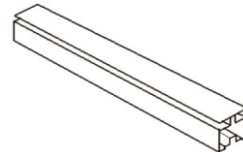

**15** x 2  
L145.6

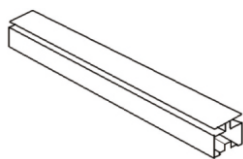

**16** x 1  
L145.6

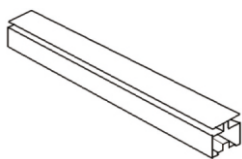

**17** x 1  
L145.6

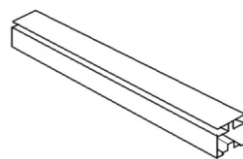

**18** x 6  
L61.3

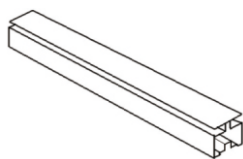

**19** x 3  
L61.3

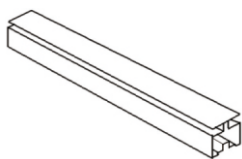

**32** x 4

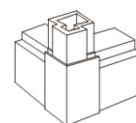

**33A** x 1

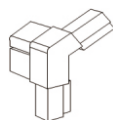

**33B** x 1

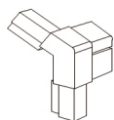

**34A** x 1



**34B** x 1

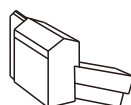

**B** x 4

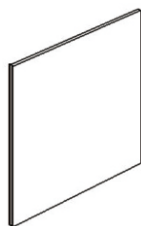

60.6\*51.2

**C** x 2

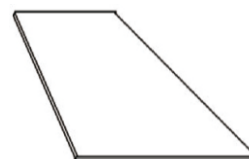

60.4\*51.2\*33.6

**D** x 6

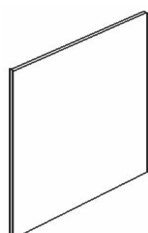

72.7\*51.7

**E** x 2

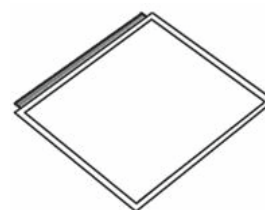

58.4\*90.5

**42** x 39  
M6\*12  
+2(spare)

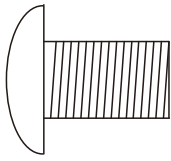

**43** x 2  
M4\*8

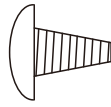

**44** x 2  
M6\*26

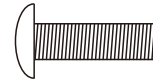

**47** x 2  
L 100

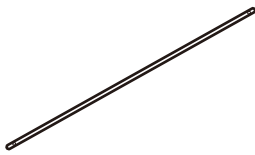

**42** x 8  
M6\*12

