

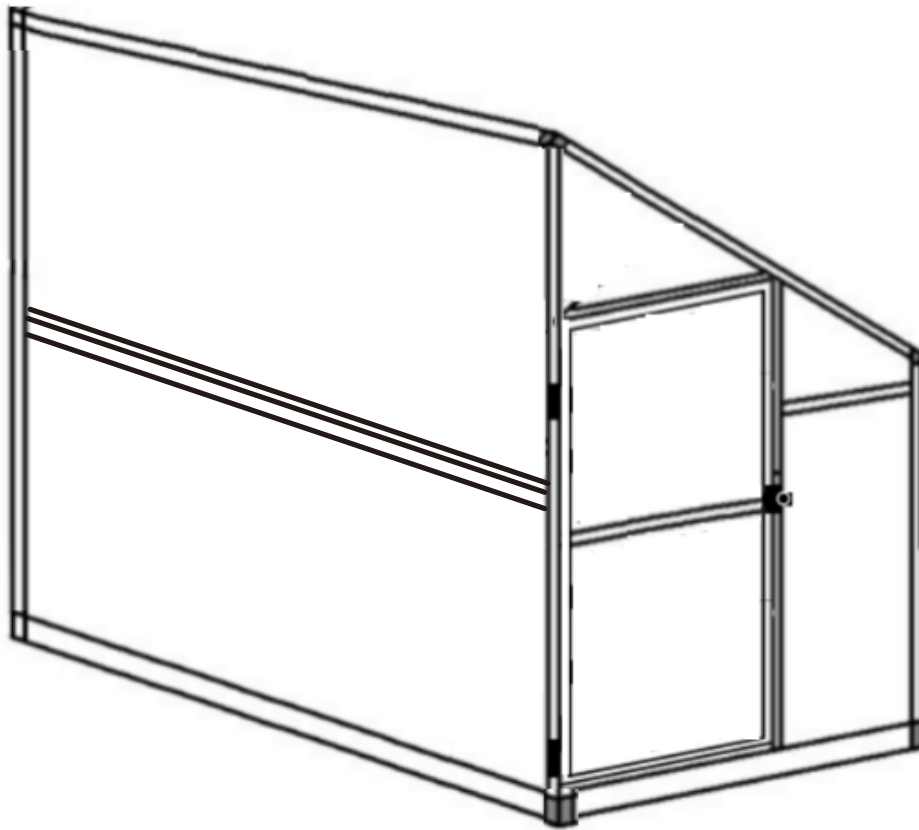

INbxa009\_GL

**845-525**



IMPORTANT, RETAIN FOR FUTURE REFERENCE: READ CAREFULLY

# ASSEMBLY & INSTRUCTION MANUAL

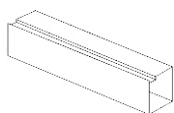

**①** x 1  
L176.2

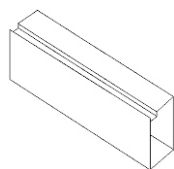

**②** x 1  
L176.2

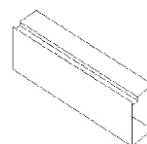

**③** x 1  
L116.8

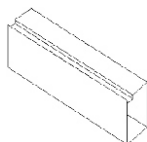

**④** x 1  
L116.8

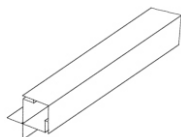

**5A** x 1  
L186

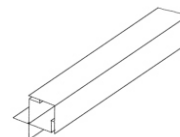

**5B** x 1  
L186

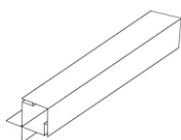

**6A** x 1  
L115

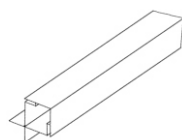

**6B** x 1  
L115

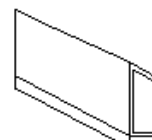

**⑦** x 1  
L176.2

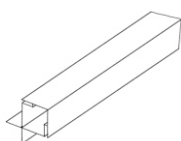

**8A** x 1  
L134

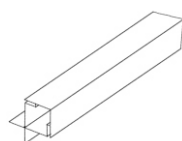

**8B** x 1  
L134

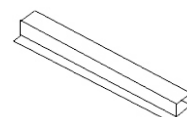

**⑨** x 1  
L149.7

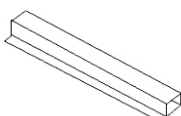

**⑩** x 1  
L152.7

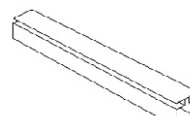

**⑪** x 2  
L115

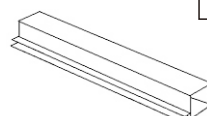

**⑫** x 2  
L136.2

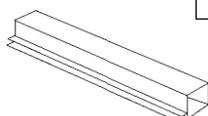

**⑬** x 1  
L140.2



**⑭** x 1  
L140.2

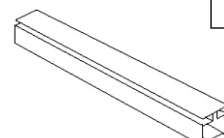

**⑮** x 2  
L55.7

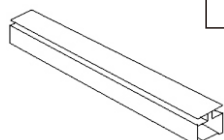

**⑯** x 1  
L55.7

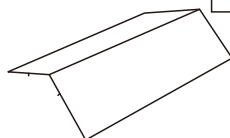

**⑰** x 1  
L176.2

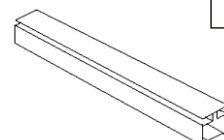

**⑱** x 1  
L63

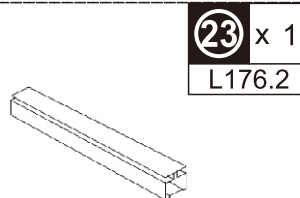
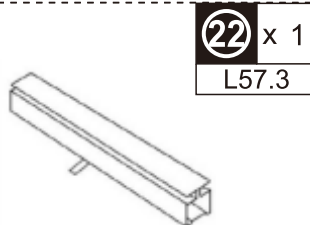
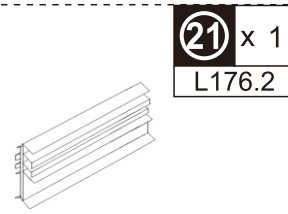
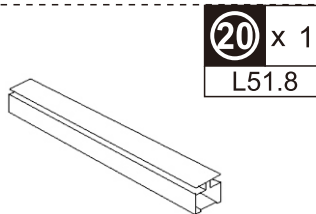
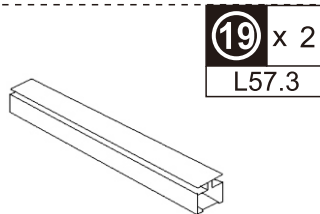

58.6\*117.5



58.6\*137.5



58.5\*11\*4.4

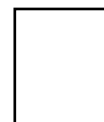

53.1\*11\*4.4

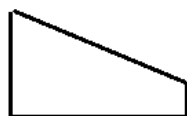

58.2\*72\*38.8

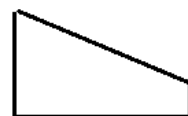

58.5\*38.8\*3.5

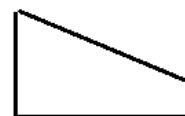

63.5\*37.5\*1.5

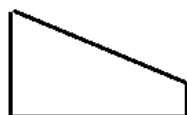

53.1\*34.5\*3.5



58.6\*75.5

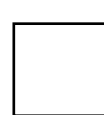

58\*58

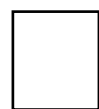

70\*57.2

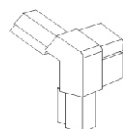
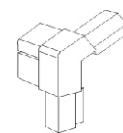
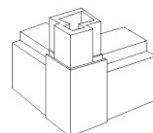

42 x 45  
M6\*12  
+2(spare)

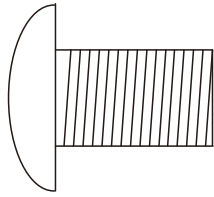

43 x 2  
M4\*8

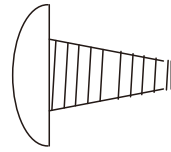

44 x 2  
M6\*26

