

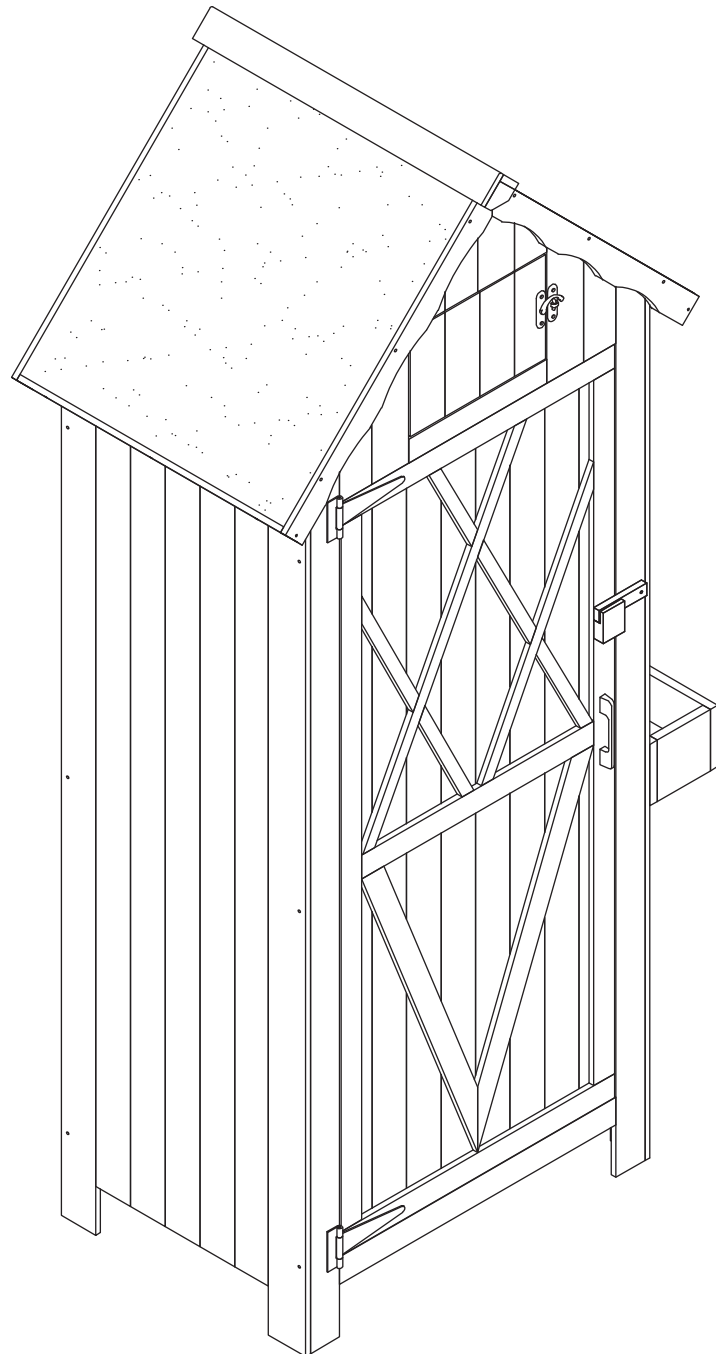







INbya020_GL

845-707

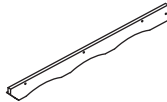

READ AND SAVE THIS INSTRUCTIONS FOR FUTURE USE

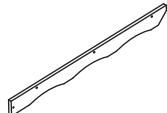
ASSEMBLY & INSTRUCTION MANUAL

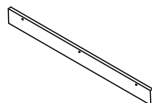
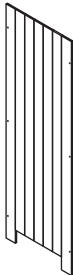
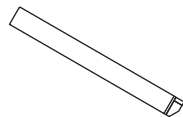
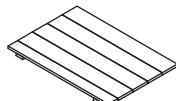
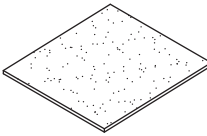
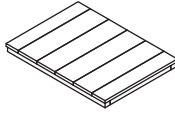
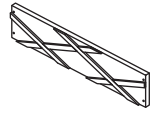
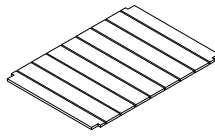
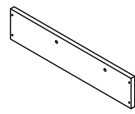
	① x1		⑧ x2
	② x1		⑨ x2
	③ x1		⑩ x2
	④ x1		⑪ x1
	⑤ x2		⑫ x2
	⑥ x3		⑬ x1
	⑦ x1		⑭ x0

15 x1

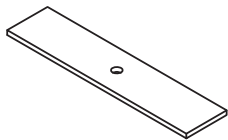

F x02(spare)

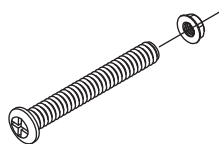

M6*60

16 x2



A x07+1(spare)

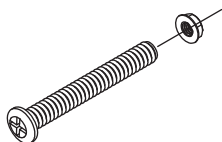

M6*45

B x08+1(spare)

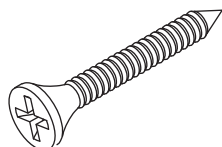

M3.5*35

C x30+2(spare)

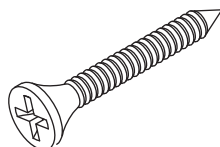

M3*30

D x12+1(spare)

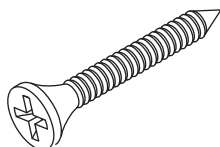

M3.5*25

E x1(spare)

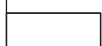
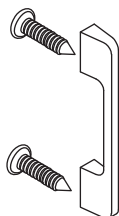

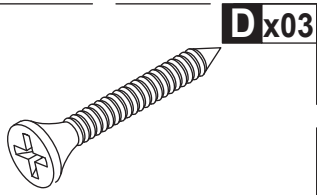

Dx03

M3.5*25



2x01

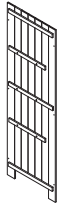

3x01

3

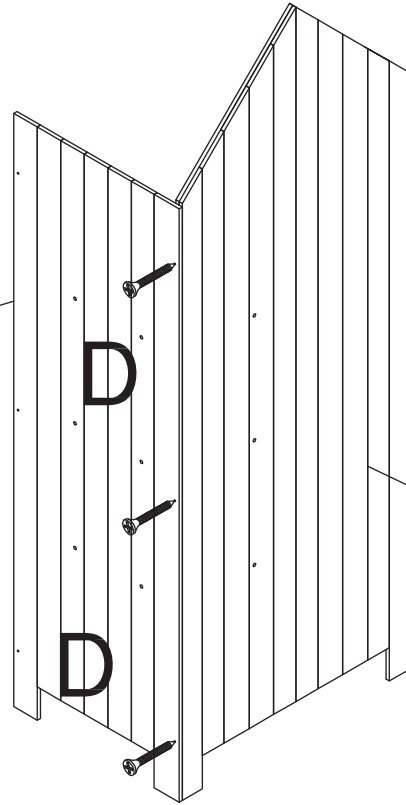

2

D

D

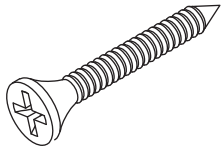

Cx04

M3*30

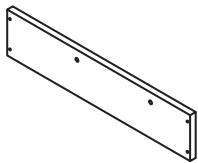

14x01

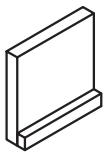

16x02

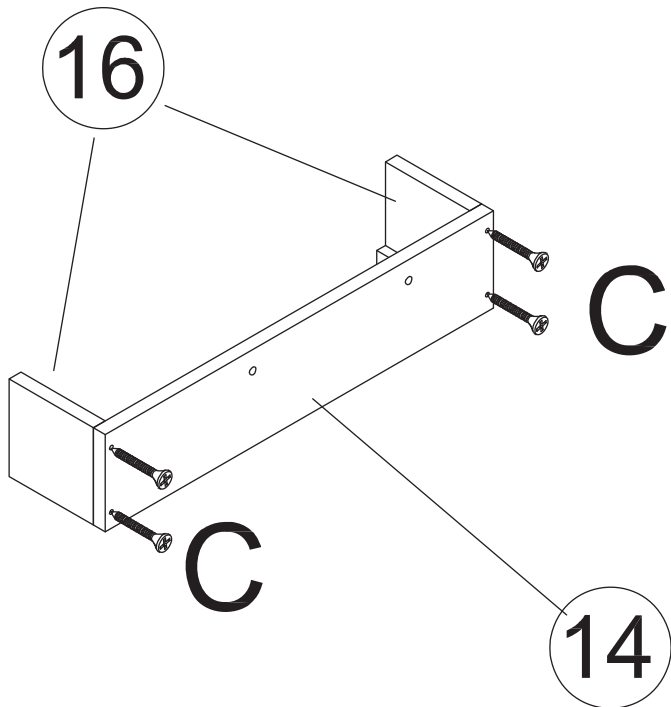

16

C

C

14

Ax04

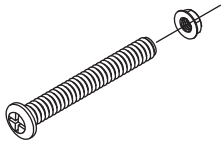

M6*45

Fx02

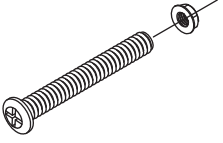

M6*60

6x03

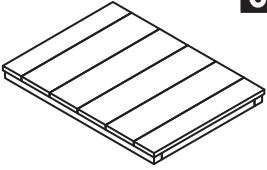

6

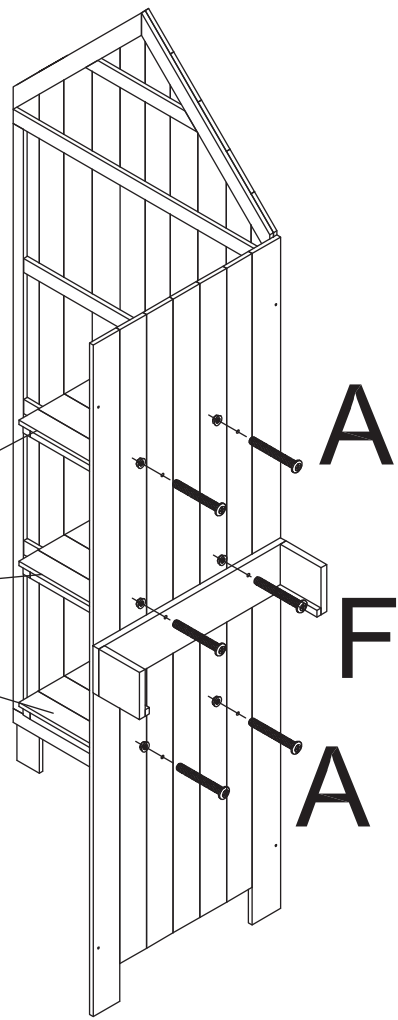

Ax03

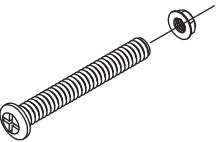

M6*45

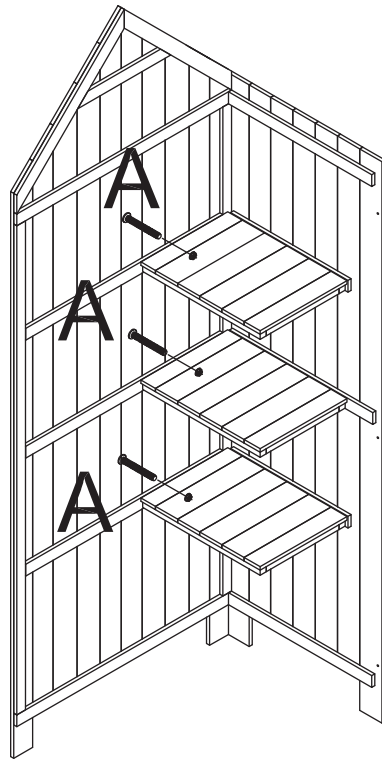

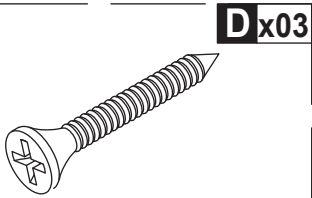

Dx03

M3.5*25



1x01

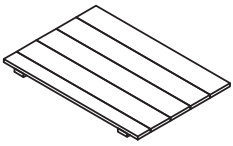

5x02

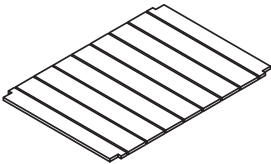

7x01

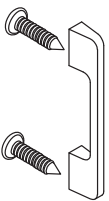
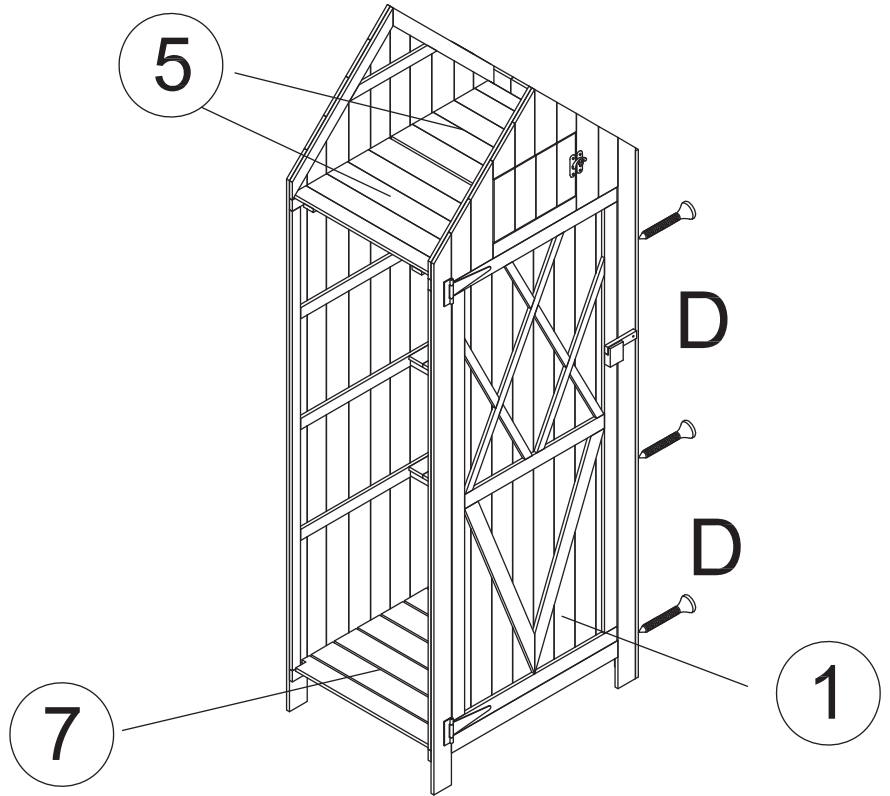

Ex01

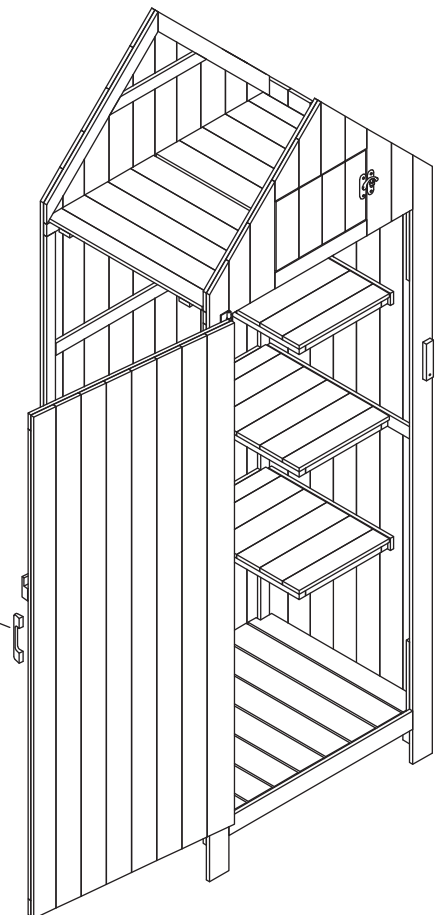
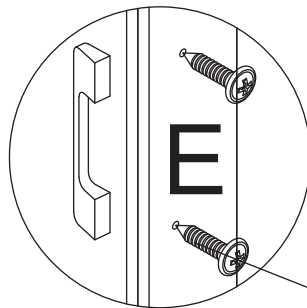

Dx06

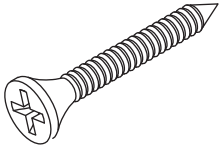

M3.5*25

4 x01

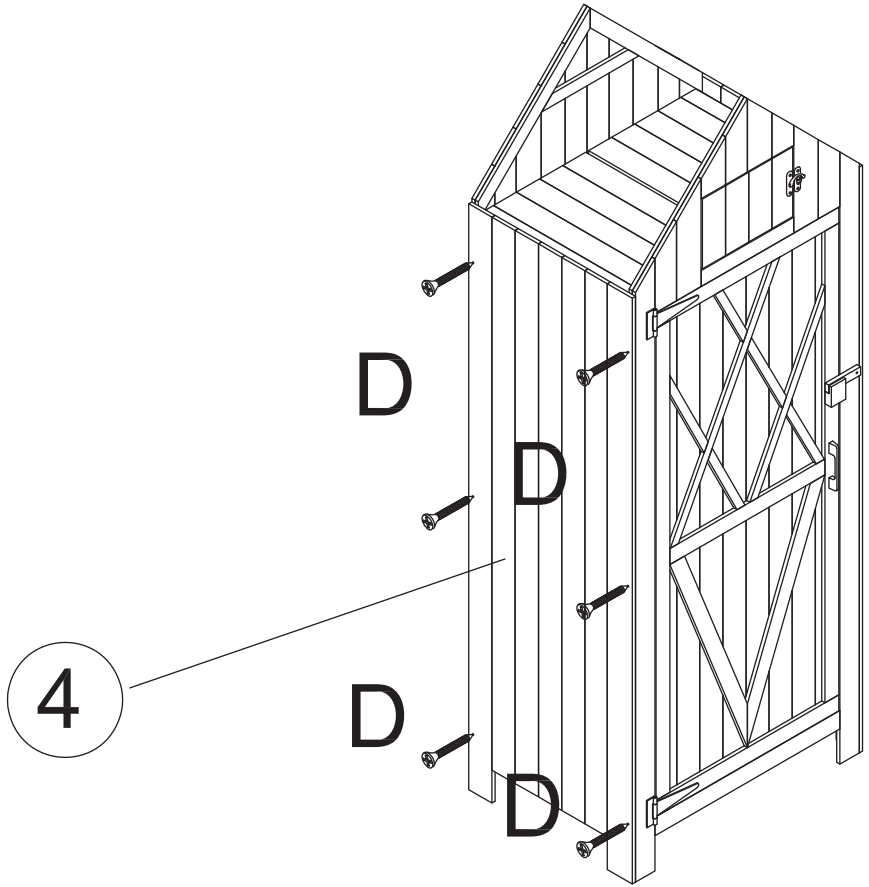
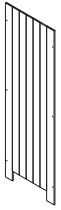

Cx22

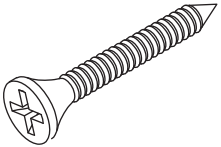

M3*30

12x02

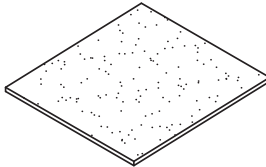

8 x02

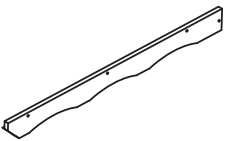

9 x02

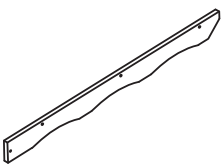

10x02

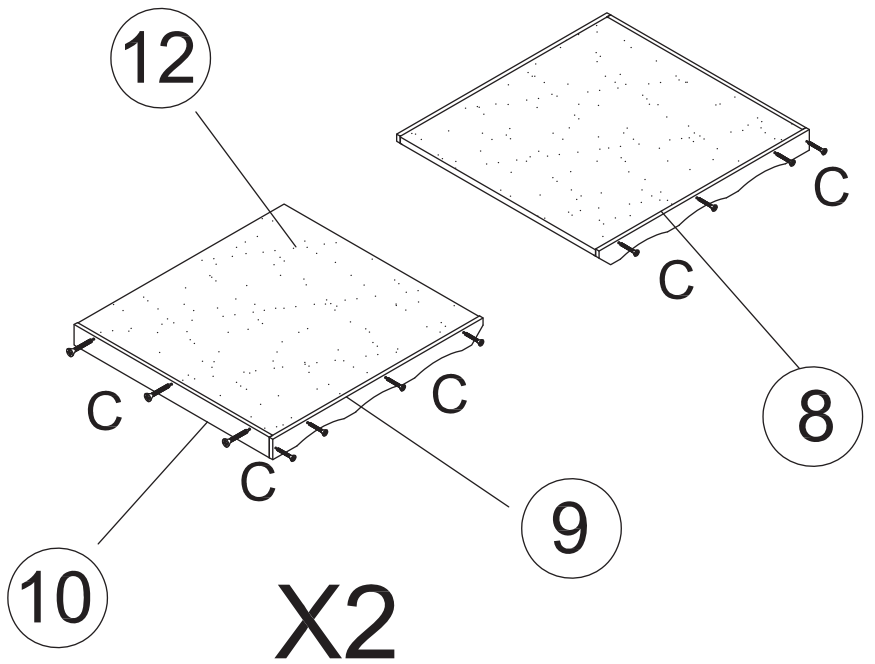
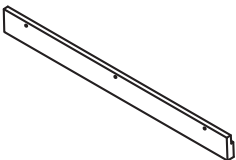

Bx02

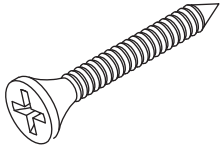

M3.5*35

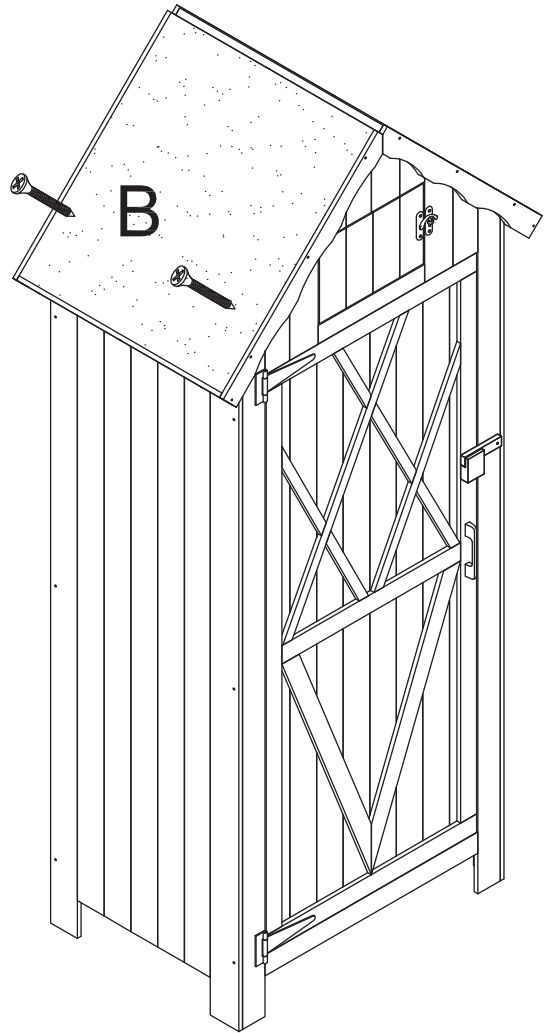

Bx02

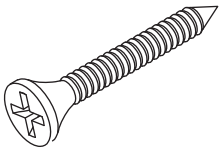

M3.5*35

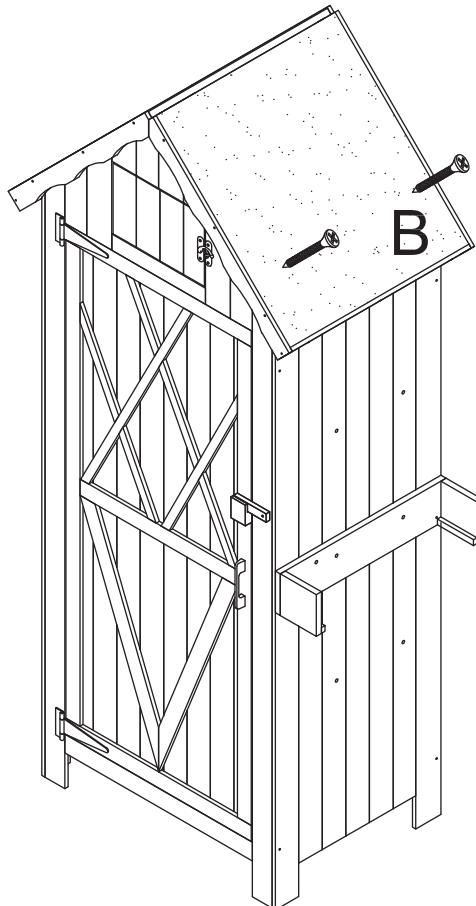

Bx02

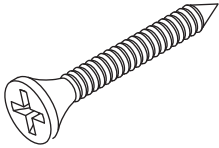

M3.5*35

11x01

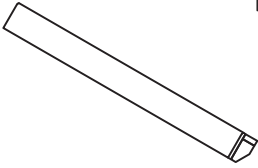

11

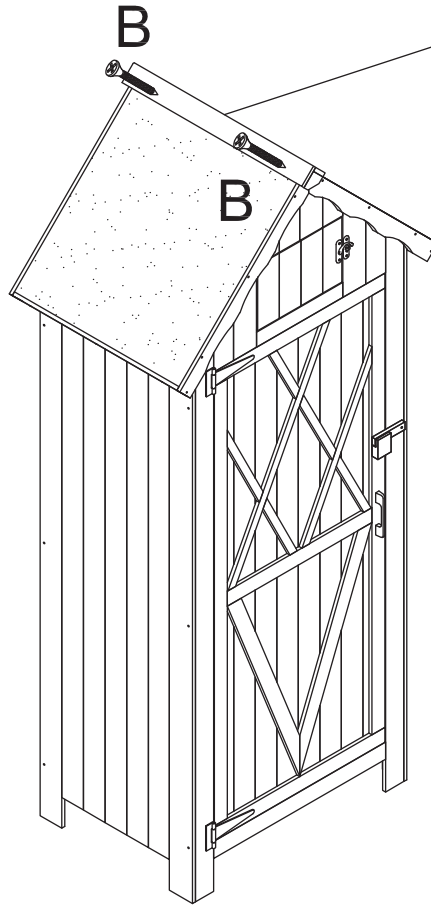

Bx02

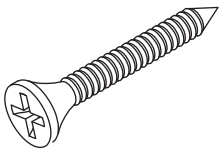

M3.5*35

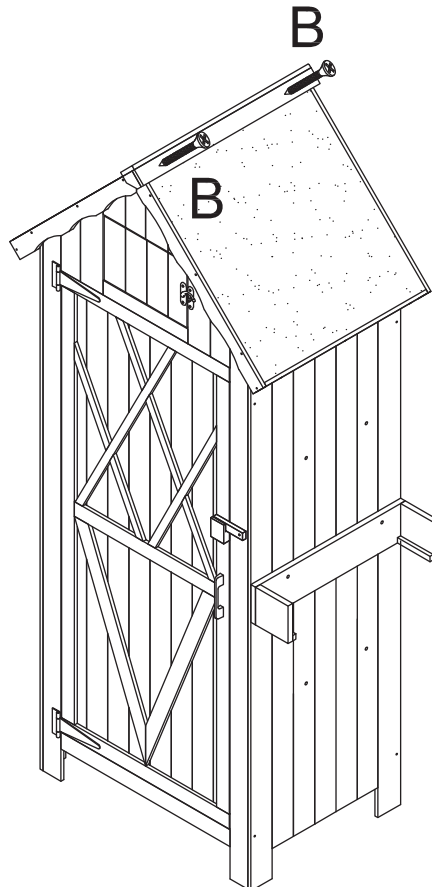

Cx04

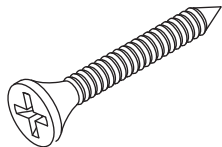

M3*30

13x01

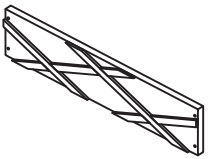

15x01

