

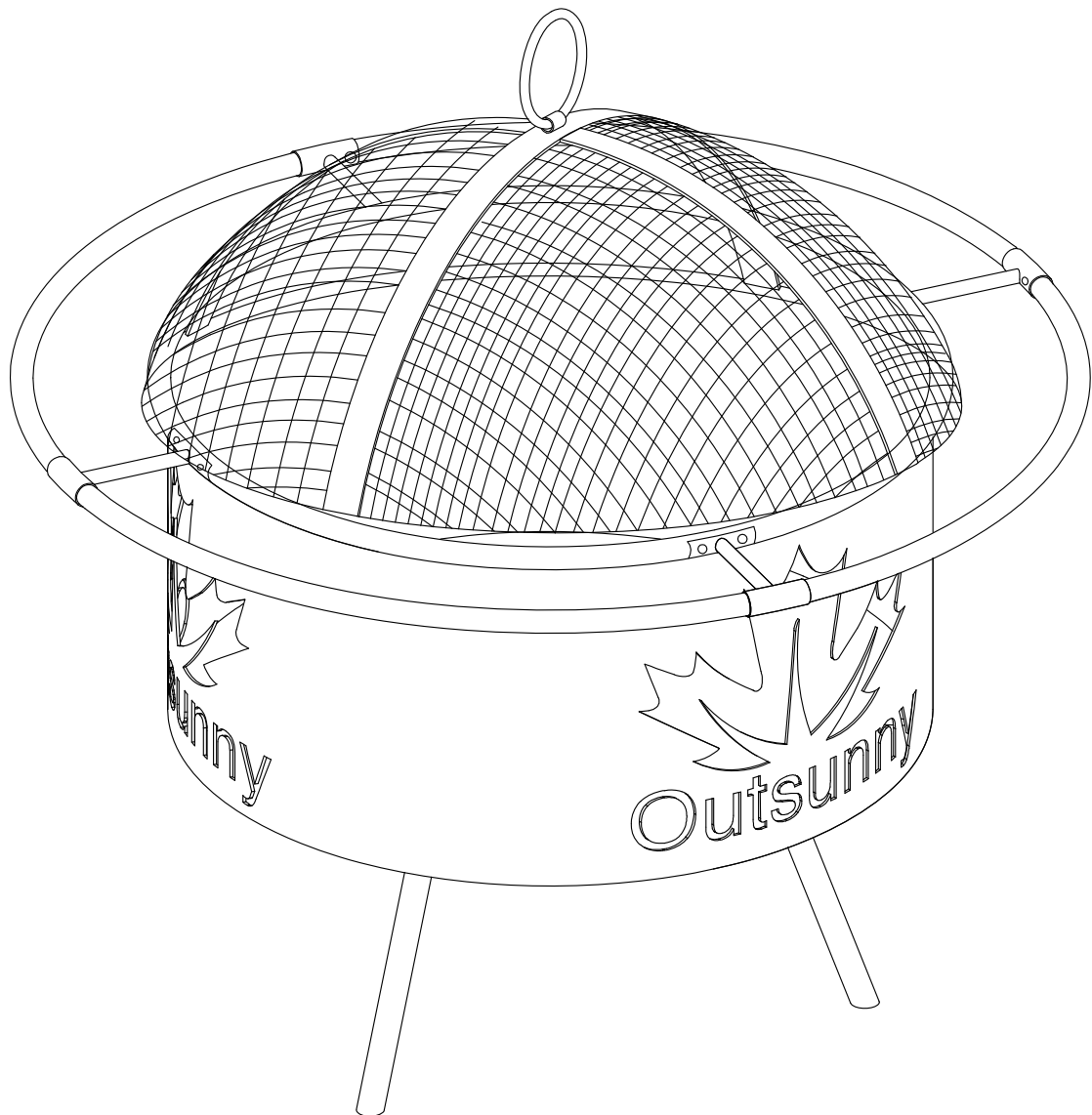

INbzb030_GL

842-255



IMPORTANT, RETAIN FOR FUTURE REFERENCE: READ CAREFULLY

ASSEMBLY & INSTRUCTION MANUAL

PARTS

A x 4

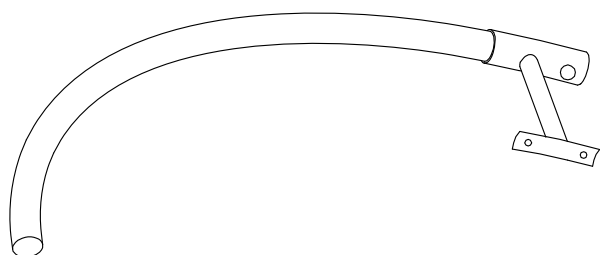

B x 1

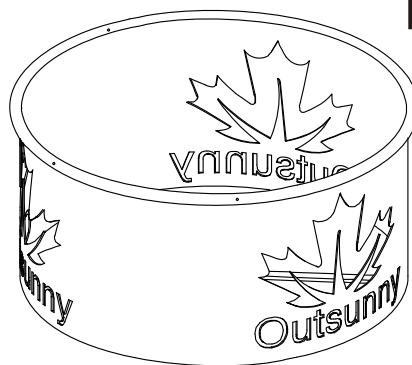

C x 3

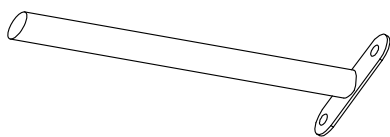

D x 1

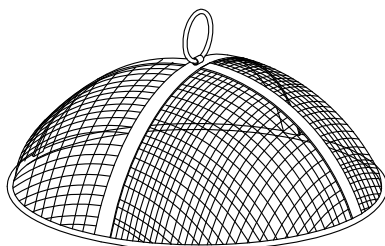

E x 1

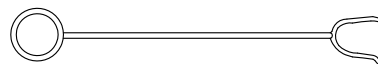

F x 6
+1(spare)

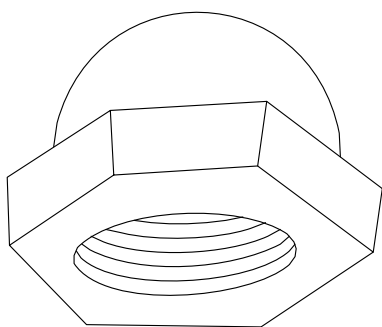

G x 12
+1(spare)

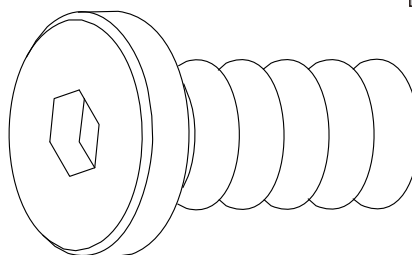

H x 1



I x 1

