

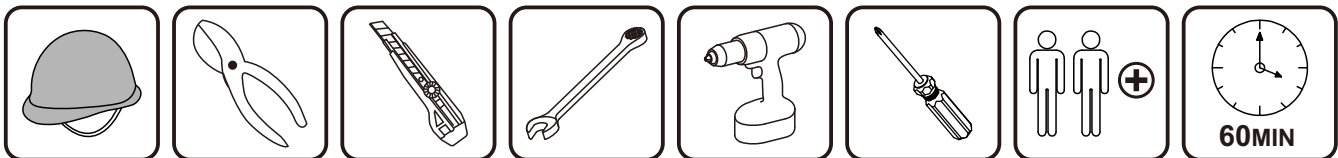

INbzb034V01_GL

842-226_842-242

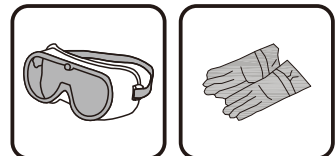
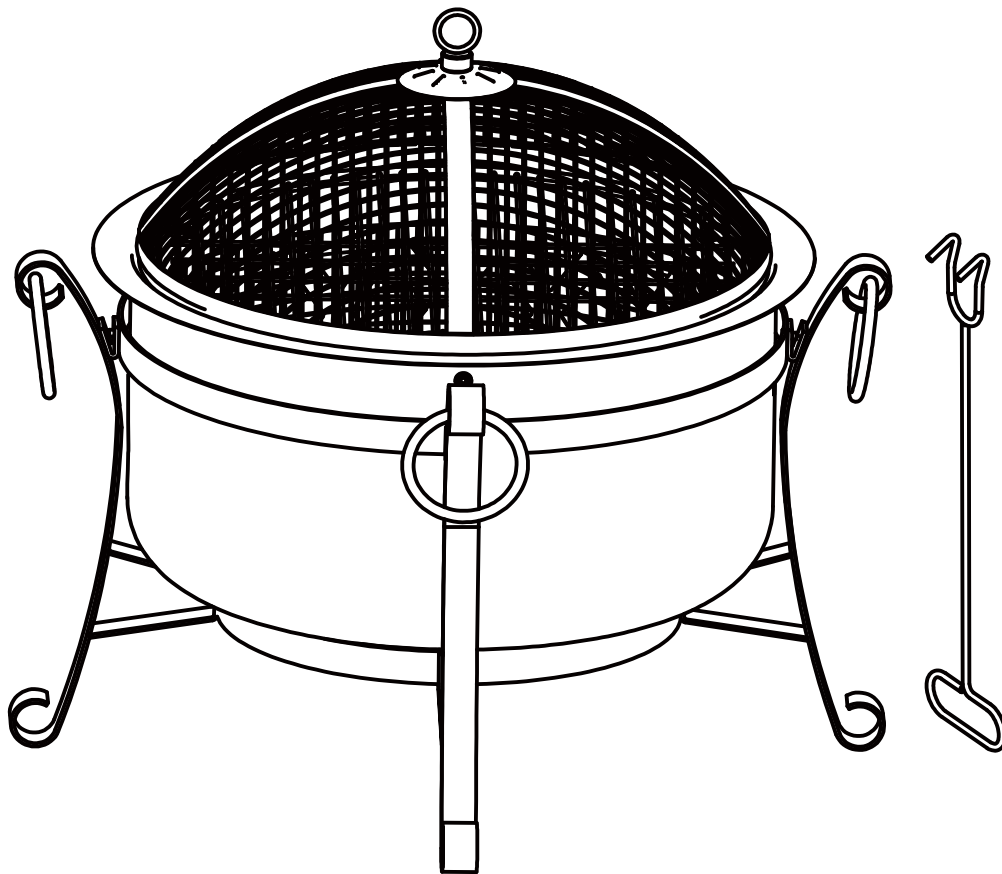

IMPORTANT, RETAIN FOR FUTURE REFERENCE: READ CAREFULLY

Tools Recommended

ASSEMBLY & INSTRUCTION MANUAL

PARTS

1 x 1

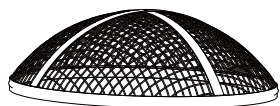

2 x 1

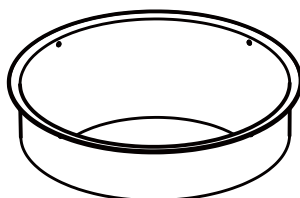

3 x 1

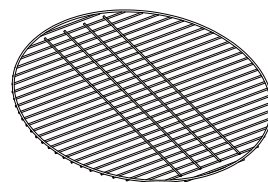

4 x 4

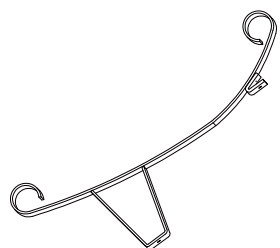

5 x 4

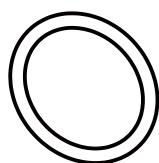

6 x 1

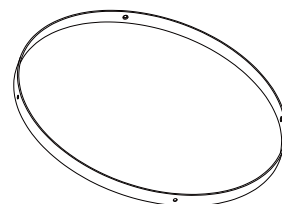

7 x 1

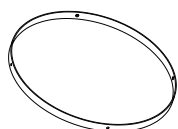

8 x 1



9 x 1

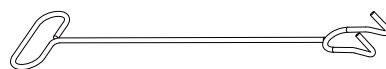

HARDWARE

10 x 1

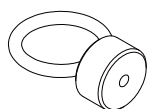

11 x 1

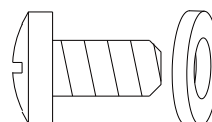

12 x 8

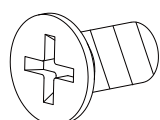

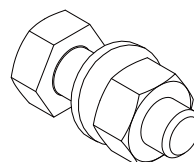

+1(spare)

13 x 3



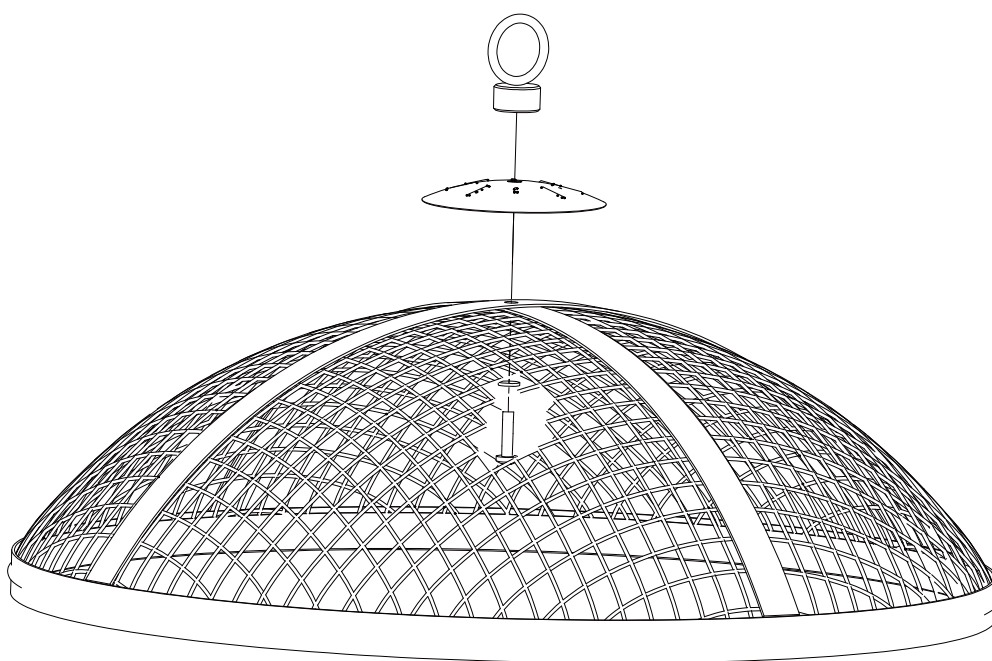

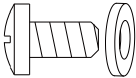
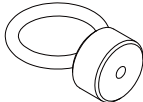
+1(spare)

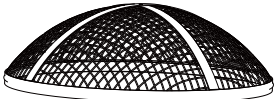

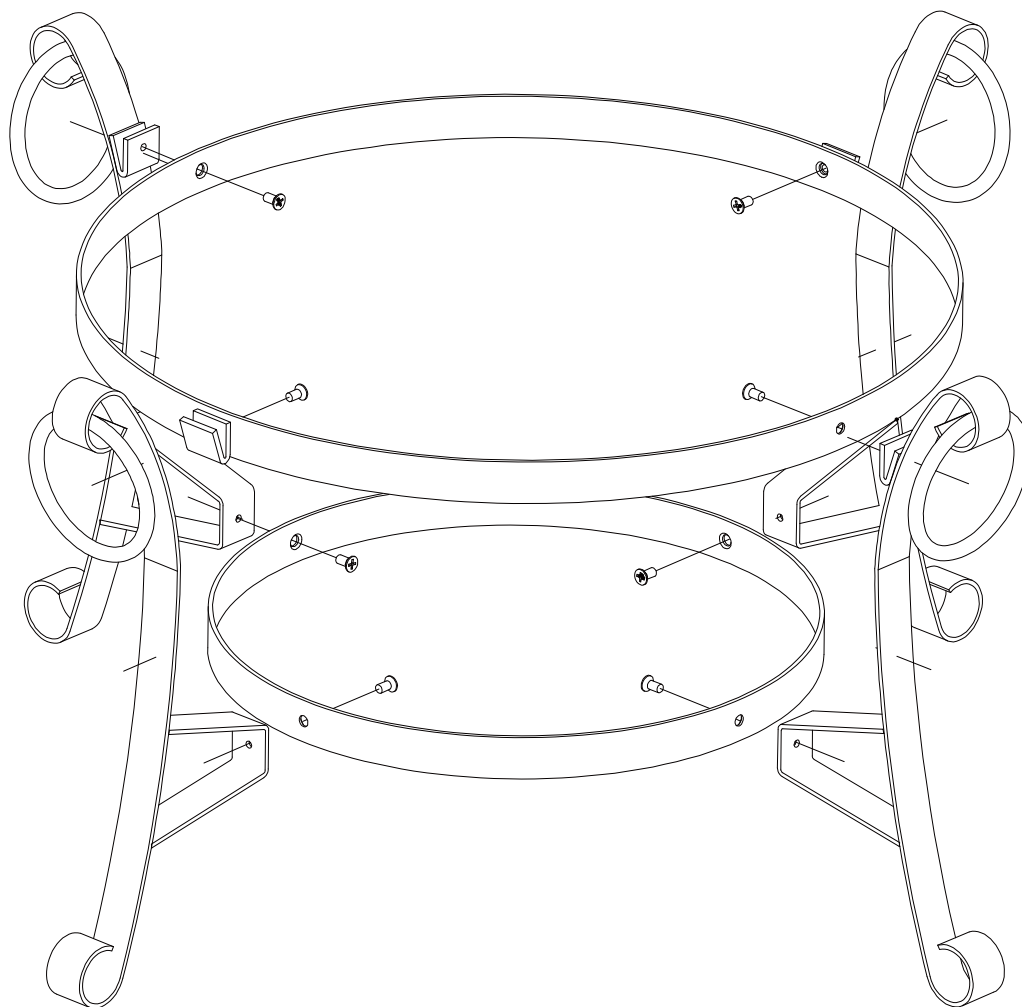

	1
	1
	1
	1

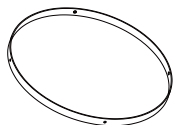
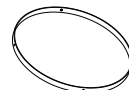

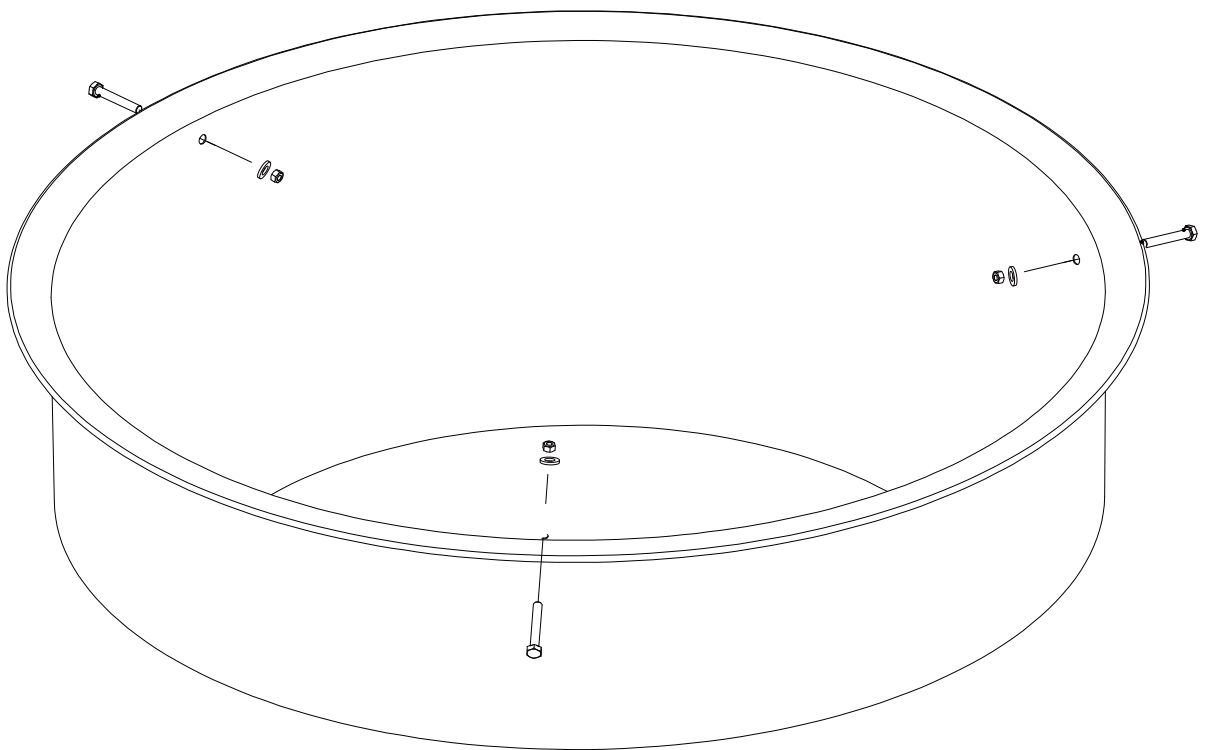

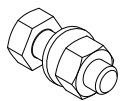
	8
	4
	4
	1
	1

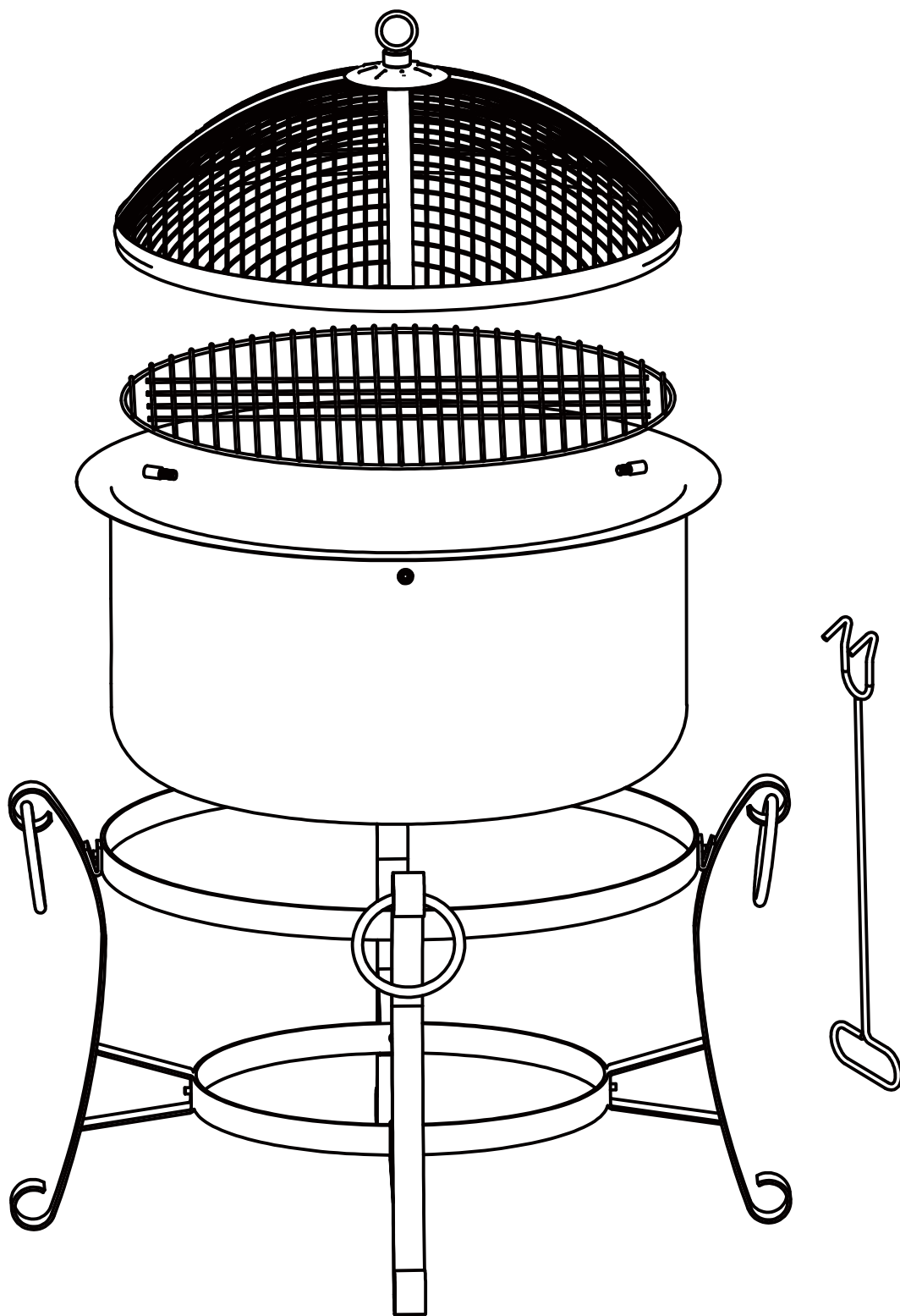

	3
	1



	1
	1