

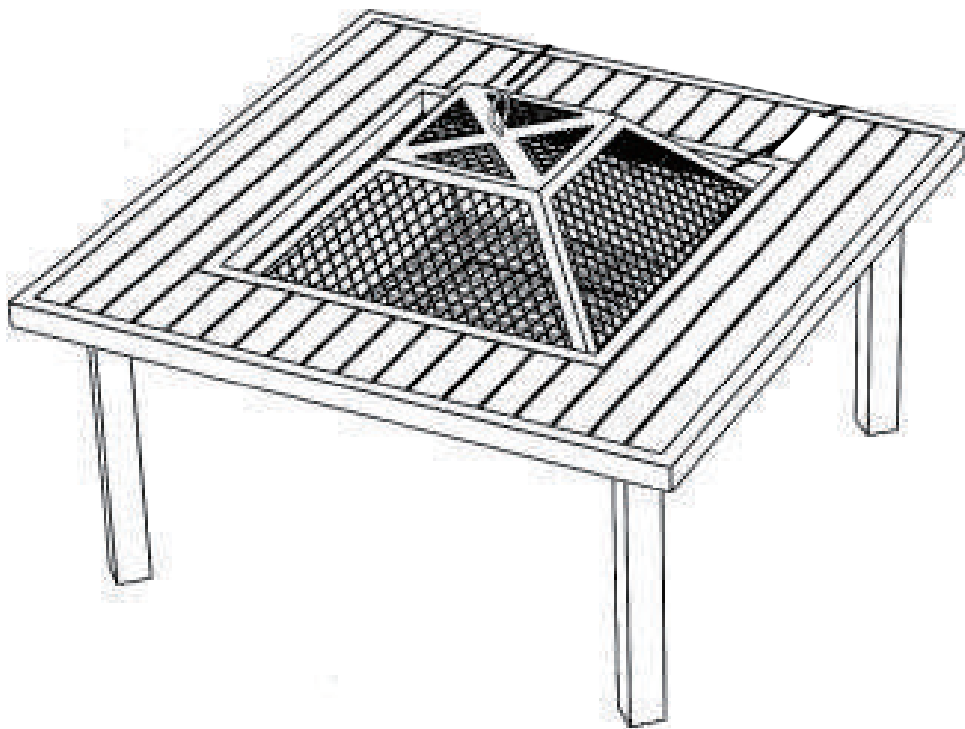

INbzb045_US









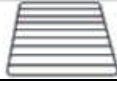
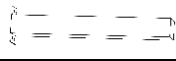

842-270V01



IMPORTANT, RETAIN FOR FUTURE REFERENCE: READ CAREFULLY

ASSEMBLY & INSTRUCTION MANUAL

Part List

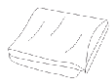
Part List	Description	Qty.	Drawings
A	Table Top	1	
B	Iron Grate	1	
C	Leg	1	
D	BBQ Grill	1	
E	Mesh Lid	1	
F	Fire Bowl	1	
G	Bolt	8	
H	Nut	1	
I	Lid Ring	1	
J	Allen Wrench	1	
K	Poker	1	
L	Table Lid	1	
M	Protective Cover	1	

Tool required: Allen Wrench (provided)

Special Warnings

- Check local bylaws before using the fire pit.
- This fire pit is intended for Outdoor Use Only! DO NOT use on wooden decks.
- This fire pit is intended to Burn Wood Logs Only! DO NOT burn coal, leaves or other combustible materials in the fire pit.
- NOT for use by children. Keep children and pets away from the fire pit.
- Fire pit is hot, use with caution. NEVER touch hot fire pit with bare hands.
- NEVER leave burning fire pit unattended and always extinguish fire completely before leaving the fire pit.
- Maintain a minimum of 5 FT from any structure!
- DO NOT use near flammable or combustible objects or materials.
- Only CHROMED PLATED COOKING GRID(Not provided) is intended for cooking.LOG GRATE is NOT intended for cooking and SHOULD NOT be used for this purpose.

Operation Instructions

- Place logs on grate and light with match. DO NOT overload logs.
- Please use Poker (provided) when handling.
- We do not recommend pouring water over the fire unless necessary. The fire should be allowed to expire on its own.

Care and Maintenance

This fire pit is a quality-built product and is made to last for many years.

The frame structure of this unit is made of powder-coated steel extrusion and should resist rusting under normal use. Should rusting occur, we suggest using a steel brush on the affected area followed by a spray coating of high temperature anti-rust paint.

For additional rust proofing of the bowl, grate and mesh lid we recommend that a coat of high temperature primer (such as rustoleum or similar brand) is applied **before** use.

You may cover the fire pit with a Protective Cover (provided) when the fire pit is not in use. Ensure the fire pit has completely cooled down before using the Protective Cover.

Assembly Instructions

Estimated Assembly Time: 10 Minutes

DO NOT over tighten hardware!

Step 1: Place parts on a smooth even surface, Fix Legs(C) to Table Top (A) by using Bolt (G). Tighten all hardware accordingly with an Allen Wrench (J) (provided) and make sure all pieces fit together securely. (View Fig.1)

Fig.1

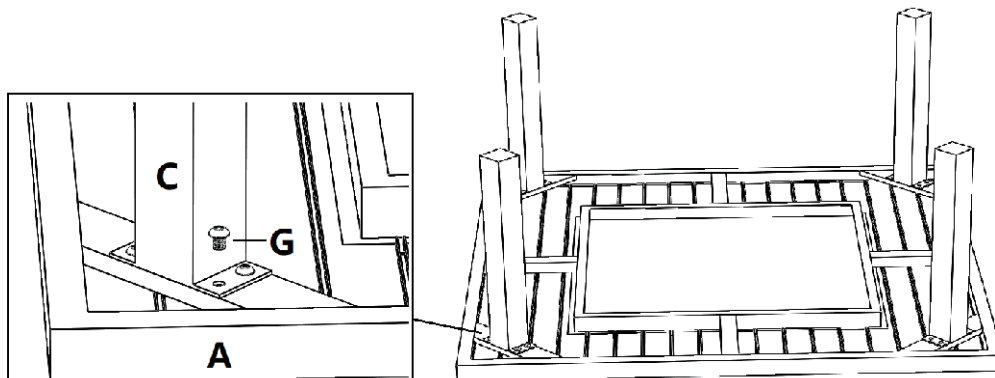

Step 2: Turn the assembled fire pit frame over so that it sits securely (legs down) on a flat surface. Place Fire Bowl (F) in the center of Table Top (A) and put Iron Grate (B) in the Fire Bowl (F). Mount Lid Ring (I) on the Mesh Lid (E) by using Nut (H), then place the assembled Mesh Lid over the Fire bowl (F). (View Fig.2).

Fig.2

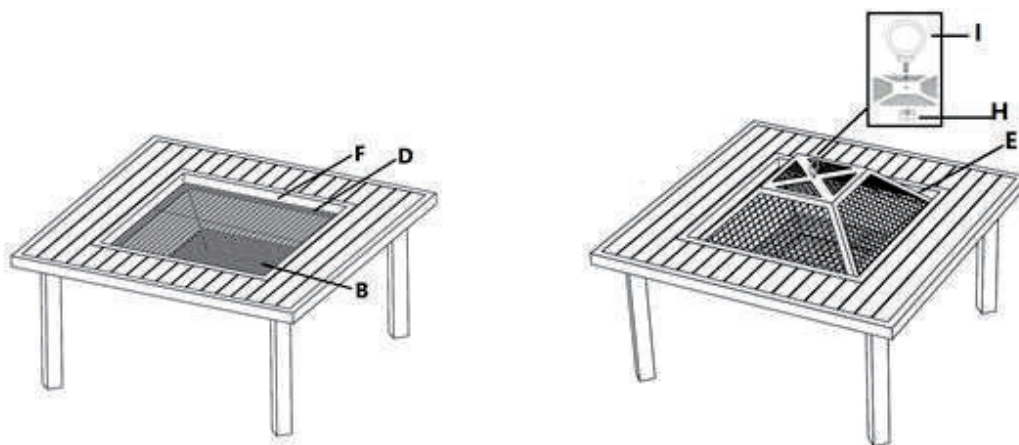

Your **FIRE PIT** is ready for use!

Step 3: Table: Take away the Mesh Lid (E) and put Table Lid (L) onto the Fire Bowl (F) (View Fig.3)

Fig.3

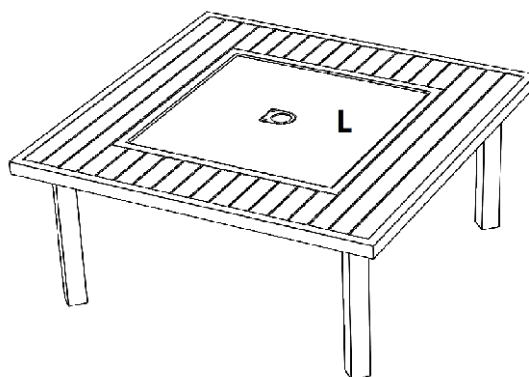

Your **Table** is ready for use!

Step 4: Cover the fire pit with a Protective Cover (M) when the fire pit is not in use. Ensure the fire pit has completely cooled down before using the Protective Cover. (View Fig.4)

Fig.4

