

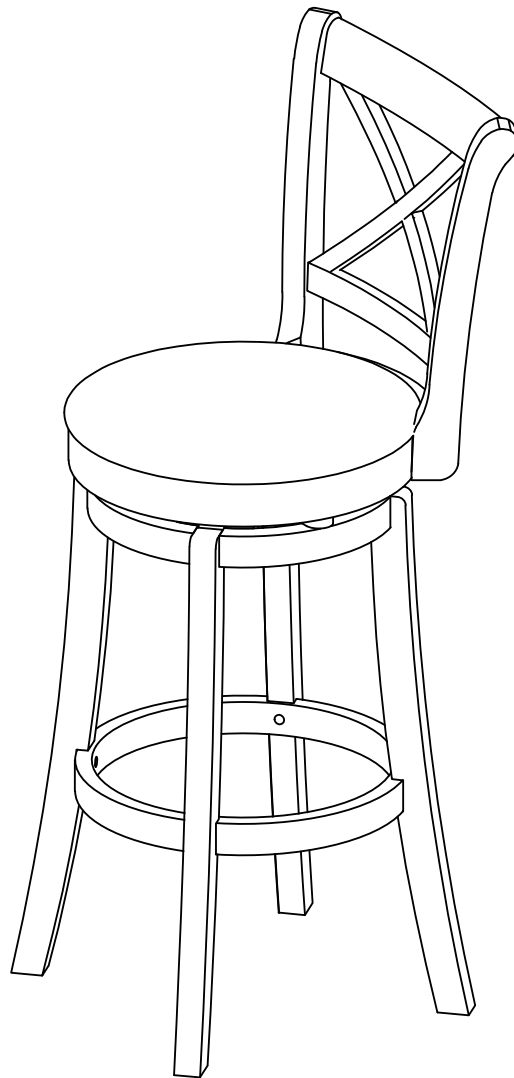

INc4b075_US

835-422

Ver 032021.08



ASSEMBLY INSTRUCTIONS

SAFETY INFORMATION

⚠️ Warranty Coverage Requirements:

1. Pictures of the damaged parts.
 - . You must know the name or MOLDE number of your product.
3. Please gather all of this information **BEFORE** you contact customer service.

⚠️ WARNING

1. Please read and understand this entire manual before attempting to **assemble or install the product.**
2. **Assemble the item on a soft, non-abrasive surface such as carpeting to avoid damage.**
3. Item is heavy. Handle with care. May require two adults for safe assembly.
Estimated Assembly Time: 60 minutes

⚠️ CAUTION

Recommended maximum sitting weight for the stool is 350 lbs/ 160kgs.

⚠️ PREPARATION

Before beginning assembly of product, make sure all parts are present. Compare parts with parts list. If any part is missing or damaged, do not attempt to assemble the product and contact us immediately

PACKAGE CONTENTS

PART	DESCRIPTION	QUANTITY
A	Chair back	01
B	Seat cushion	01
C	Seat frame	01
D	Chair legs	04
E	Foot rest	01

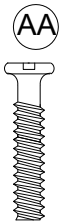
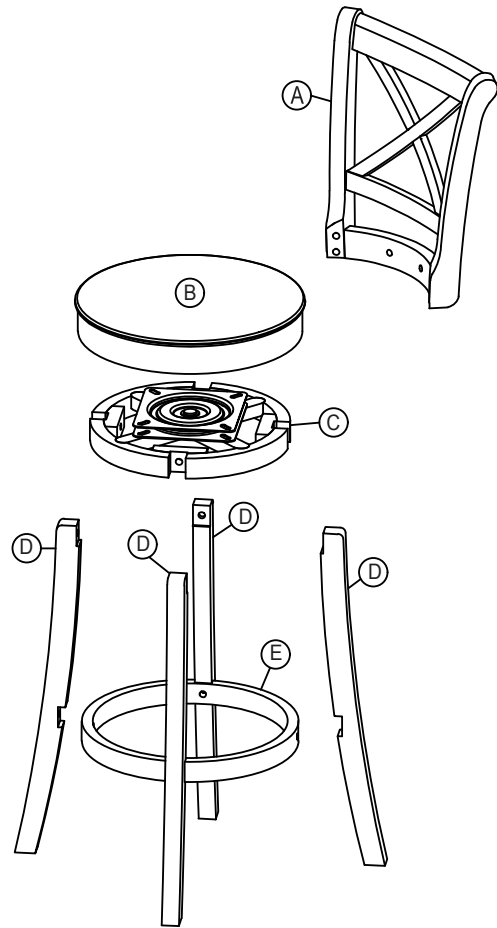

Ø6.3 x 25L
Bolt
Qty. 4

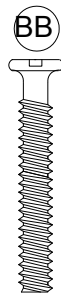

Ø6.3 x 45L
Bolt
Qty. 10
Extra. 1

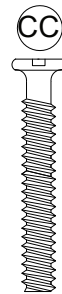

Ø6.3 x 50L
Bolt
Qty. 4
Extra. 1



Ø6.3
Spring
Washer
Qty. 18

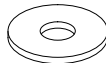

Ø6.3
Flat
Washer
Qty. 18

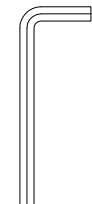

Allen
Wrench
Qty. 1

Ruler - Use this ruler to help correctly identify the screws.

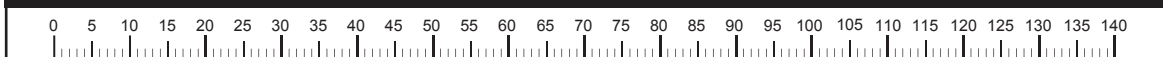





ASSEMBLY INSTRUCTIONS

FRAME ASSEMBLY

- Align six holes of the seat cushion (B). Insert $\text{\O}6.3 \times 45\text{L}$ bolt (BB), $\text{\O}6.3 \times 50\text{L}$ (CC) bolt through spring washer (DD), flat washer (EE), with the chair back (A). Repeat this procedure for adjacent hole.

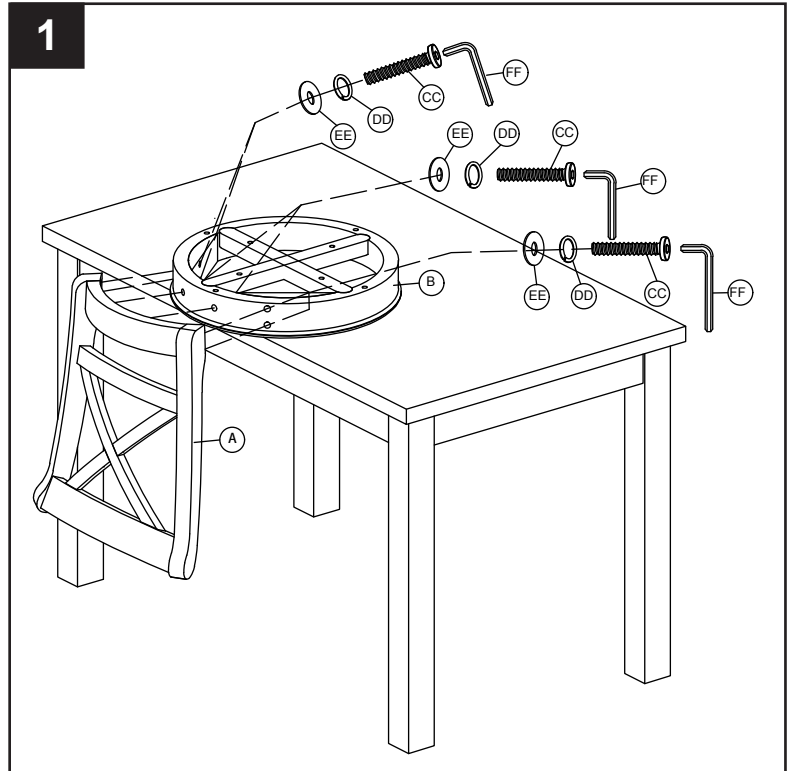

Hardware Used

ⓑ	$\text{\O}6.3 \times 45\text{L}$ Bolt		x 2
ⓒ	$\text{\O}6.3 \times 50\text{L}$ Bolt		x 4
ⓓ	$\text{\O}6.3$ Spring washer		x 6
ⓔ	$\text{\O}6.3$ Flat washer		x 6



- Align holes of the seat frame (C) and foot rest (E). Insert $\text{\O}6.3 \times 45\text{L}$ bolt (BB) through spring washer (DD), flat washer (EE), with the chair leg (D). Repeat this procedure for 2nd leg.

Hardware Used

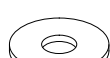
ⓑ	$\text{\O}6.3 \times 45\text{L}$ Bolt		x 4
ⓓ	$\text{\O}6.3$ Spring washer		x 4
ⓔ	$\text{\O}6.3$ Flat washer		x 4

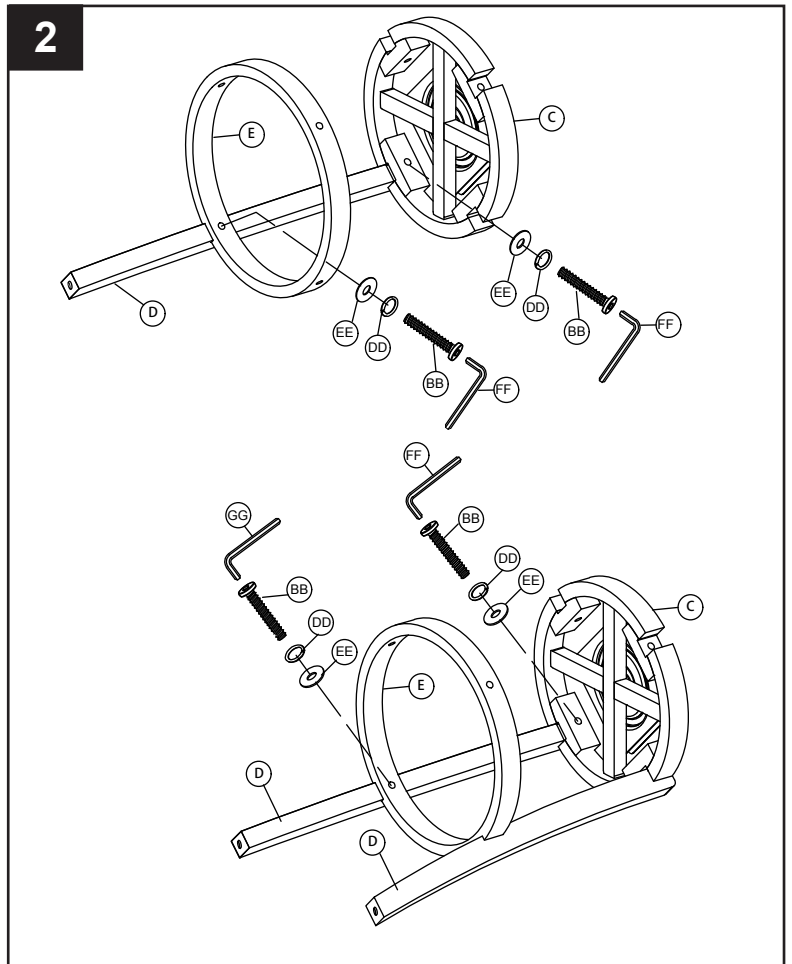



ASSEMBLY INSTRUCTIONS

FRAME ASSEMBLY

3. Repeat the same procedure as step 2 for the 3rd and 4th leg

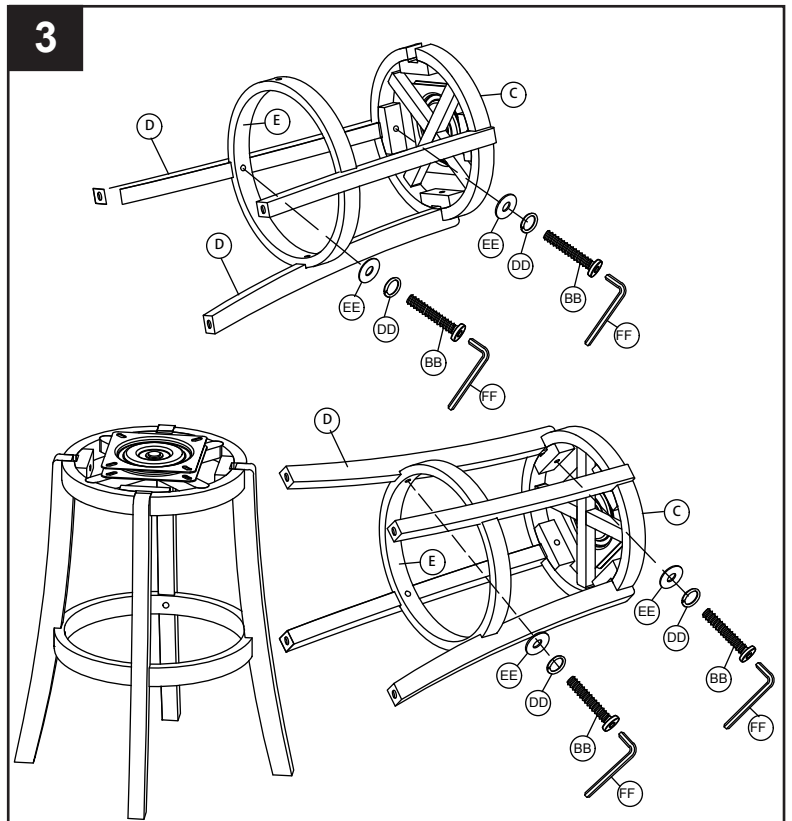

Hardware Used

BB	Ø6.3 x 45L Bolt		x 4
DD	Ø6.3 Spring washer		x 4
EE	Ø6.3 Flat washer		x 4



4. Align holes of the swivel plate (C). Insert Ø6.3 x 25L bolt (AA) through spring washer (EE), flat washer (FF), with the seat cushion (B). Repeat this procedure for adjacent hole. The assembly of this product has been completed.



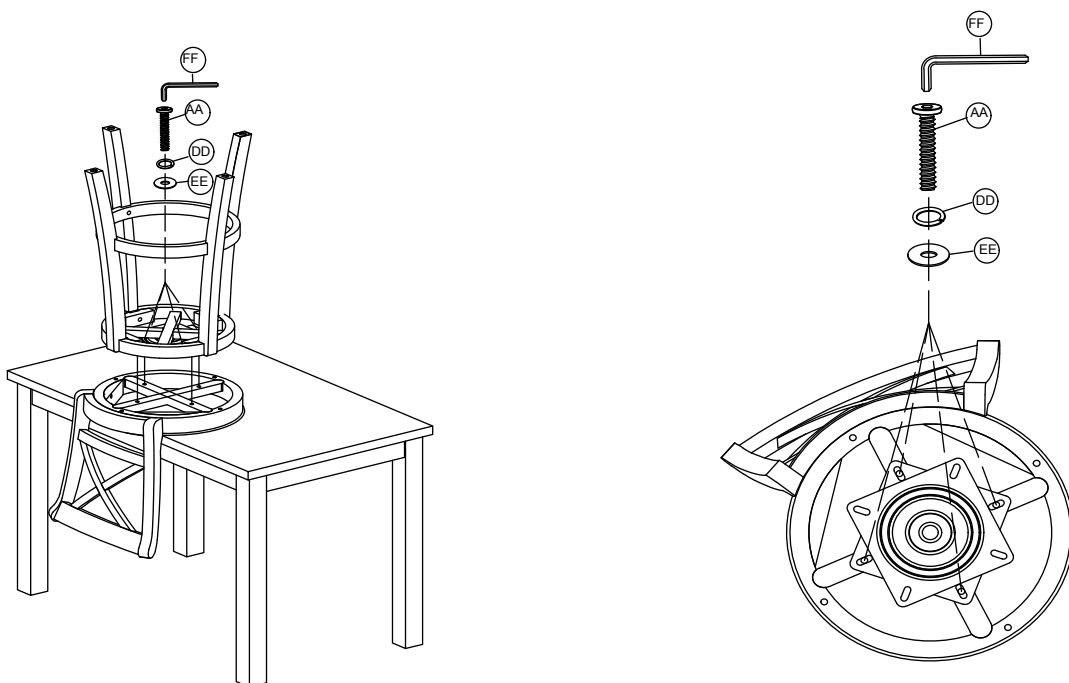

Hardware Used

AA	Ø6.3 x 25L Bolt		x 4
DD	Ø6.3 Spring washer		x 4
EE	Ø6.3 Flat washer		x 4

4

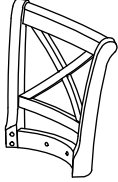

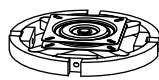
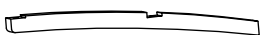
ITEM NO.	CTN NO.	INCLUDING
835-442BK/ WT	1	1 Chair back + 1 Seat cushion + 1 Seat Frame + 4 Chair legs + 1 Foot Rest + Hardware

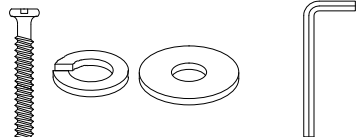
No	Product clusters inside carton	Reference Picture	Part	Qty
1	Chair back		A	1
2	Seat cushion		B	1
3	Seat frame		C	1
4	Chair legs		D	4
5	Foot rest		E	1
6	Hardware		AA, BB, CC, DD, EE, FF	58