

835-222

C000000

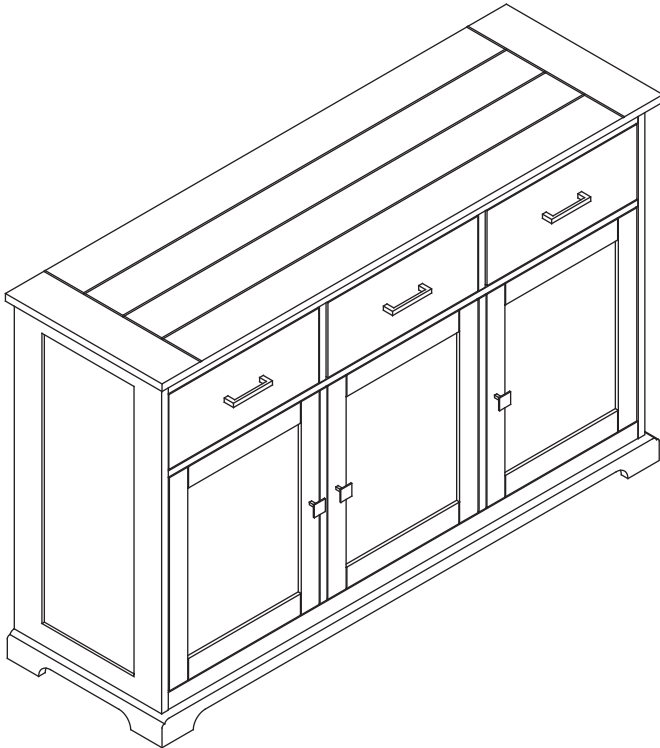





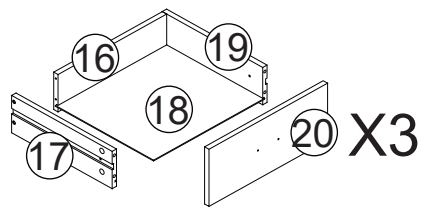
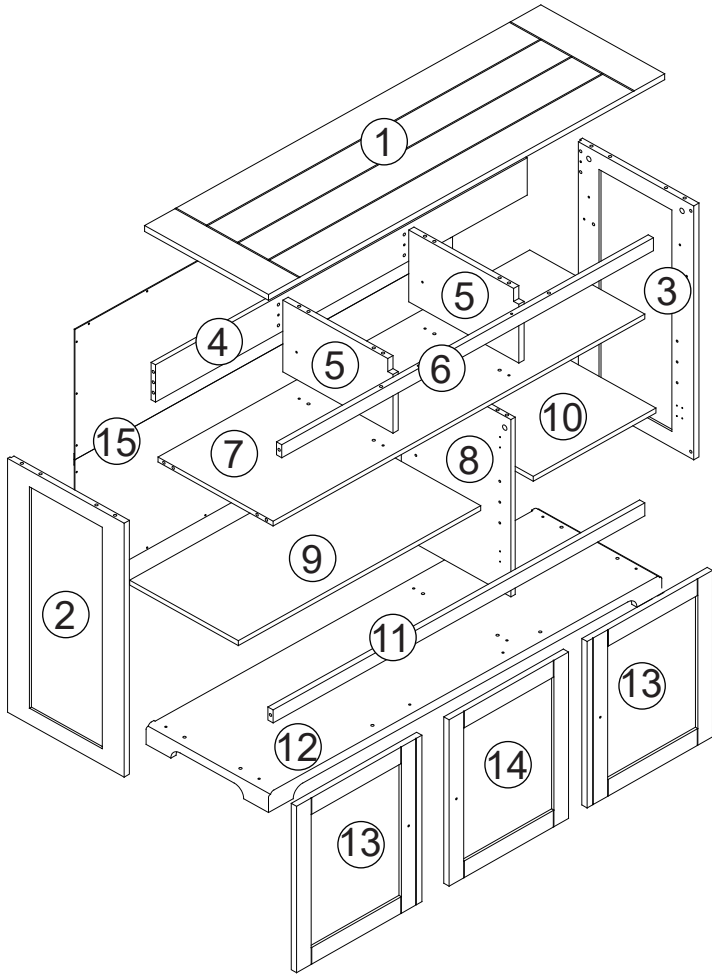



Please read these instructions and warranty information carefully before use and keep them properly for future reference.





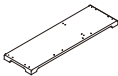













OPERATING INSTRUCTIONS



PACKING DETAILS:TOTAL 2 BOXES

BOX 1/2:









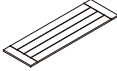

PART NO.	PART	QTY
2		x1
3		x1
5		x2
9		x1
10		x1
12		x1
15		x1
18		x3
20		x3

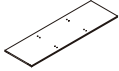
PART NO.	PART	QTY
A		x40
B	 5X40mm	x29
C	 7X43mm	x28
D		x28
E	 7X9mm	x16
F		x6
G		x4
H		x3
I	 4X12mm	x6
J		x2
K		x3
L	 3.5X14mm	x36
M		x4
N		x2
O		x1
P		x8
Q	 3X12mm	x23
R		x1

This product is packed in 2 outer boxes. Please install it after all. Thank you!

PACKING DETAILS:TOTAL 2 BOXES

BOX 2/2:

PART NO.	PART	QTY
1		x1
4		x1
6		x1
7		x1
8		x1
11		x1
13		x2
14		x1
16		x3
17		x3
19		x3

This product is packed in 2 outer boxes.Please install it after all.Thank you!

Assembly Instructions

1

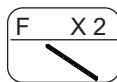
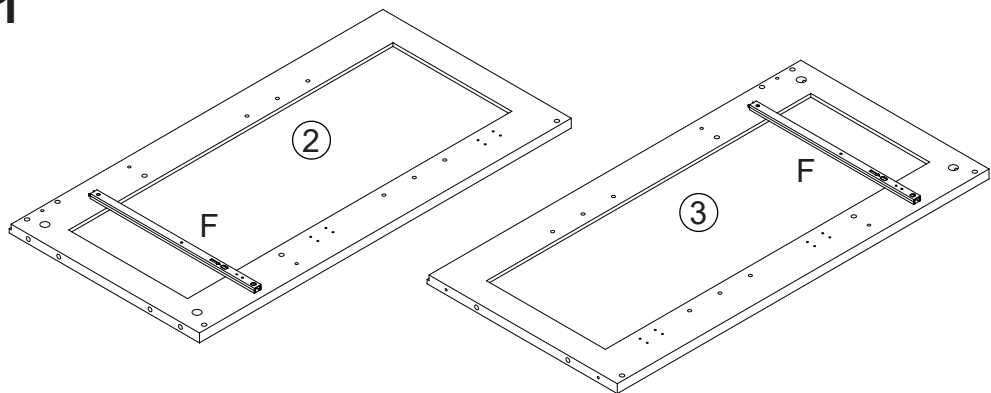

2

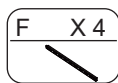
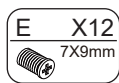
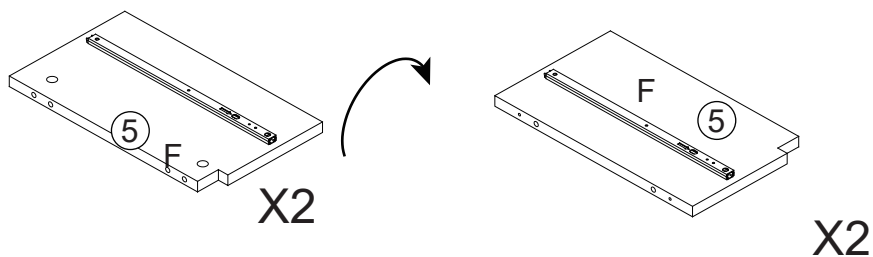

Assembly Instructions

3

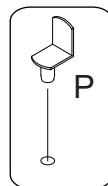
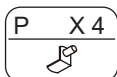
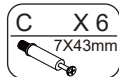
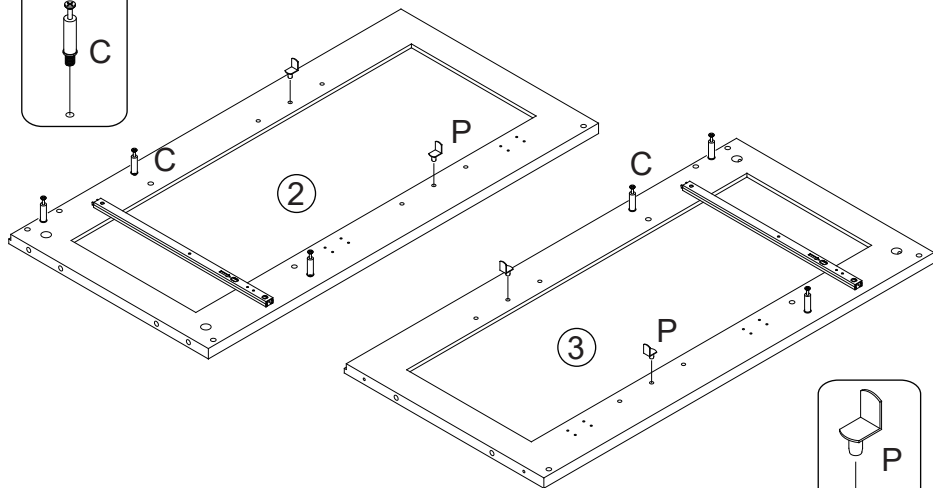
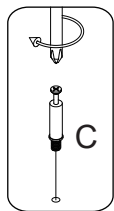

4

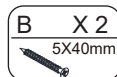
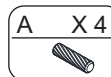
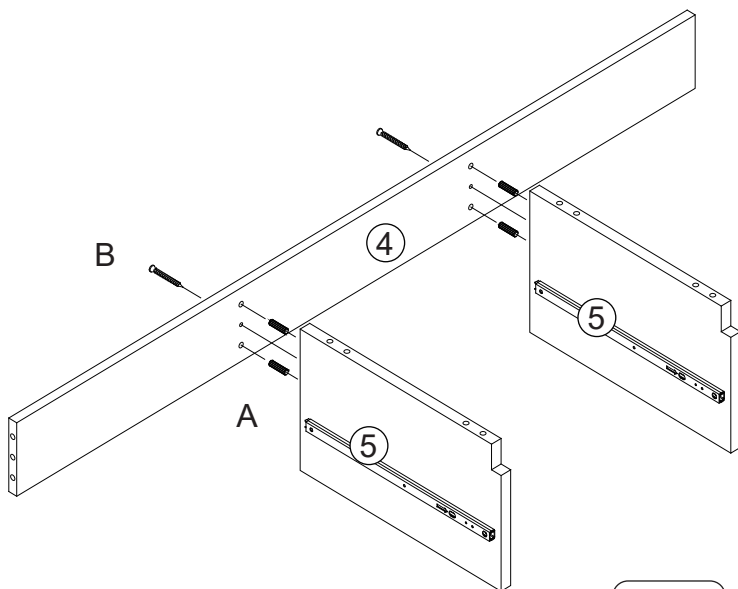

Assembly Instructions

5

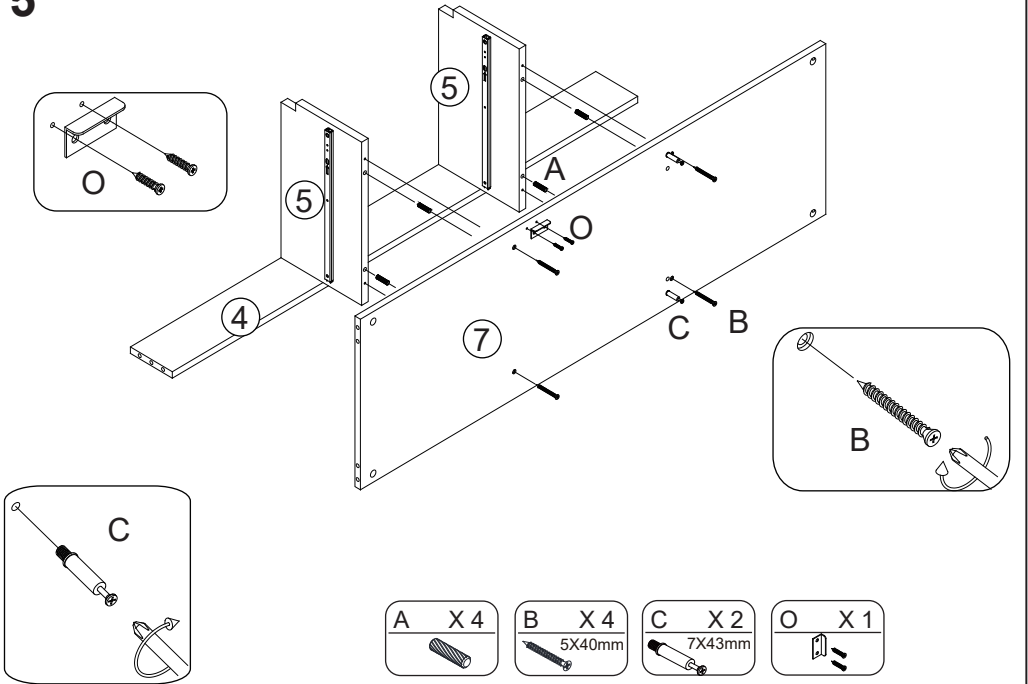

6

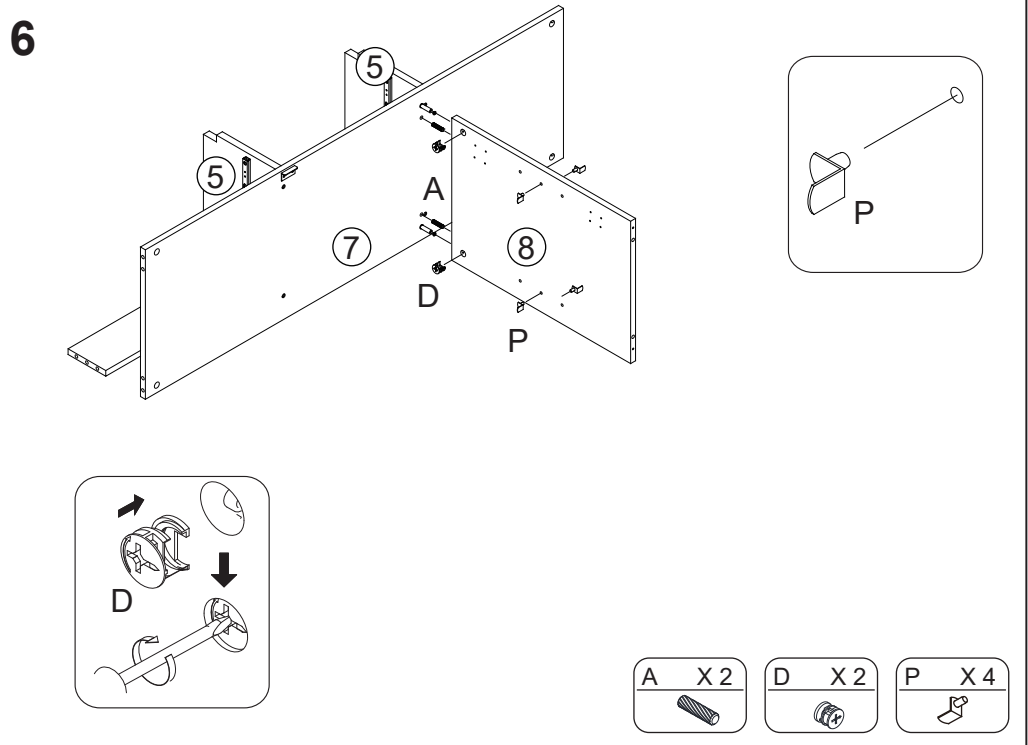

Assembly Instructions

7

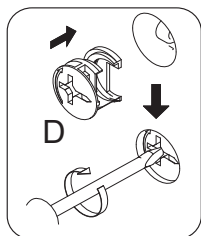
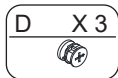
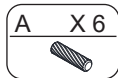
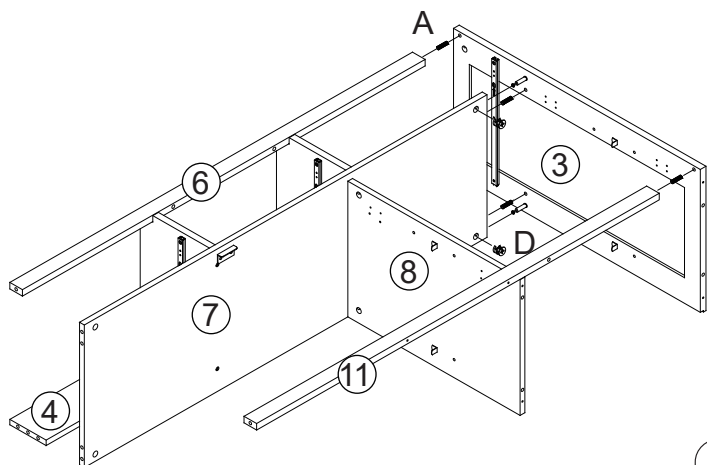

8

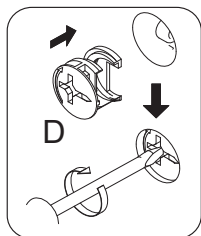
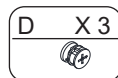
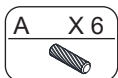
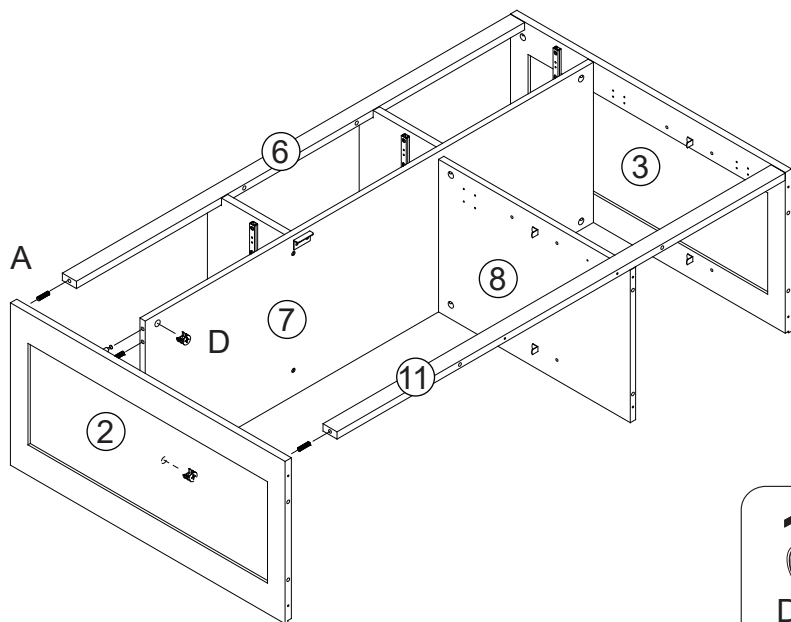

Assembly Instructions

9

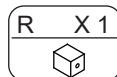
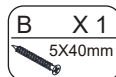
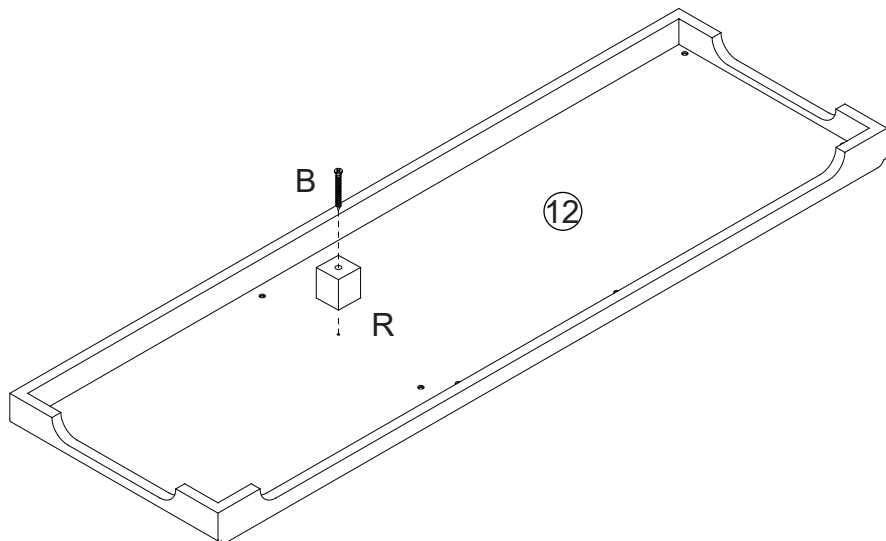

10

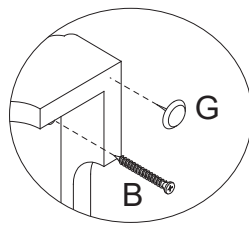
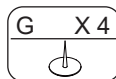
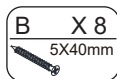
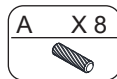
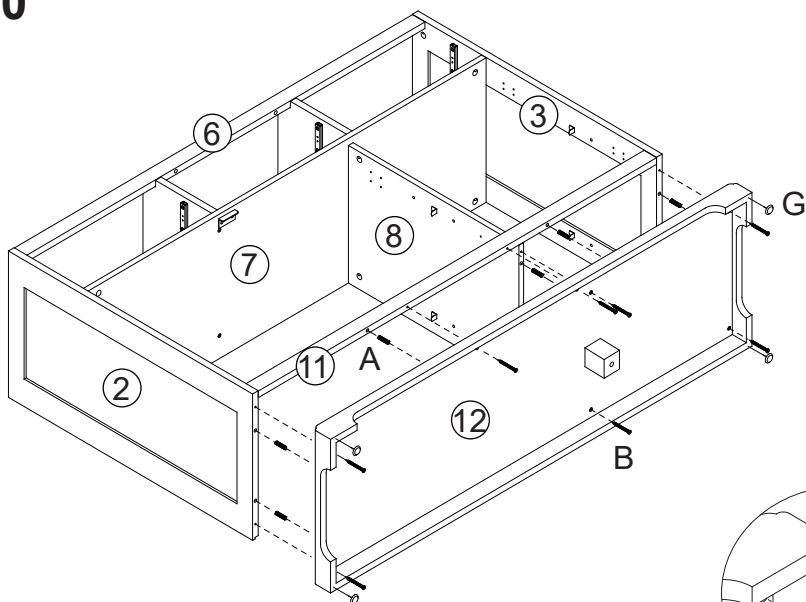

Assembly Instructions

11

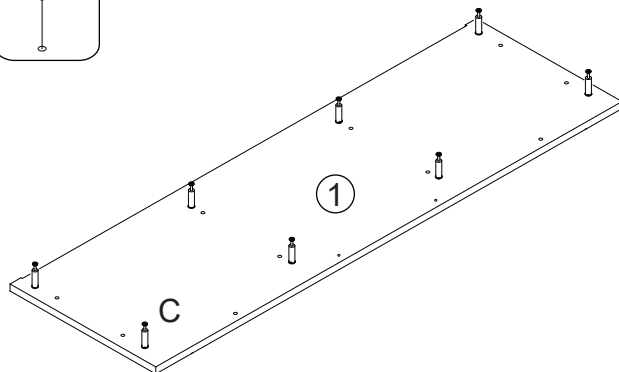
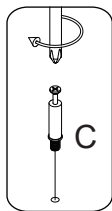

12

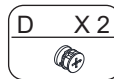
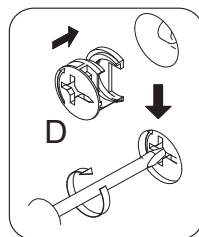
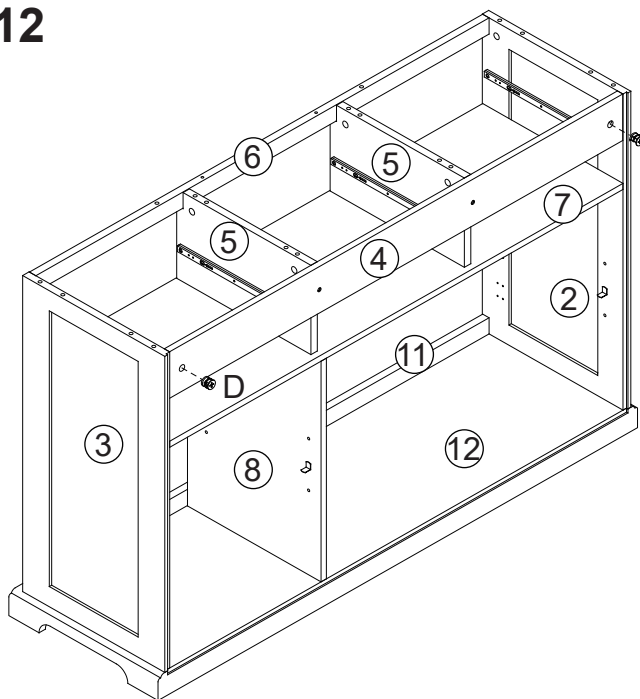

Assembly Instructions

13

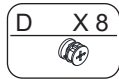
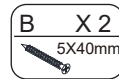
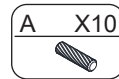
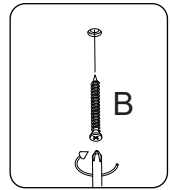
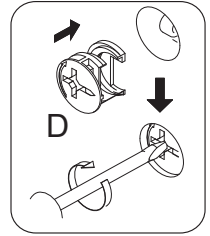
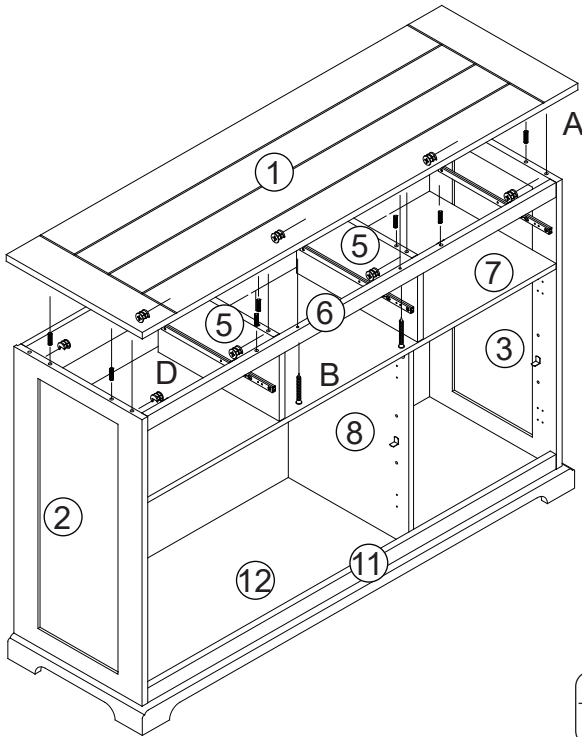

14

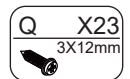
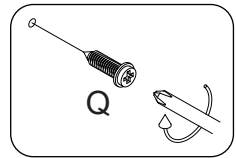
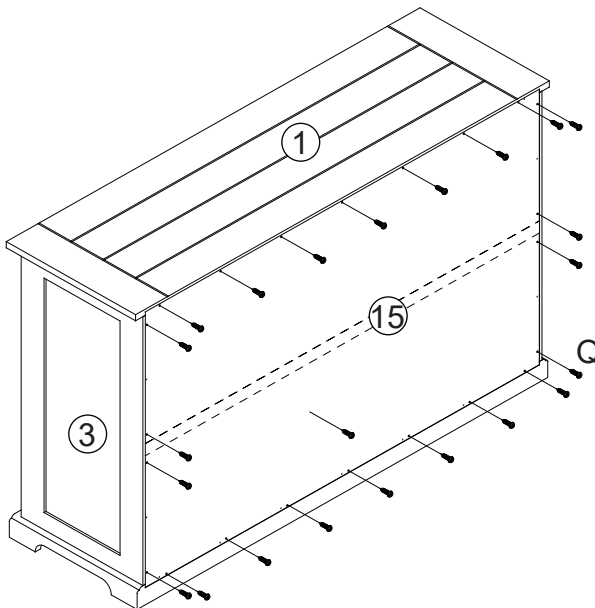

15

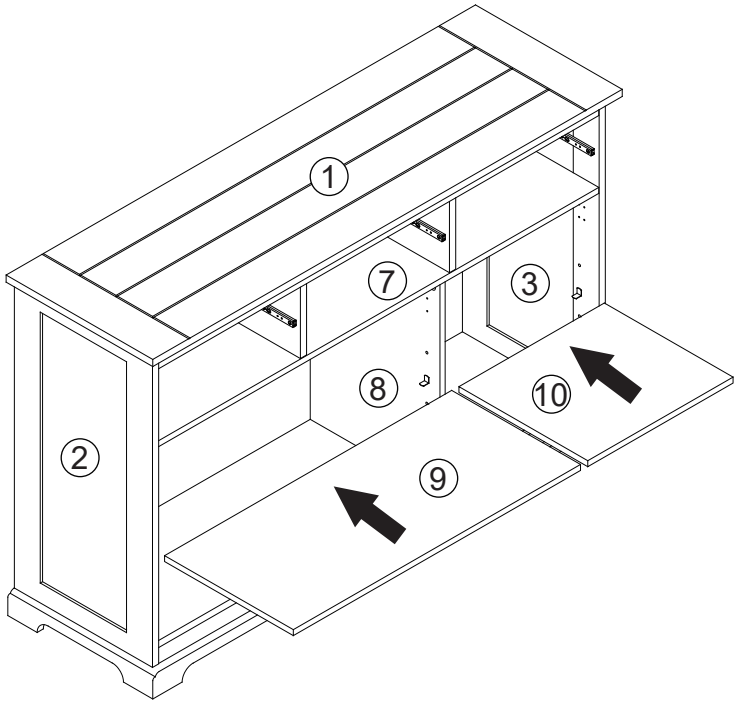

16

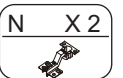
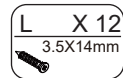
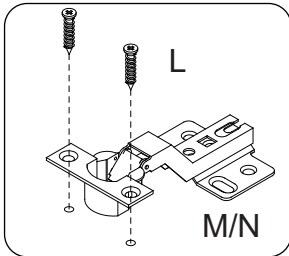
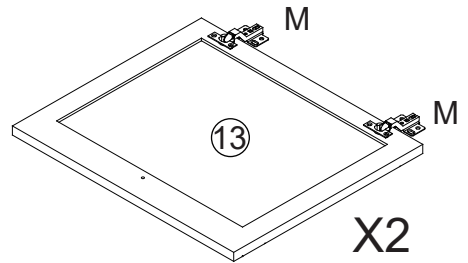
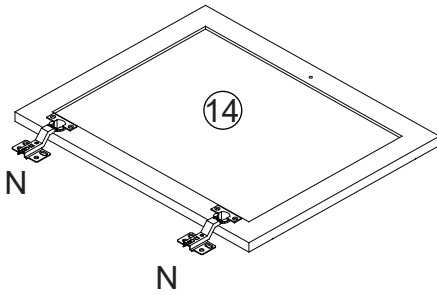

Assembly Instructions

17

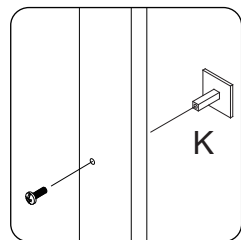
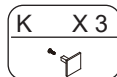
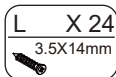
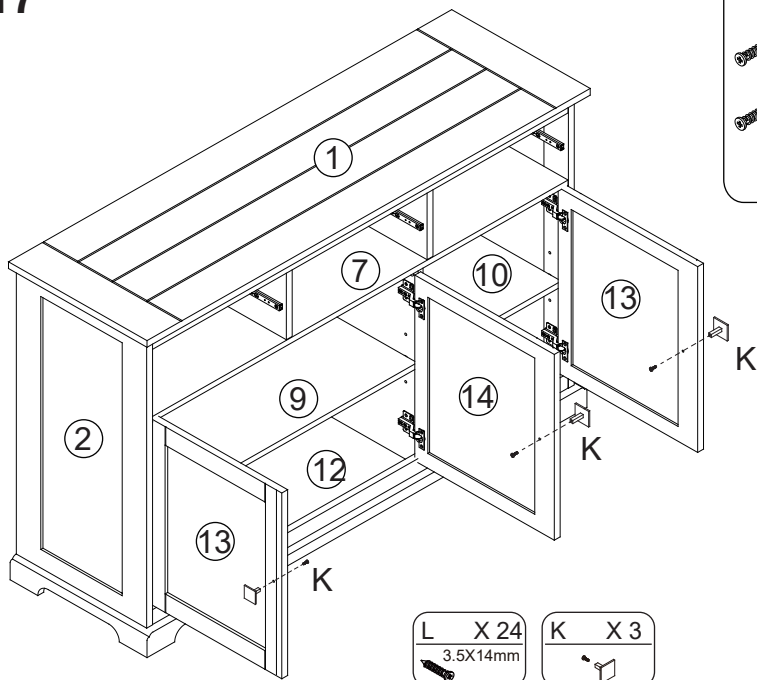

18

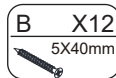
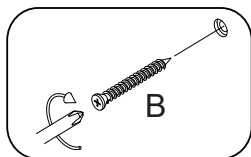
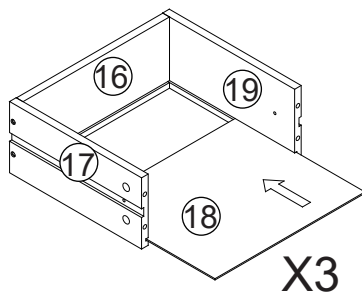
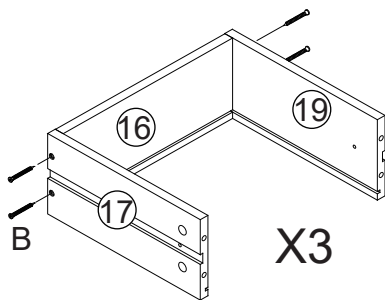

Assembly Instructions

19

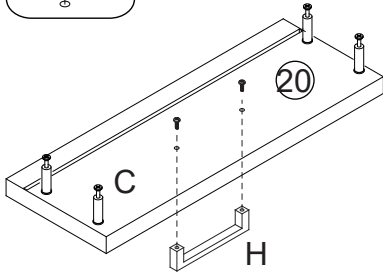
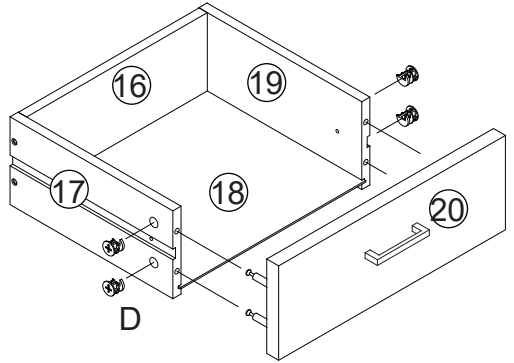
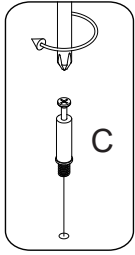

X3

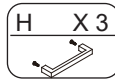
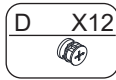
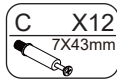
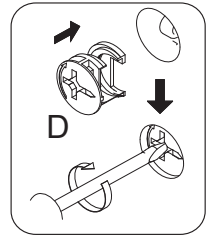

20

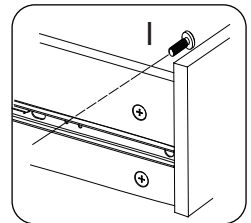
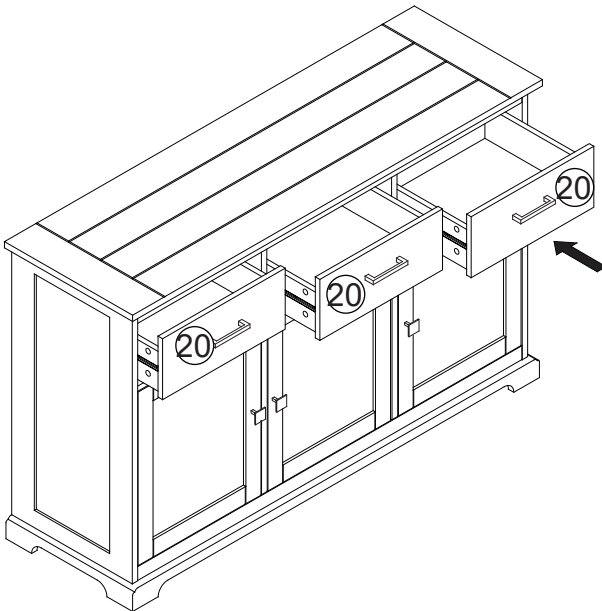

21

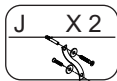
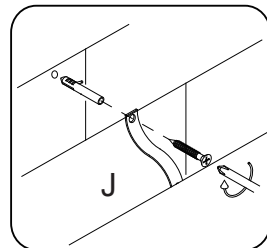
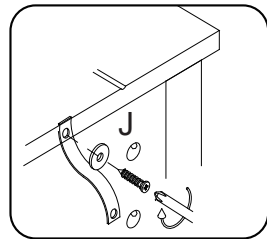
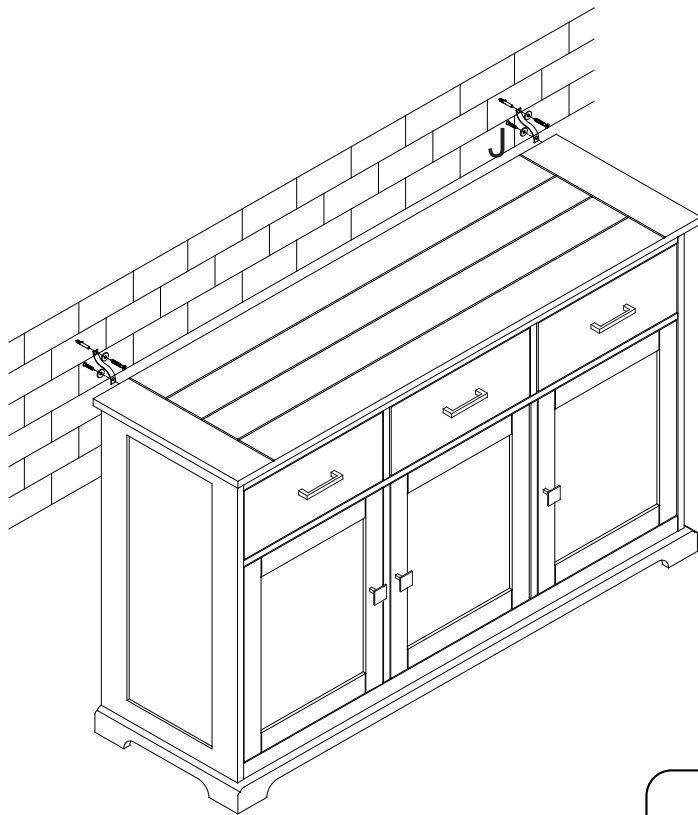

Assembly Instructions

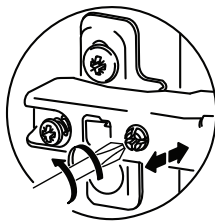
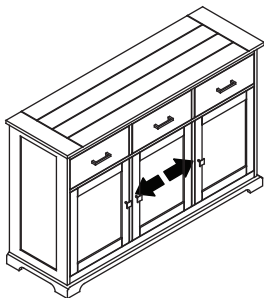
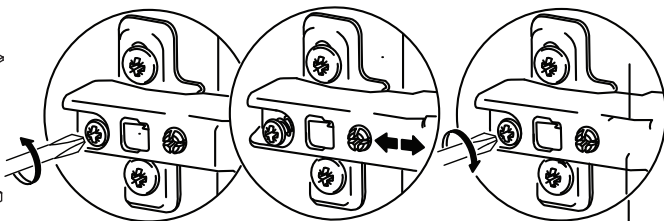
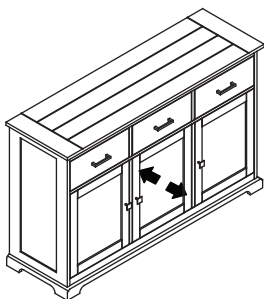
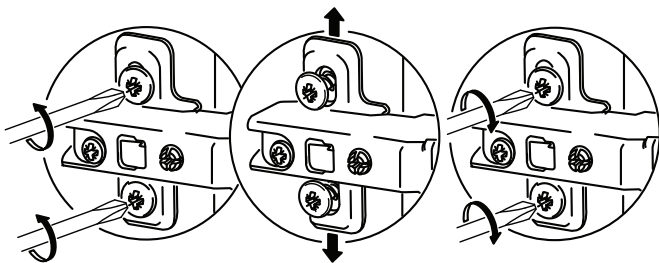
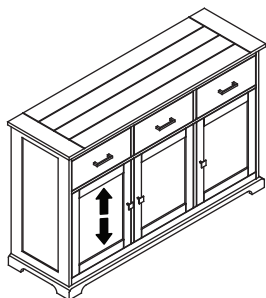



001-877-644-9366
customerservice@aosom.com



001-855-537-6088
customerservice@aosom.ca



0044-800-240-4004
enquiries@mhstar.co.uk



0049-(0)40-88307530
service@aosom.de



0033-1-84166106
contact@aosom.fr



0034-931294512
atencioncliente@aosom.es



0039-0249471447
clienti@aosom.it