

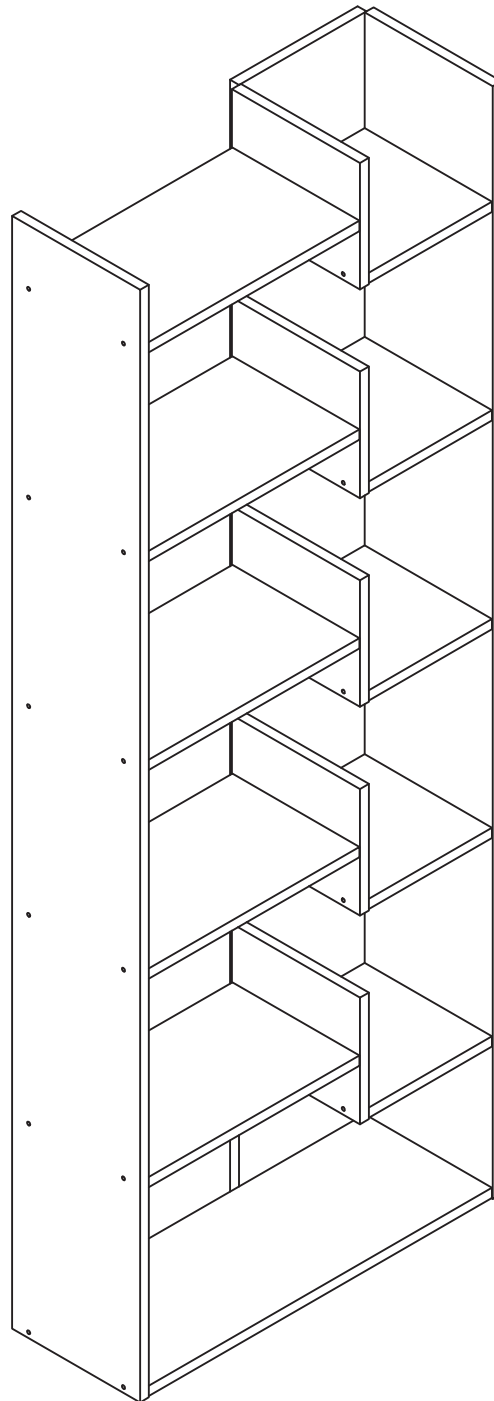

INc8b004_US_CA_UK_ES_DE_IT

836-541V01



IMPORTANT, RETAIN FOR FUTURE REFERENCE: READ CAREFULLY

ASSEMBLY INSTRUCTION

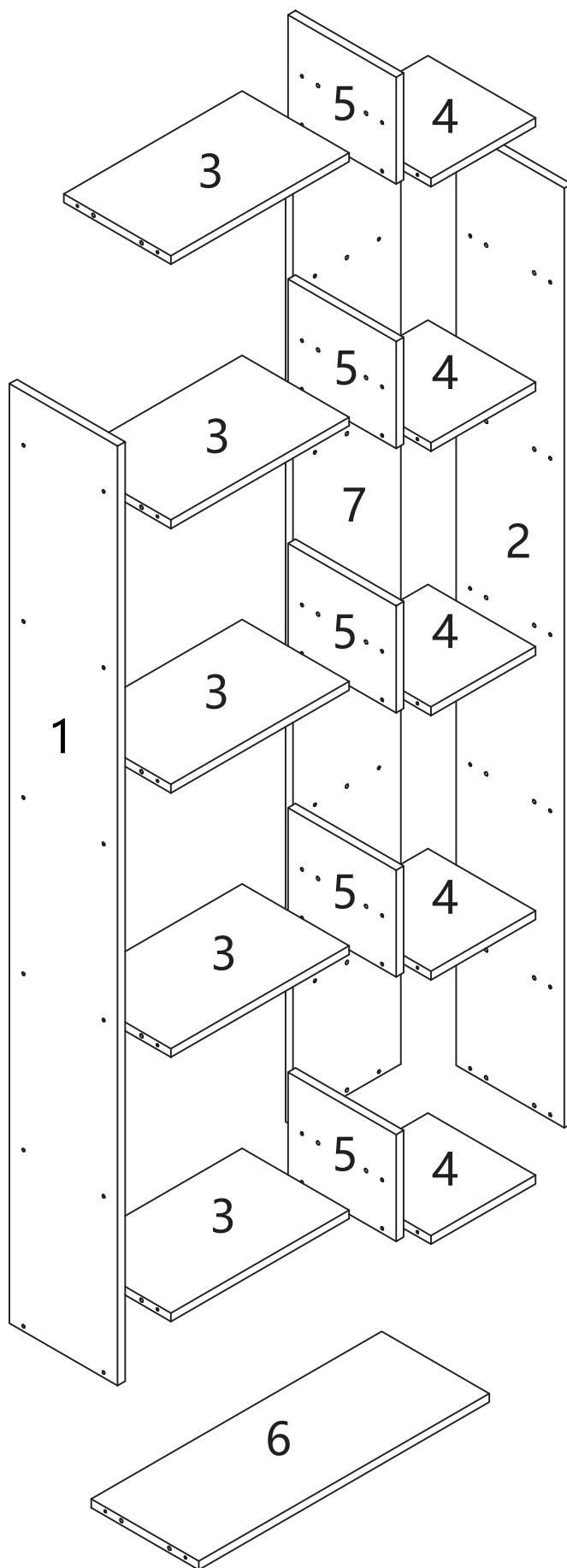

①x 1

one side

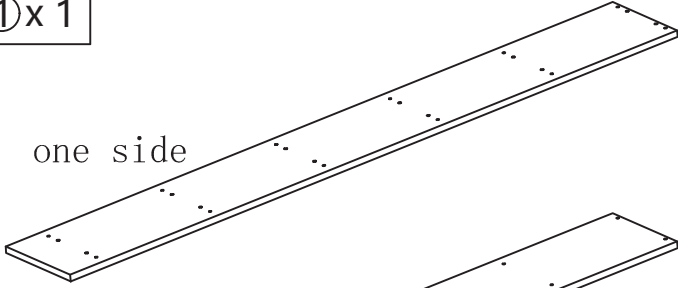

the other side

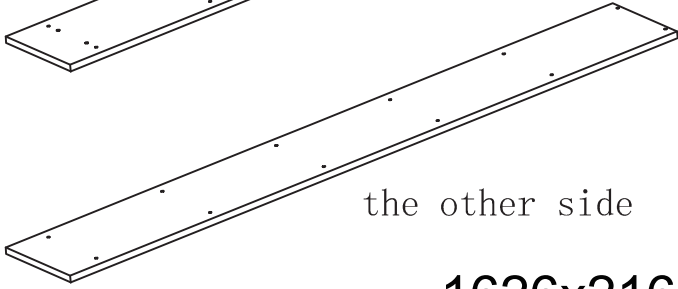

1626x216mm

②x 1

one side

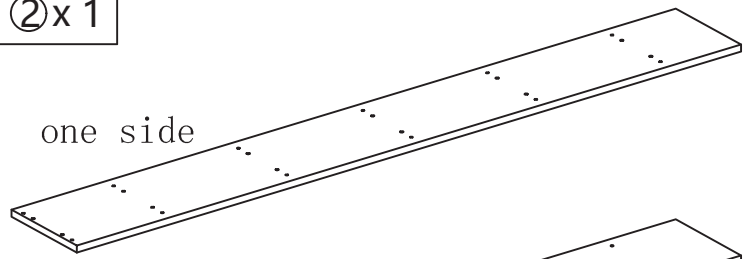

the other side

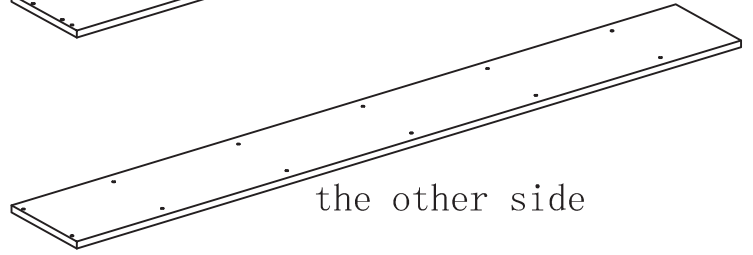

1626x216mm

③x 5

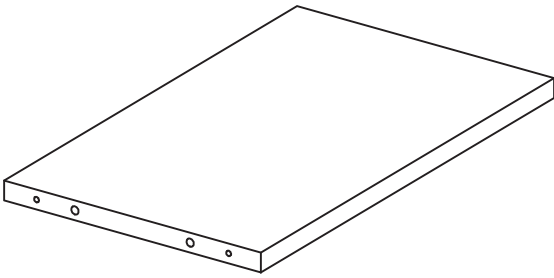

356x214mm

④x 5

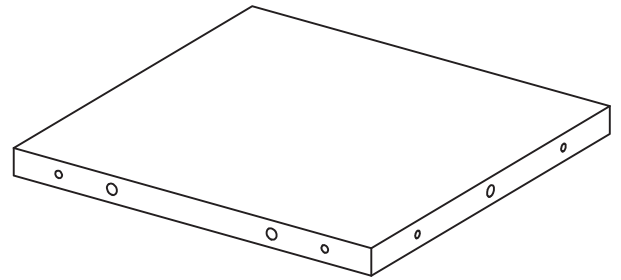

209x215mm

⑤x 5

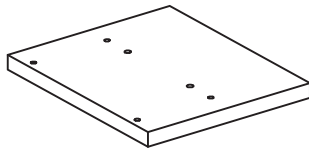

one side

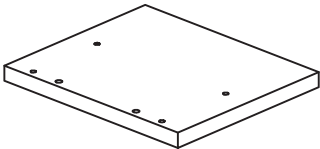

the other side

185x216mm

⑥x 1

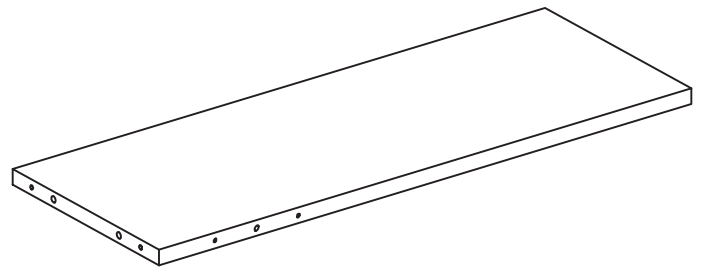

580x215mm

⑦x 1

one side

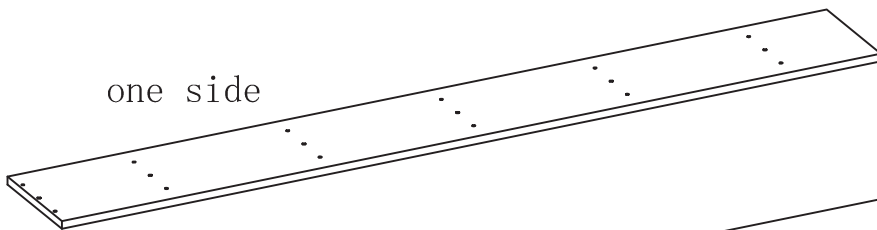

the other side

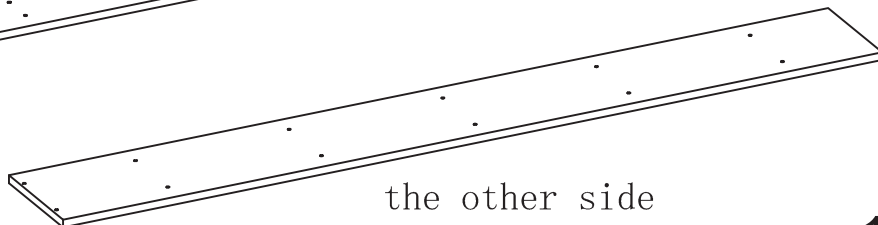

1626x228mm

A x50

+2(spare)

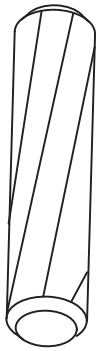

M8*30

B x56

+2(spare)

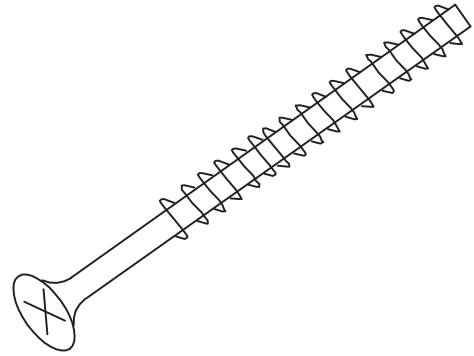

HARDWARE

M5*50

C x4

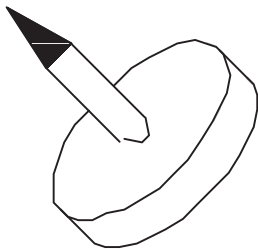

D x2

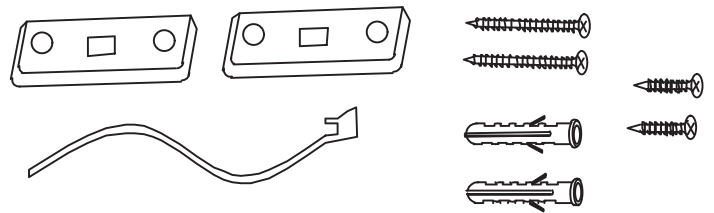

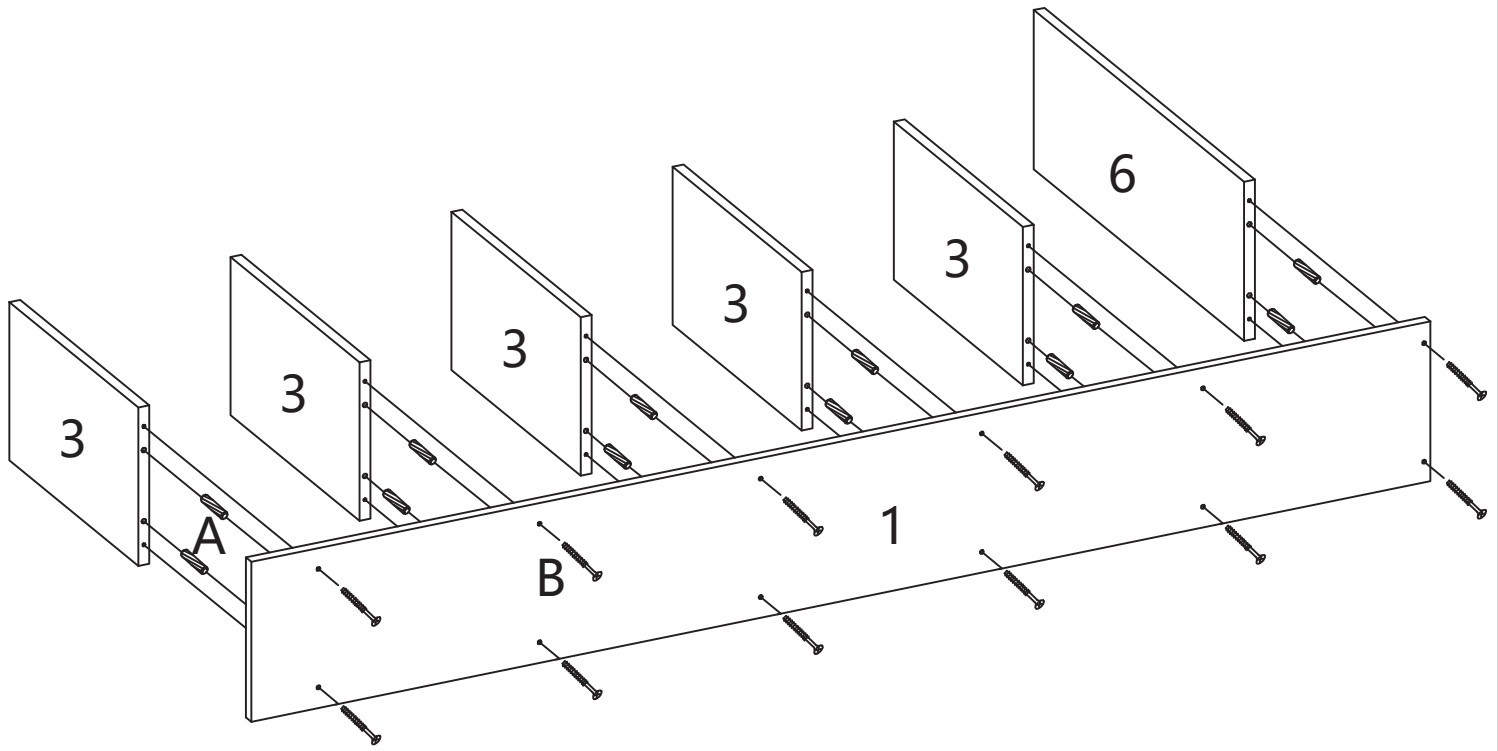

1

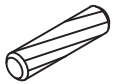

B X12	A X12
	

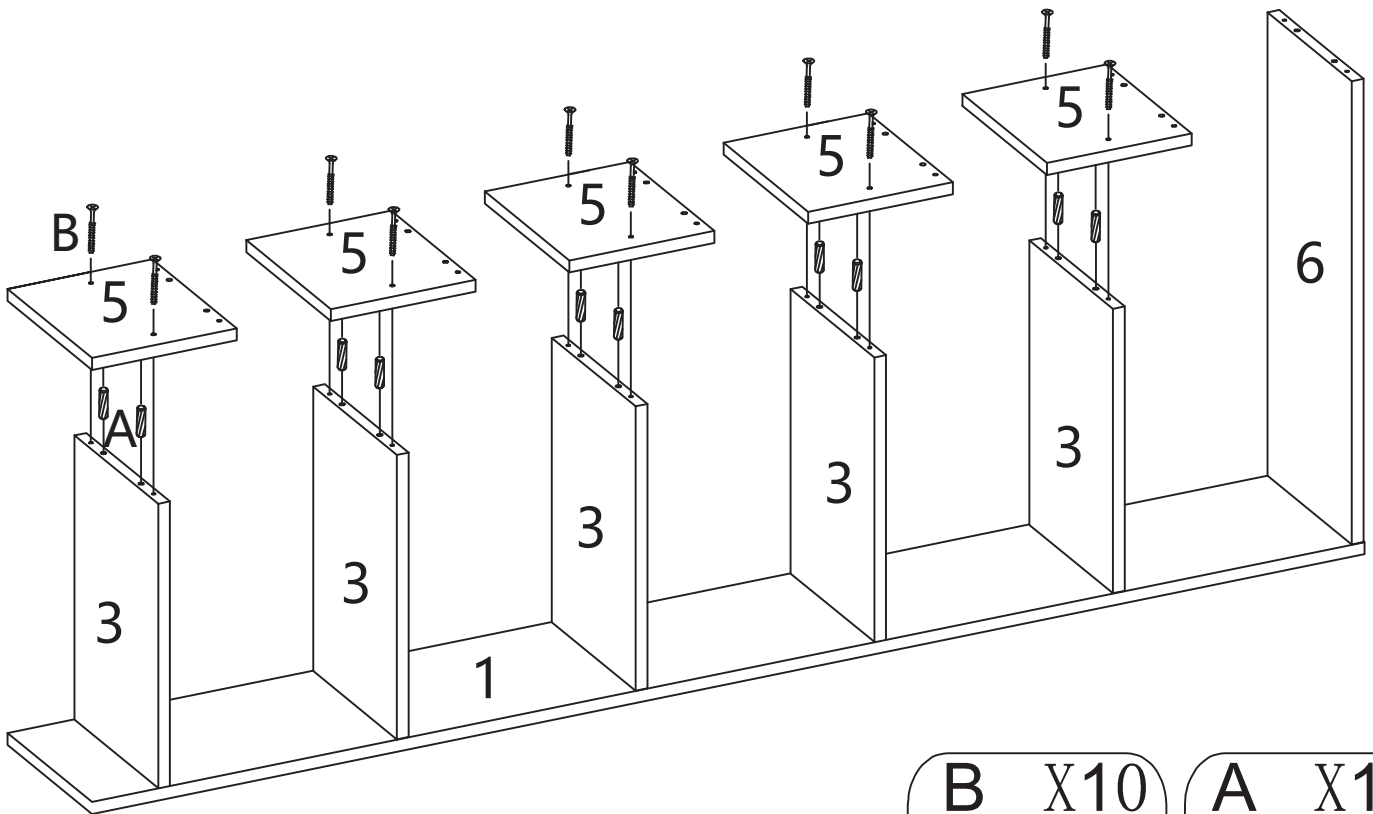
2

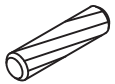

B X10	A X10
	

3

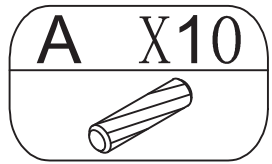
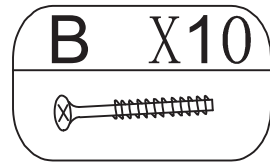
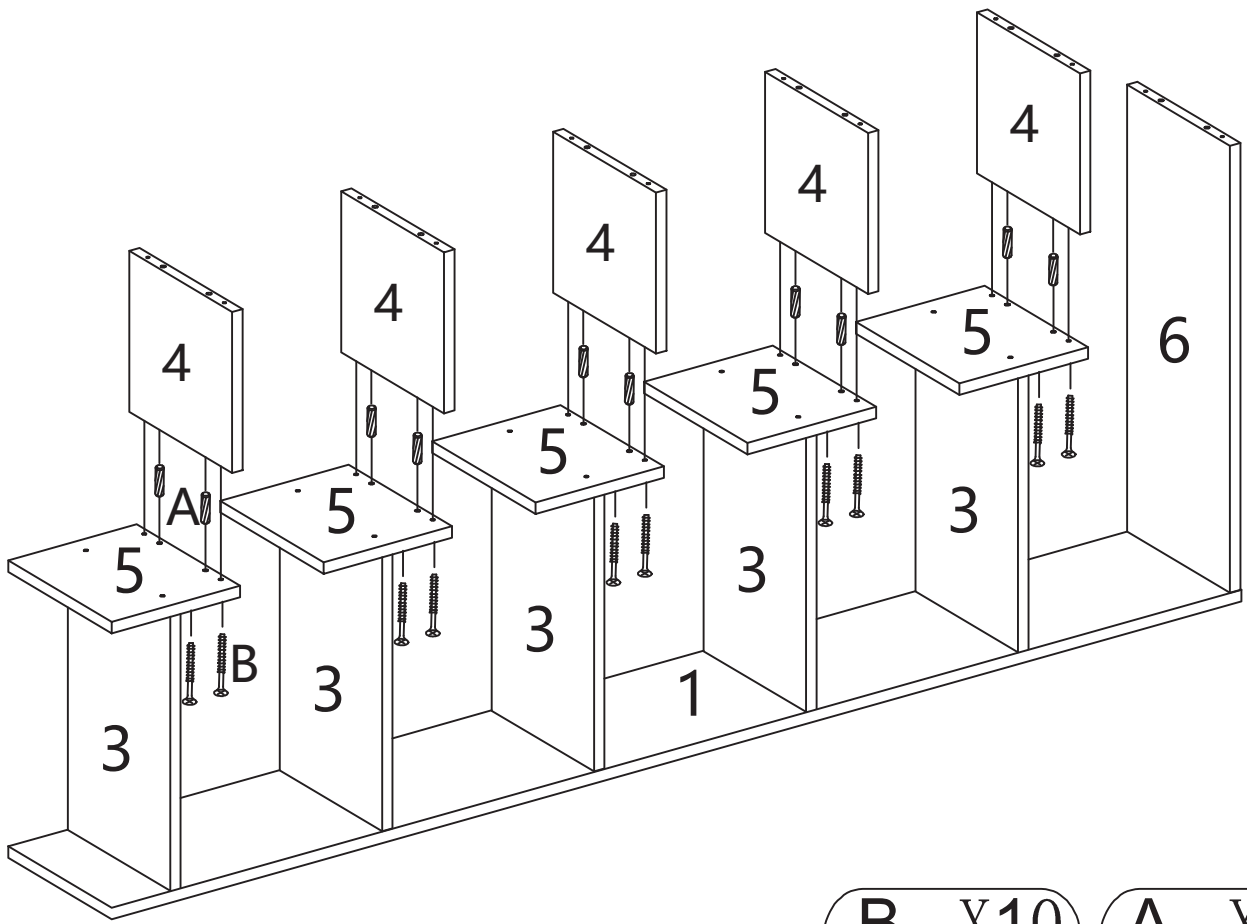

4

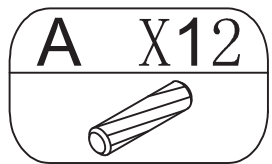
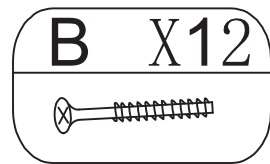
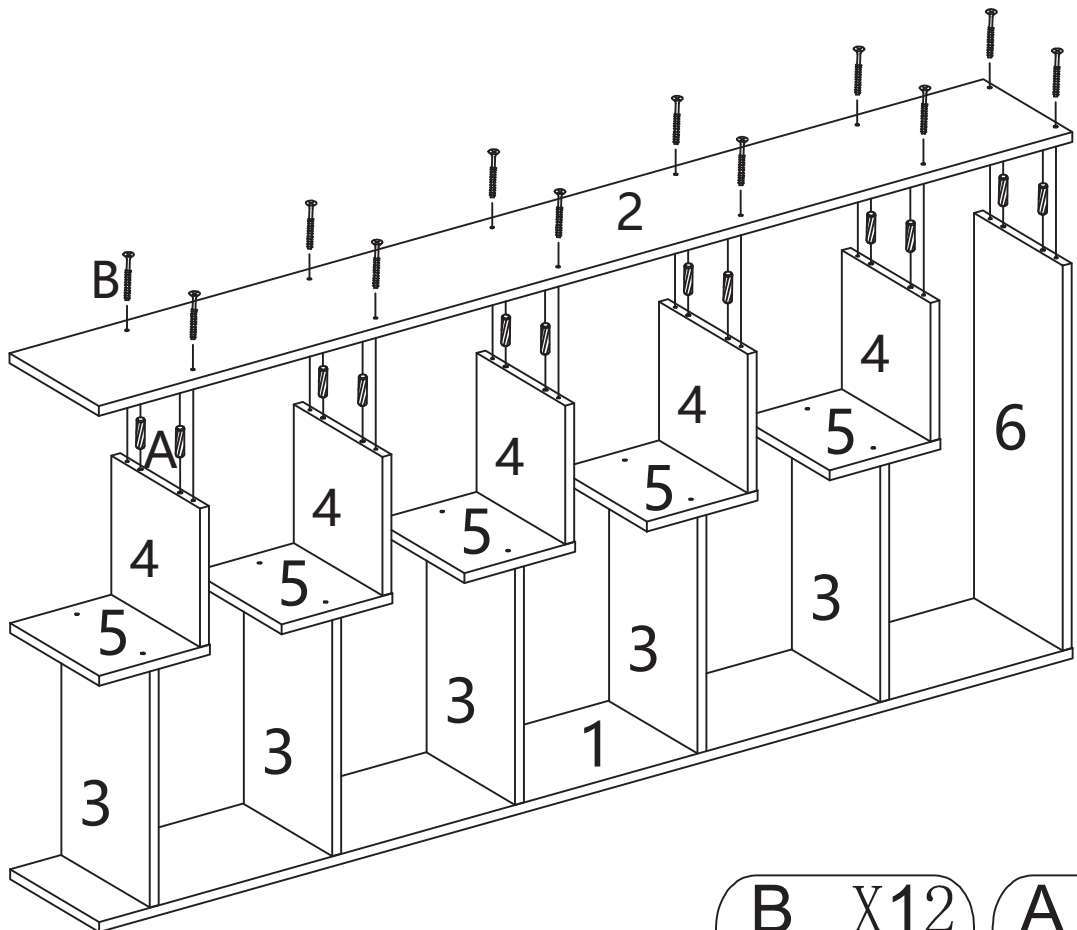

5

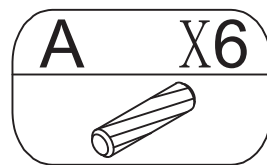
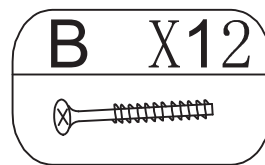
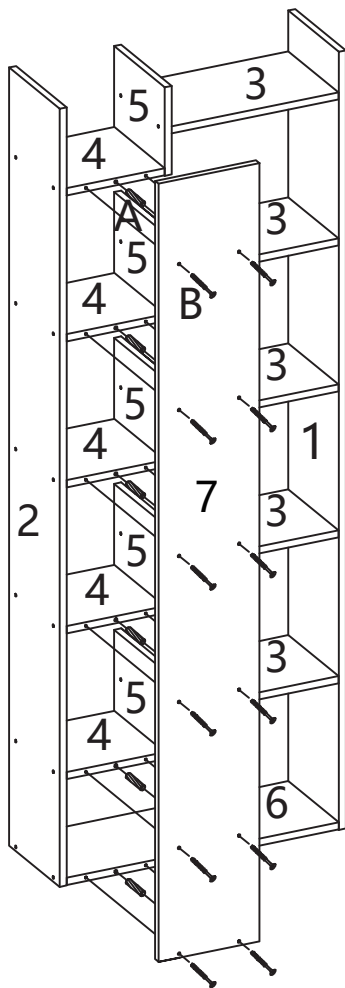

6

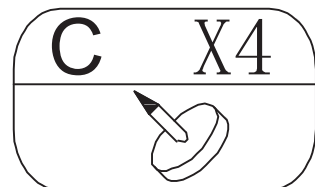
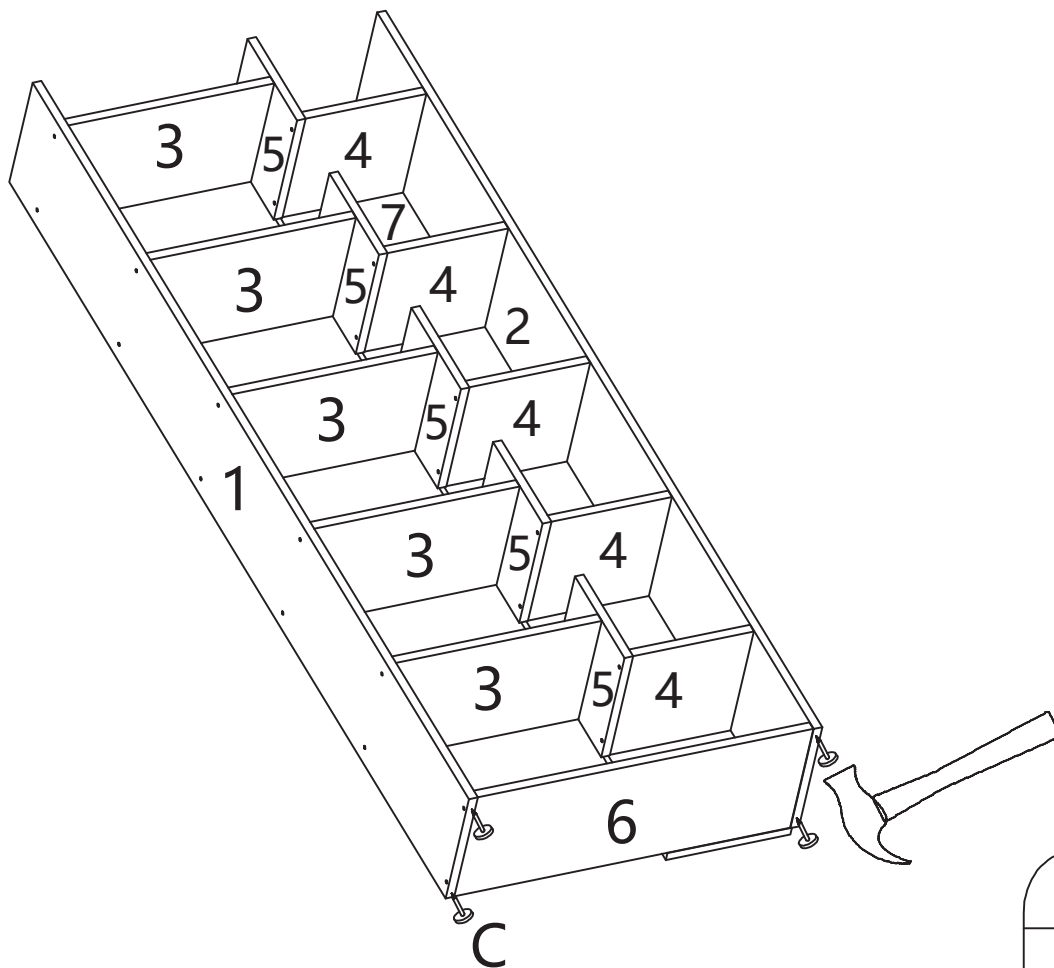

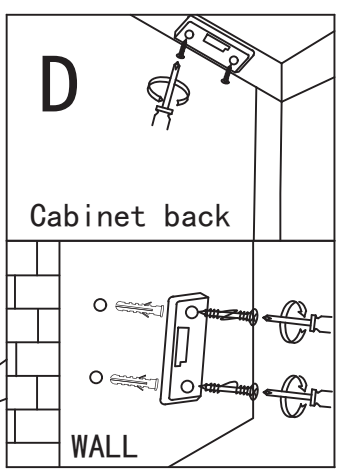
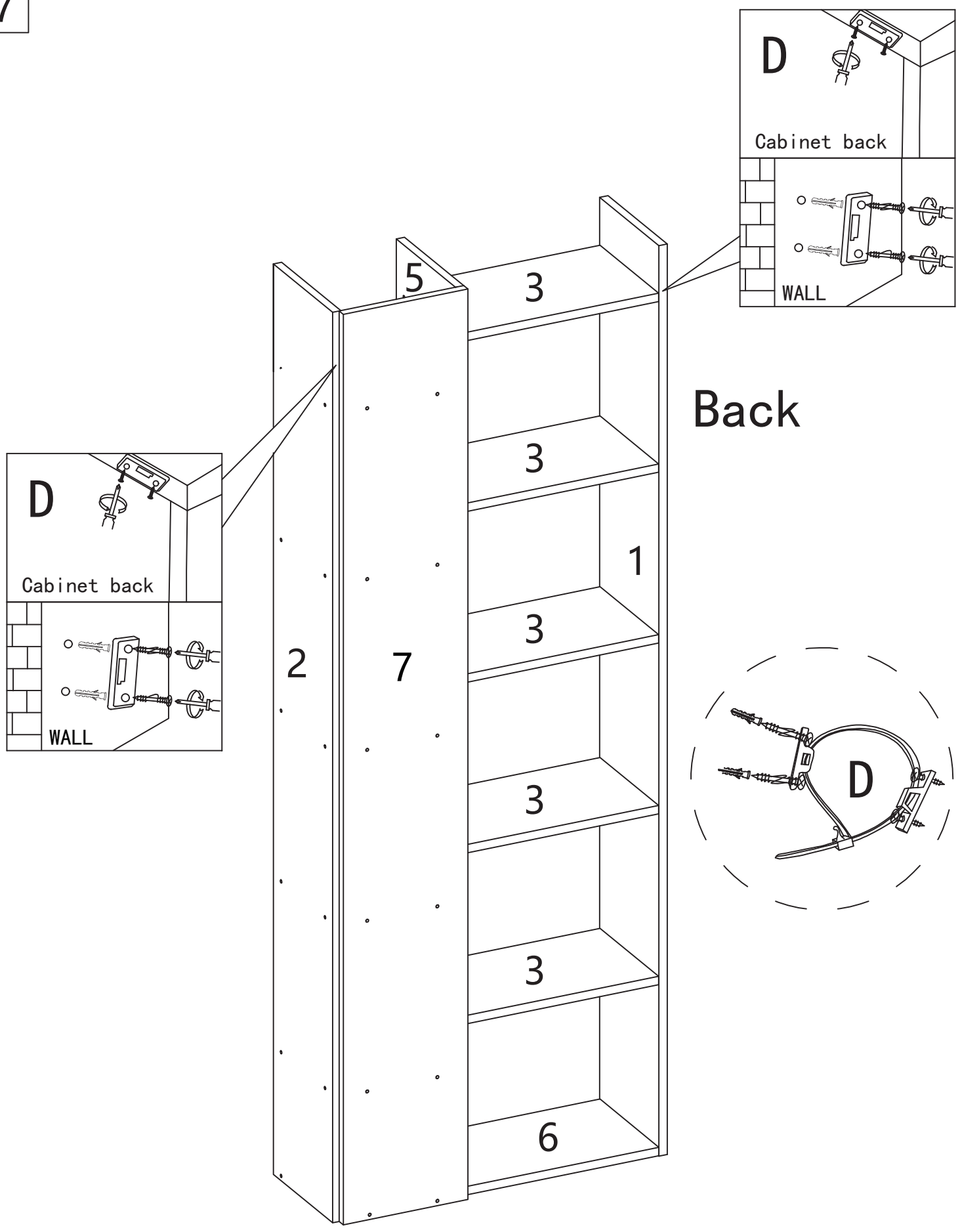

Back

