

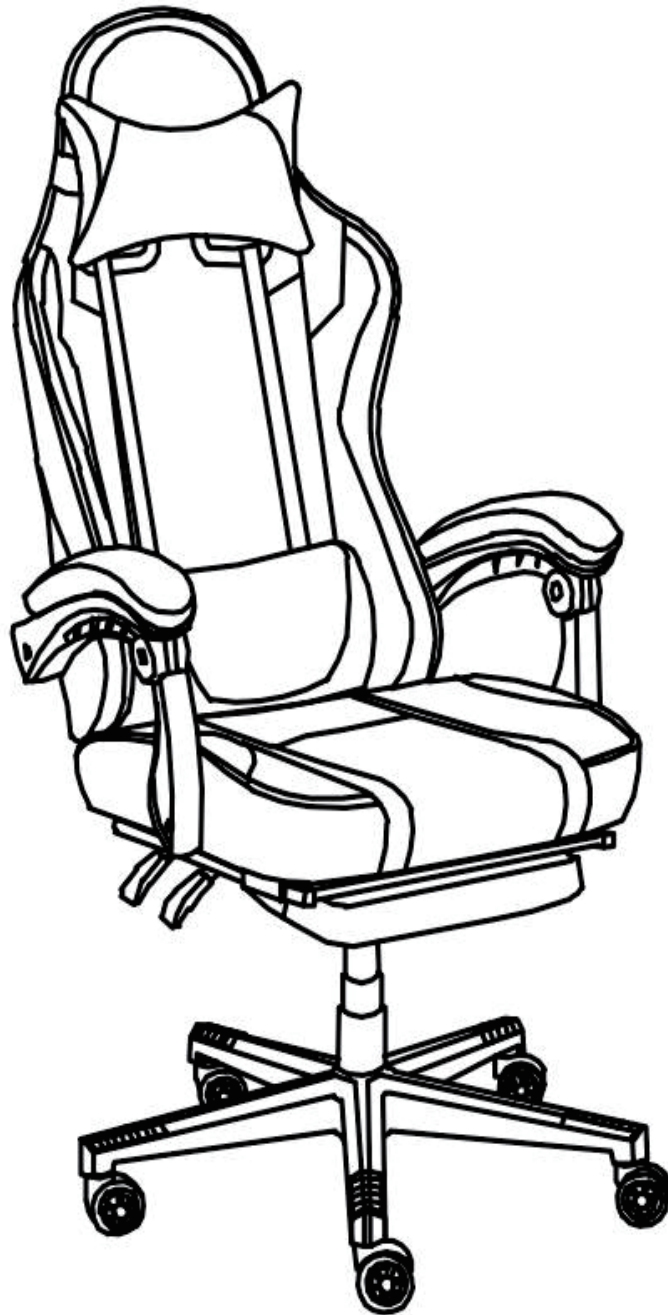











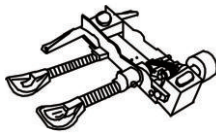
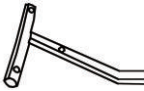

INcbd062_US_CA

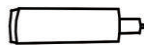
921-334

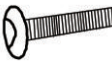
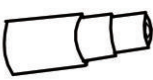

READ AND SAVE THIS INSTRUCTIONS FOR FUTURE USE

ASSEMBLY & INSTRUCTION MANUAL

A x 1	D x 1	H x 1	L x 4
			
B x 1	E x 1	I x 4	M x 1
			
C x 1	F x 5	M6*20; J x 4	N x 1
			
	G x 2	M8*40; K x 3	O x 4
			
		M6*35;	

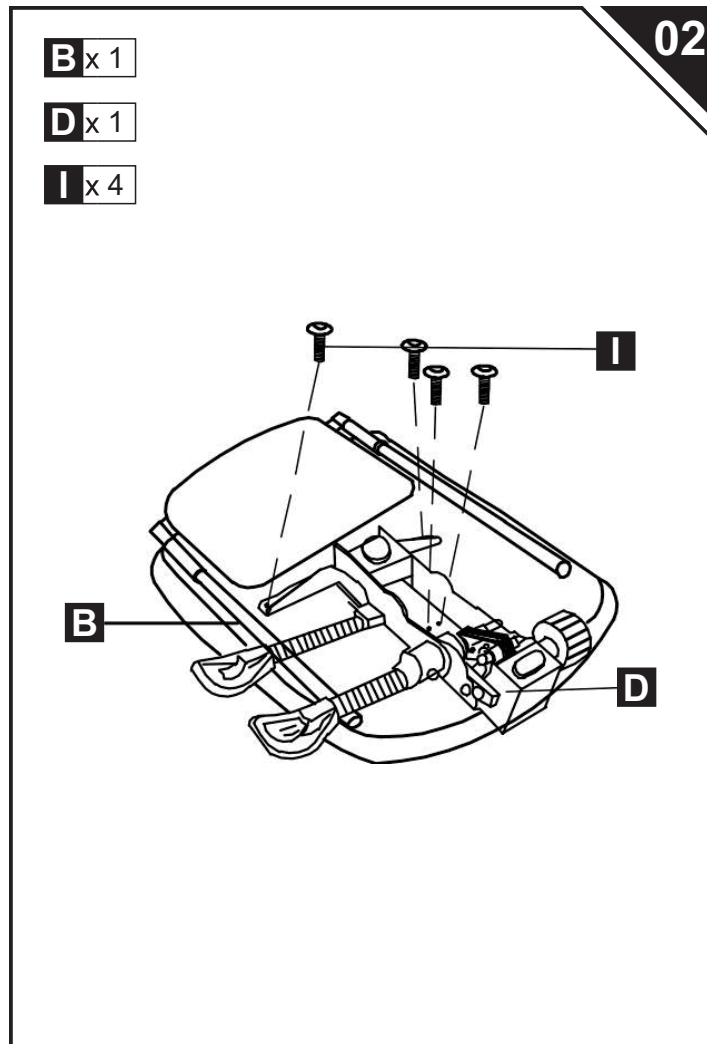
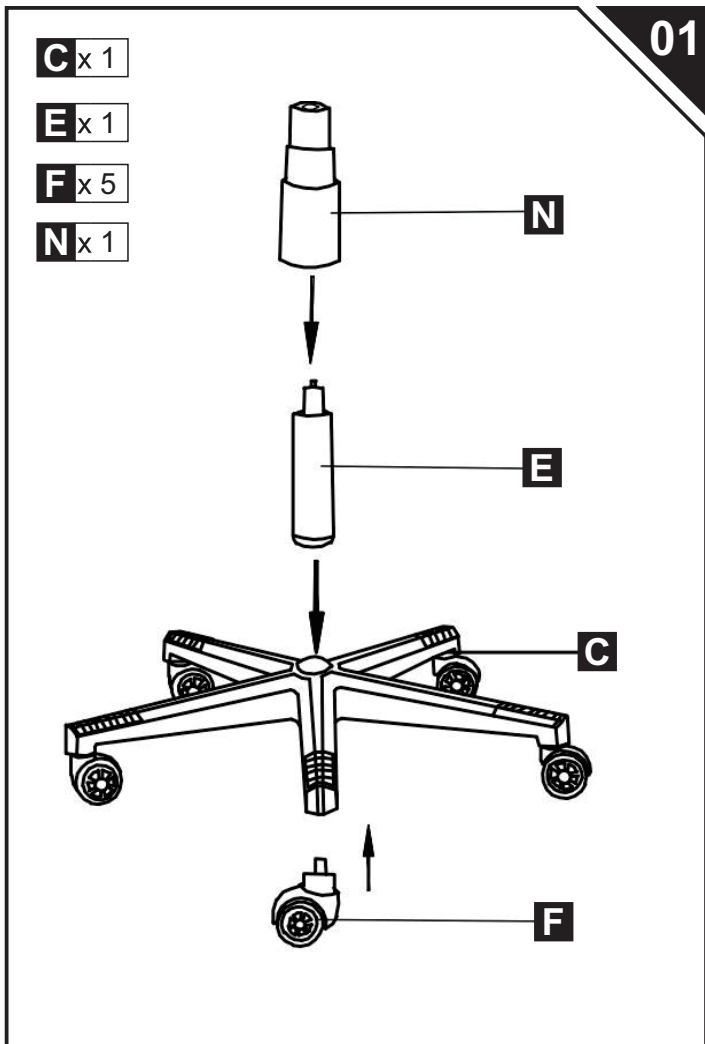

03

A x 1

H x 1

K x 3

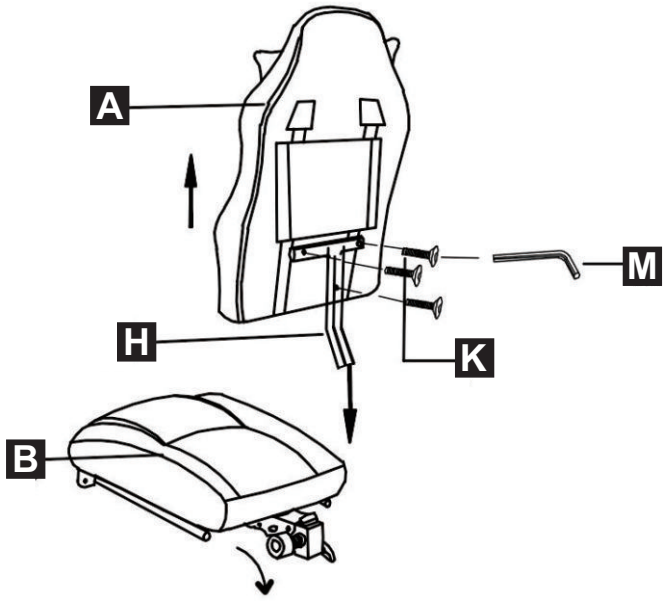

04

G x 2

J x 4

L x 4

O x 4

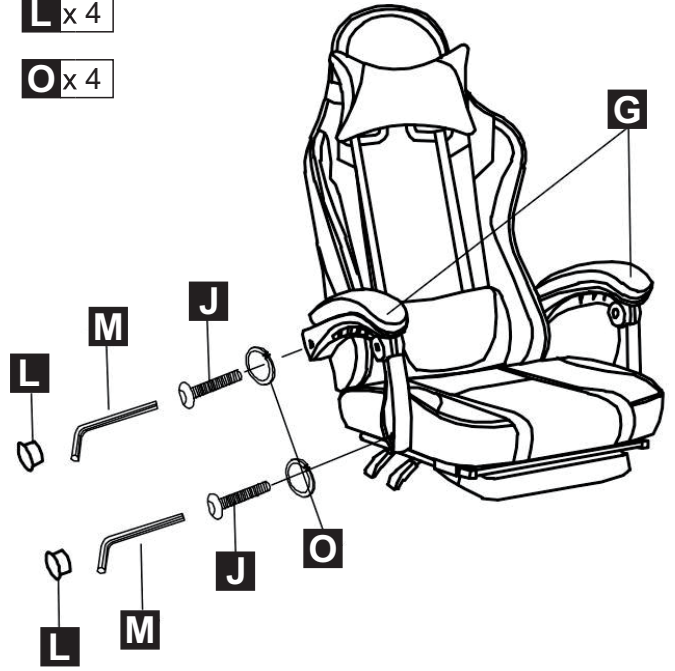

05

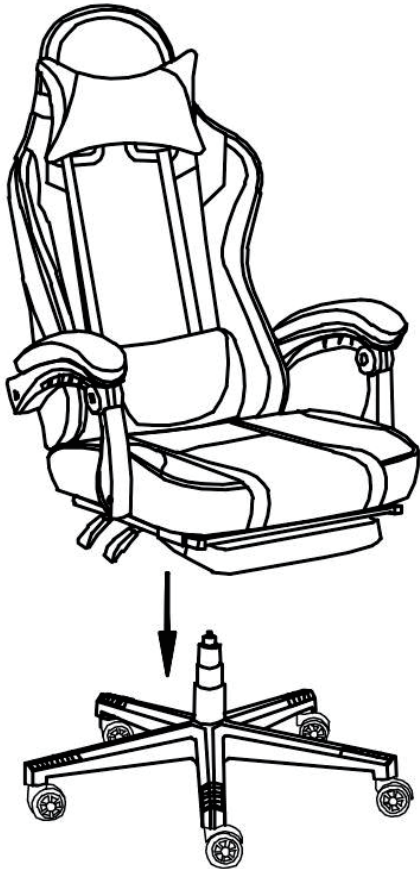

06

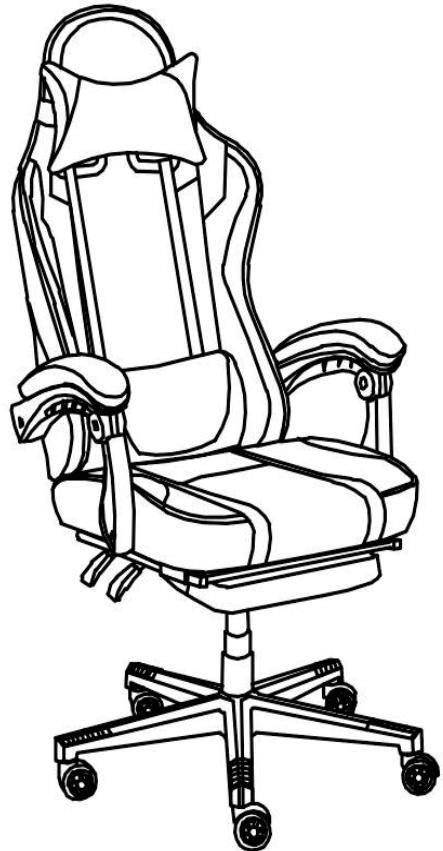

07

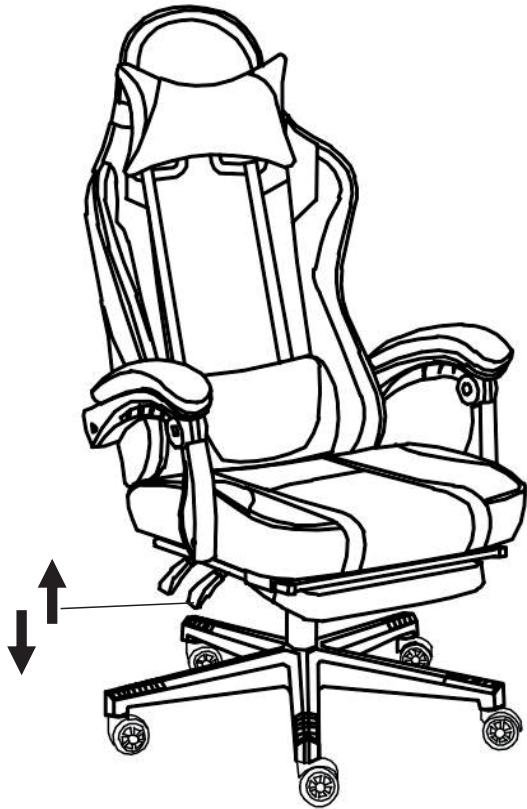

08

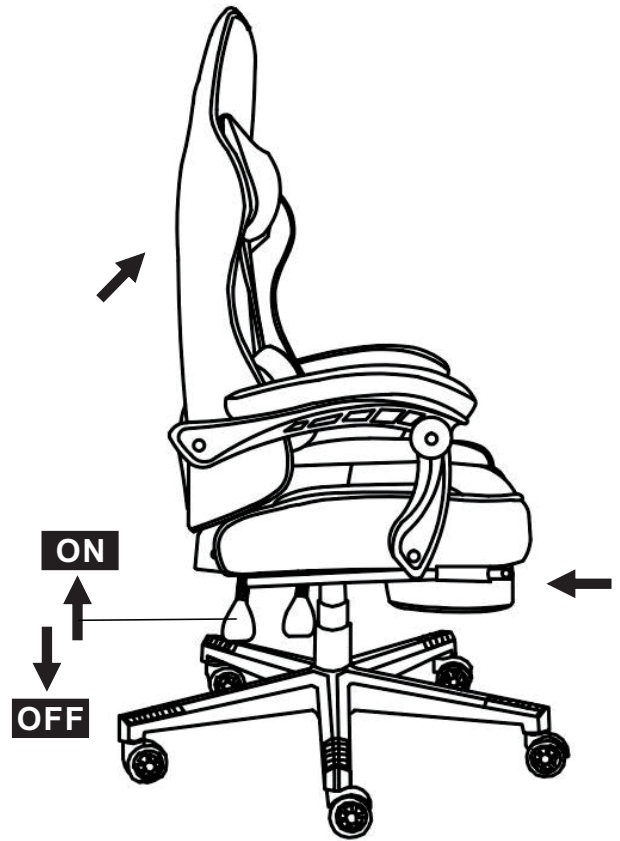

09

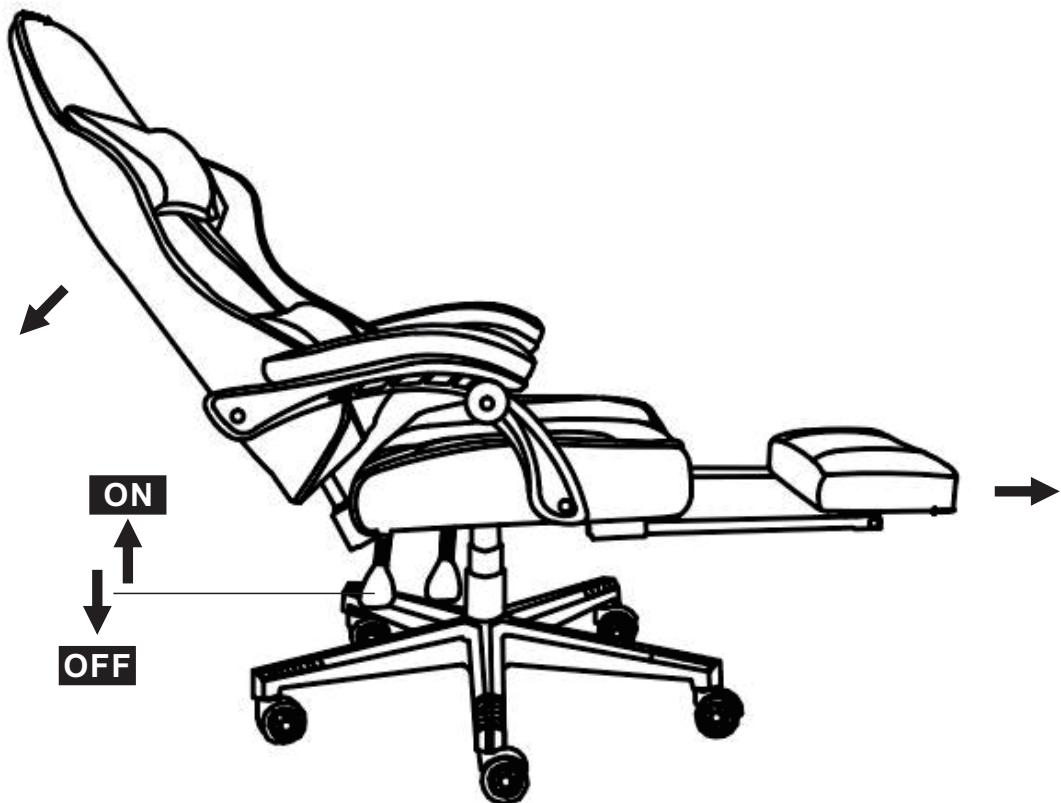

Done

US



001-877-644-9366
customerservice@aosom.com

CA



001-855-537-6088
customerservice@aosom.ca

UK



0044-800-240-4004
enquiries@mhstar.co.uk

DE



0049-(0)40-88307530
service@aosom.de

FR



0033-1-84166106
contact@aosom.fr

ES



0034-931294512
atencioncliente@aosom.es

IT



0039-0249471447
clienti@aosom.it