

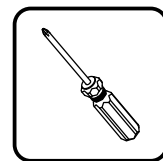

INccc047V01\_GL

**835-254**

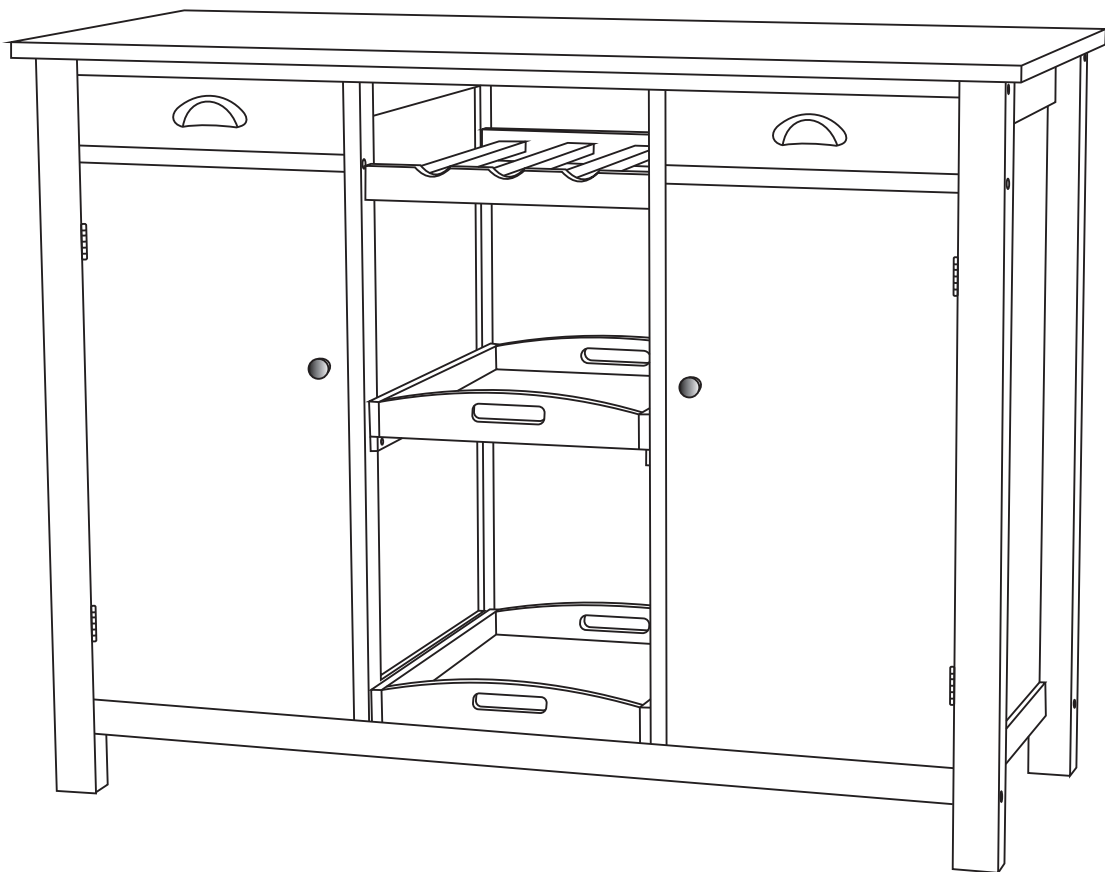

IMPORTANT, RETAIN FOR FUTURE REFERENCE: READ CAREFULLY

# ASSEMBLY INSTRUCTION

① x 1



② x 1

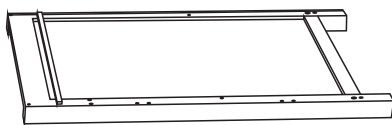

③ x 1

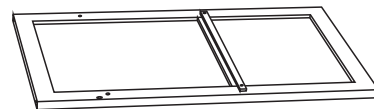

④ x 1

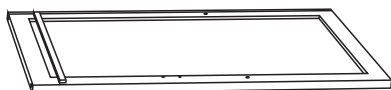

⑤ x 1

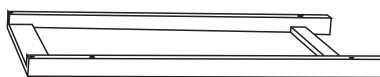

⑥ x 2



⑦ x 2

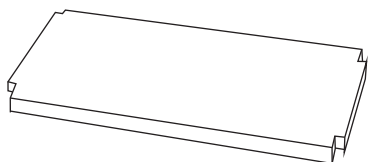

⑧ x 2

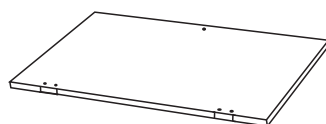

⑨ x 2



⑩ x 1



⑪ x 2

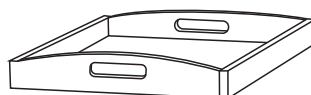

⑫ x 1

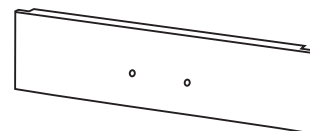

⑬ x 2

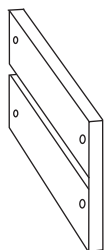

⑭ x 1

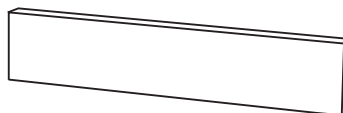

⑮ x 1

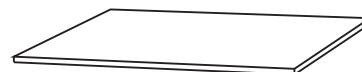

⑯ x 1

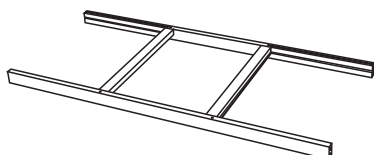

⑰ x 2

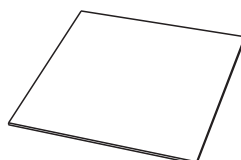

**A** x 12  
+1 (spare)

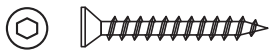

Ø5\*50mm

**B** x 16  
+1 (spare)



Ø3\*25mm

**C** x 2

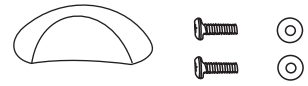

**D** x 2



**E** x 2  
+1 (spare)



Ø4\*16mm

**F** x 4

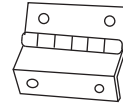

**G** x 16  
+1 (spare)

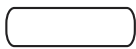

Ø6\*30mm

**H** x 2



**I** x 2

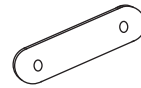

**J** x 24  
+1 (spare)



Ø3\*12mm

**K** x 12



**L** x 1



**G** x 4

**01**

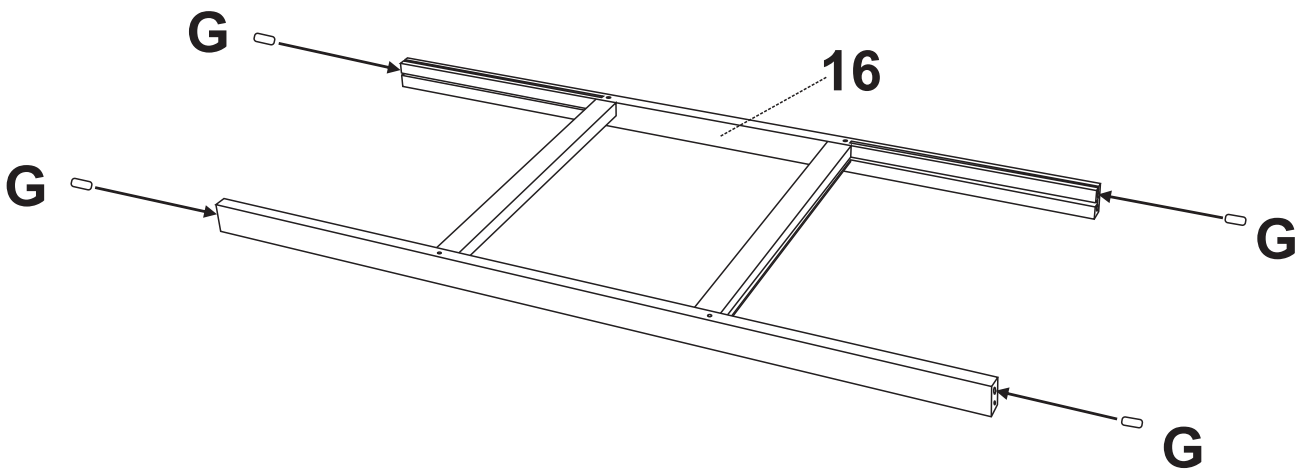

**A** x 4

**02**

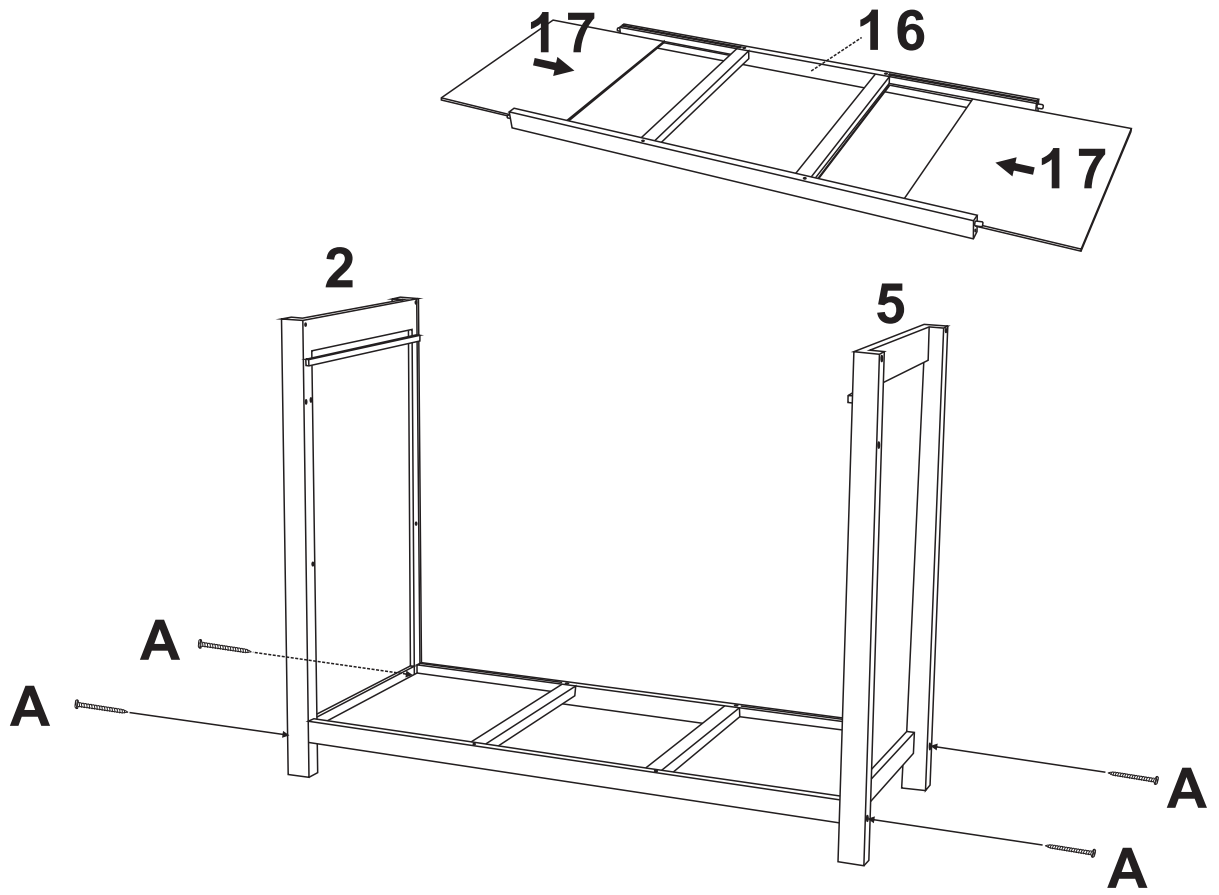

**A** x 2

**03**

**G** x 4

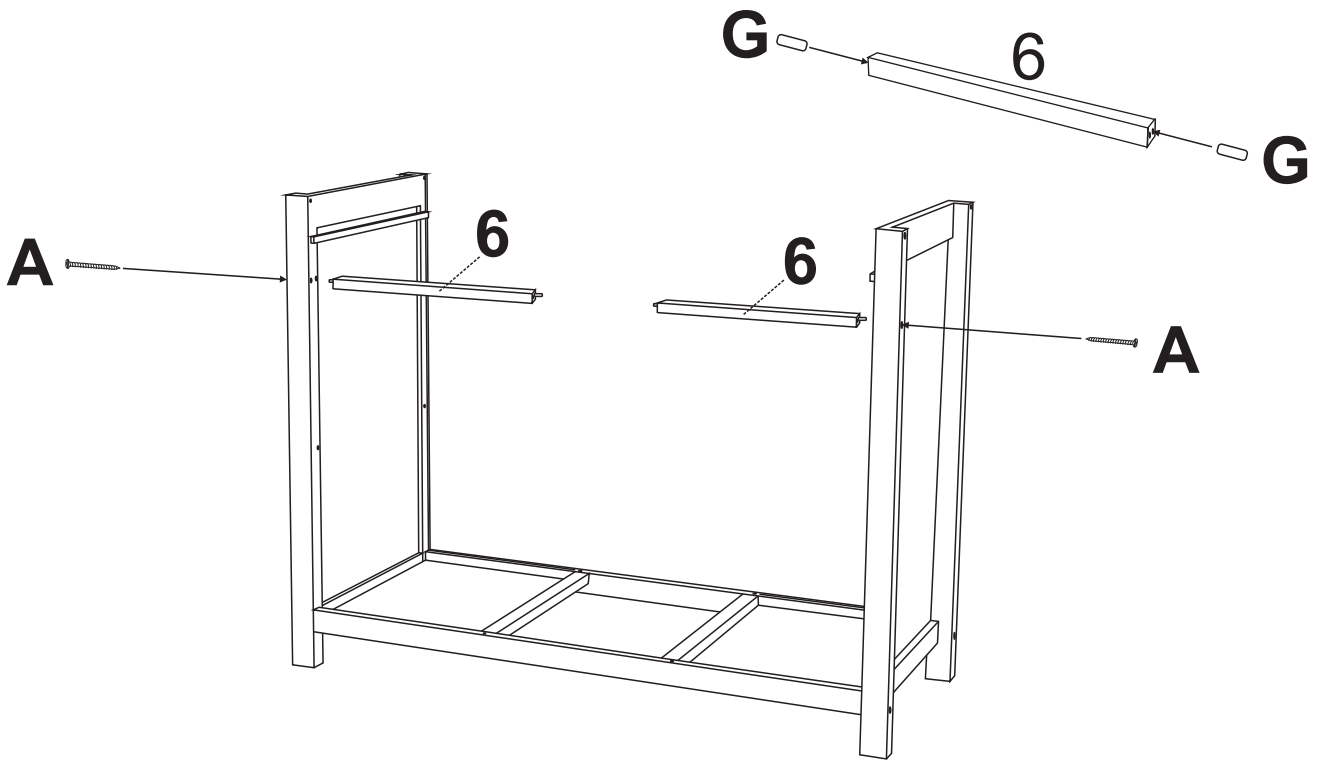

**G** x 8

**H** x 2

**J** x 4

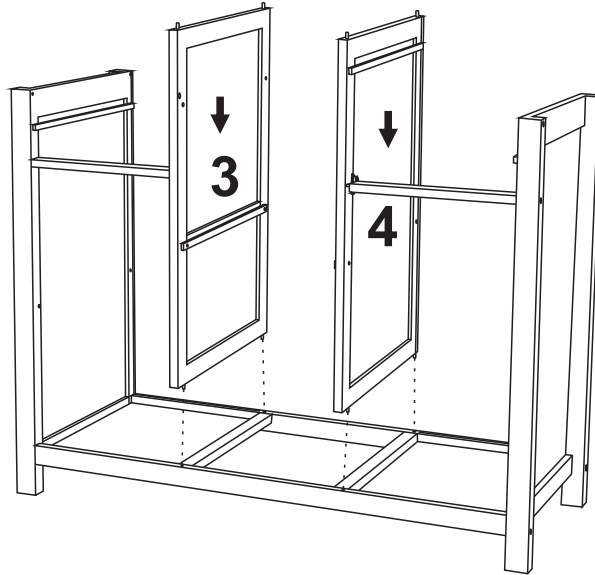
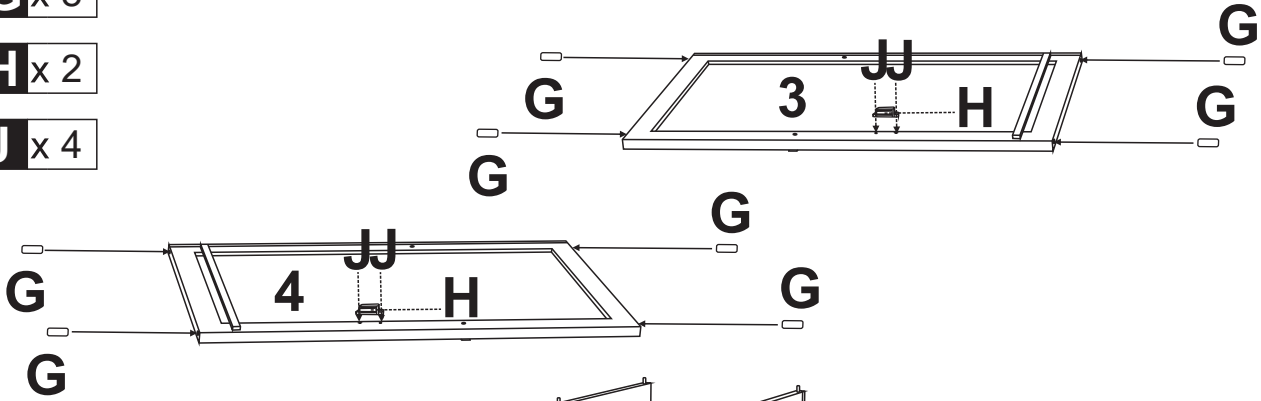

**A** x 2

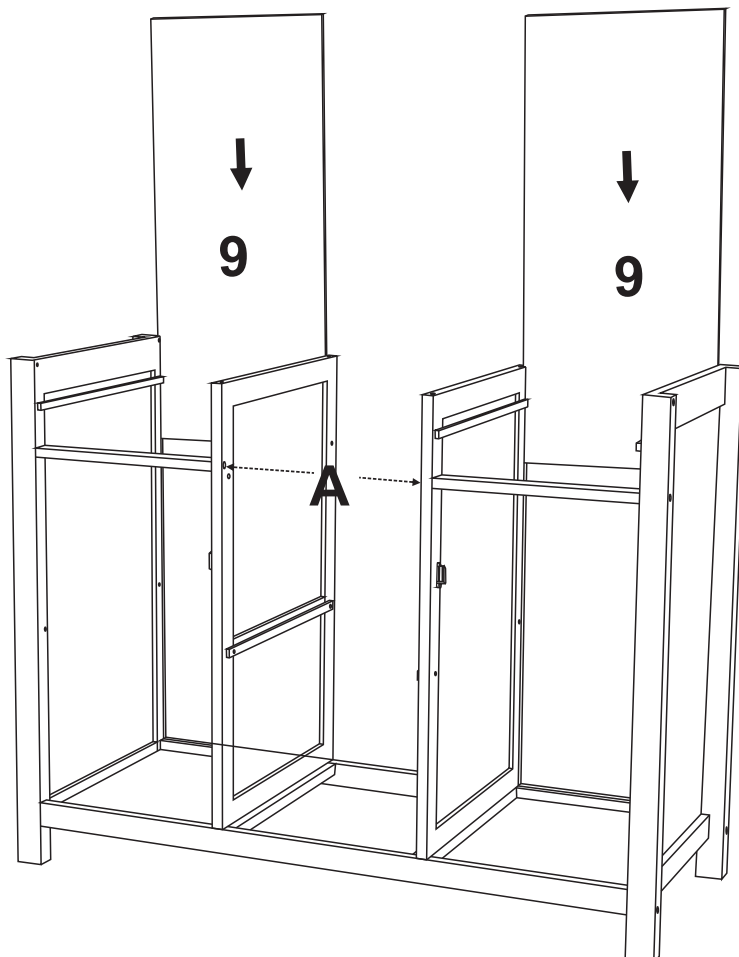

**A** x 4

**K** x 12

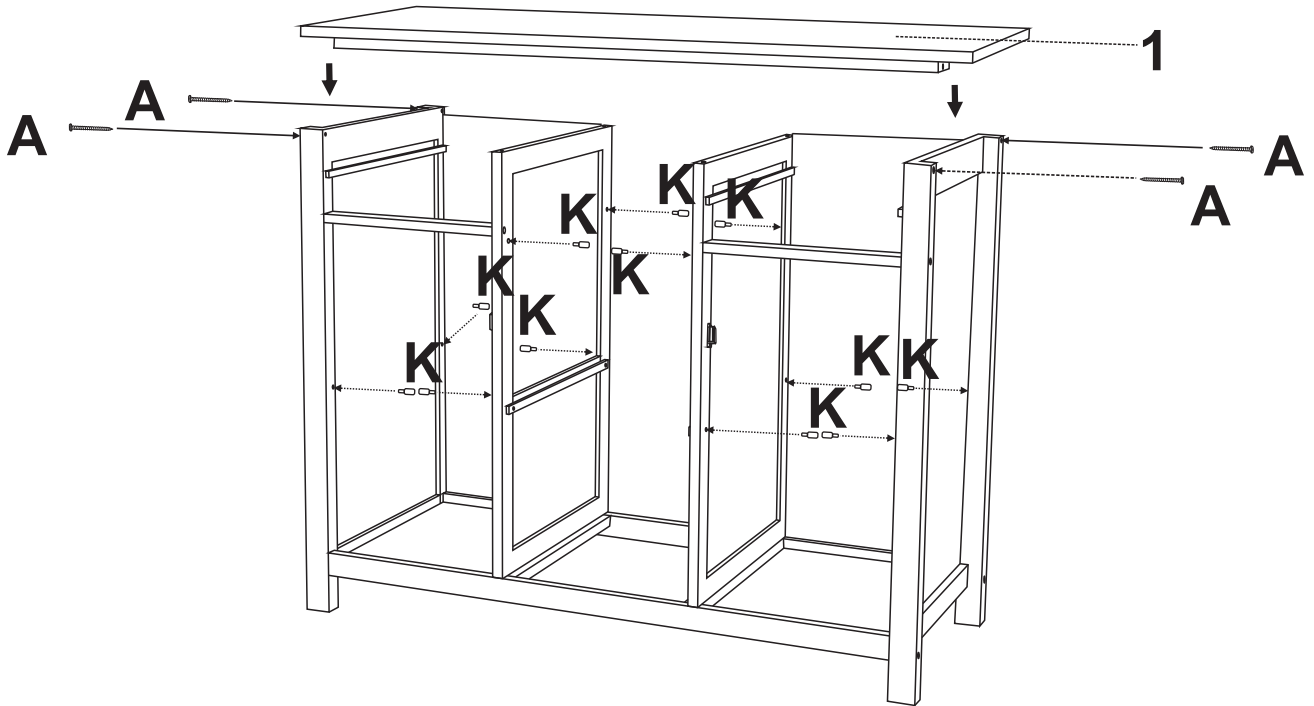

**D** x 2

**E** x 2

**F** x 4

**I** x 2

**J** x 20

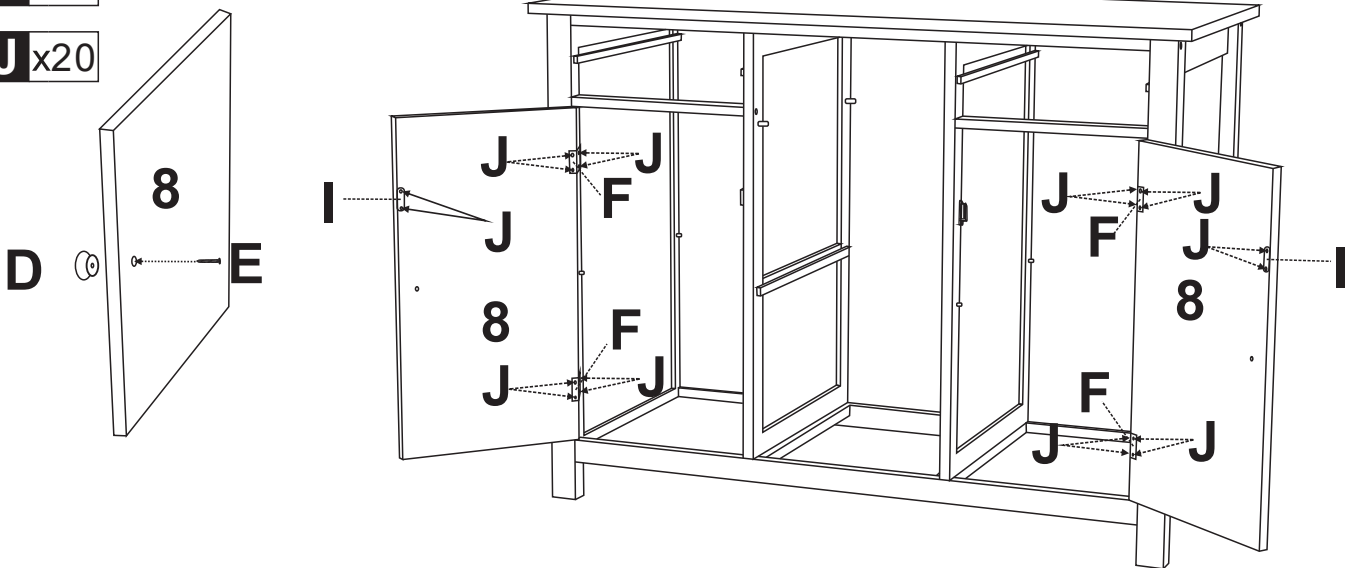

**B**x16

**C**x 2

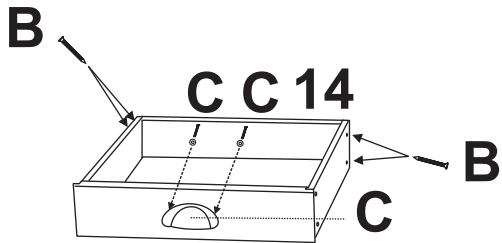
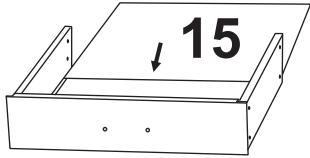
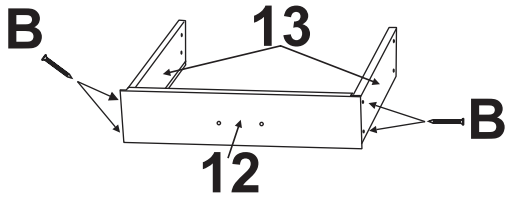

**X2**

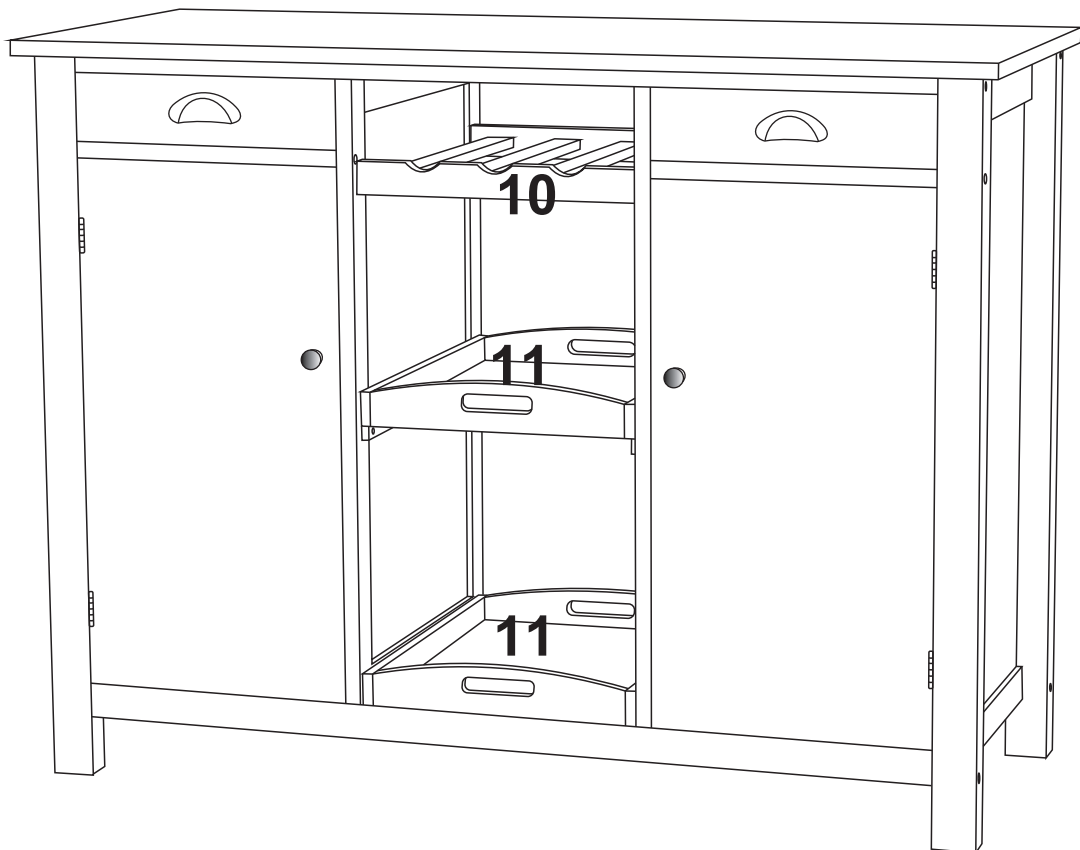
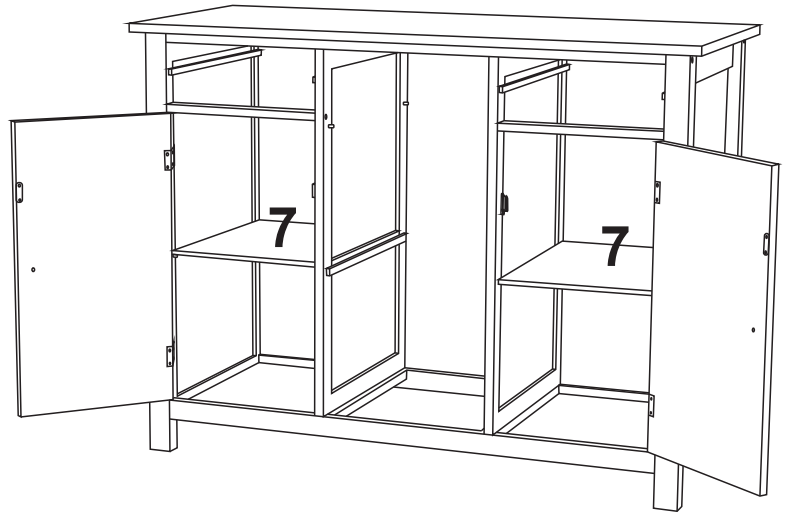



FR

**Pensez à  
donner ou recycler.**



Association

ou



Magasin

ou



Déchèterie

<https://quefairedemesdechets.fr>