

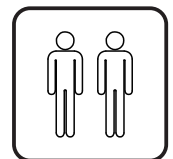

INcec035V01_GL

B72-028

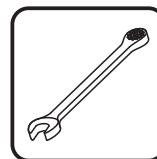
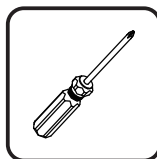
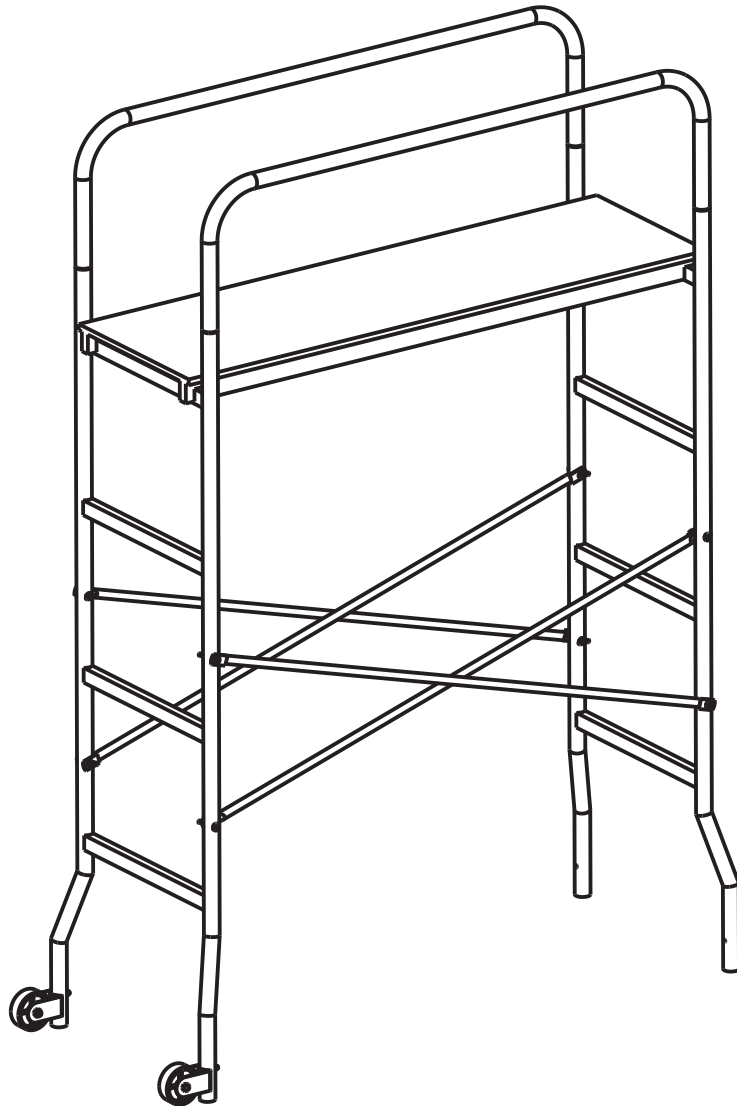

IMPORTANT, RETAIN FOR FUTURE REFERENCE: READ CAREFULLY

Tools Recommended

ASSEMBLY & INSTRUCTION MANUAL

PARTS

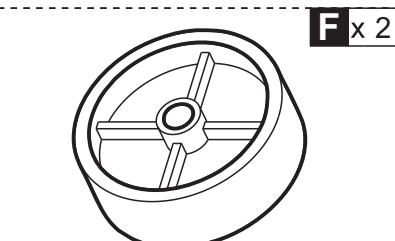
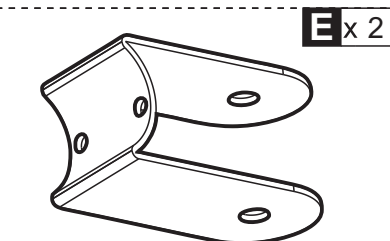
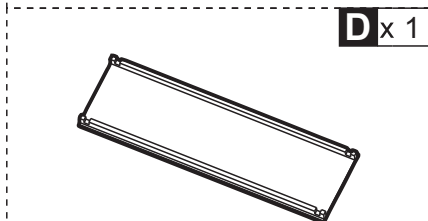
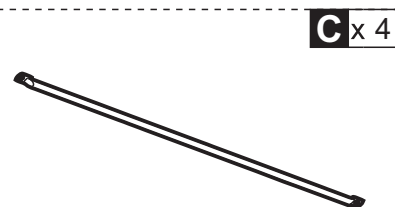
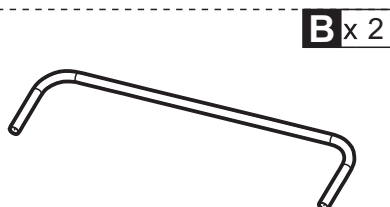
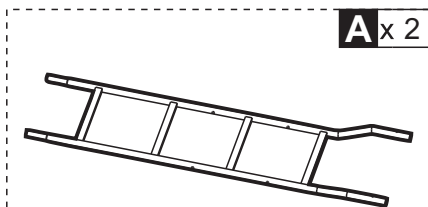

HARDWARE

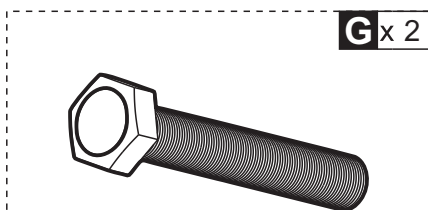

M8*50

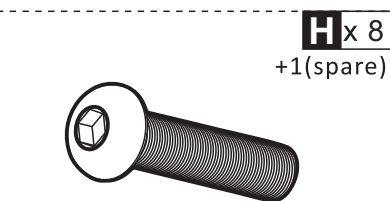

M8*35

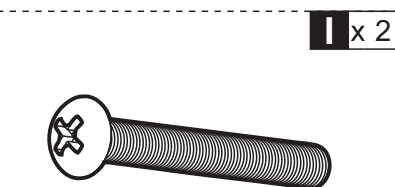

M5*40

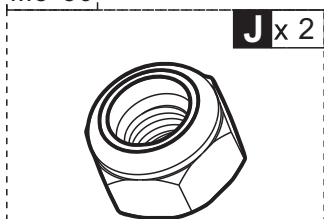

M8



M5

