

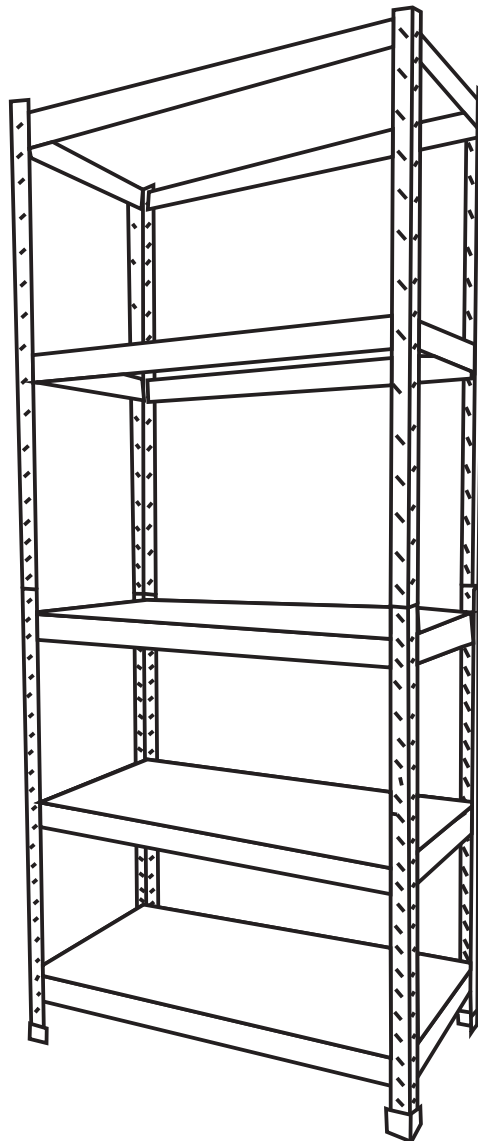

INcef009_CA

924-025



IMPORTANT, RETAIN FOR FUTURE REFERENCE: READ CAREFULLY

ASSEMBLY & INSTRUCTION MANUAL

PARTS

A x 8

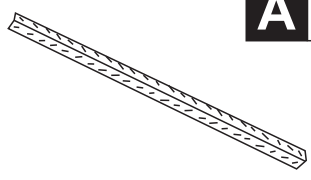

B x 10

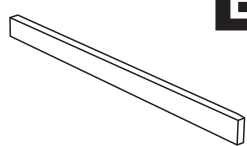

C x 10

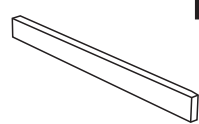

D x 5



E x 4

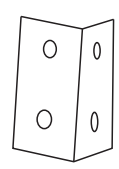

F x 4

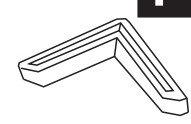

HARDWARE

G x 2
M4*50



H x 2
M4



I x 2

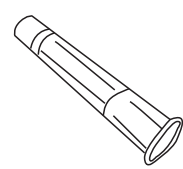

01

A x 1

F x 1



A

F



x4

02

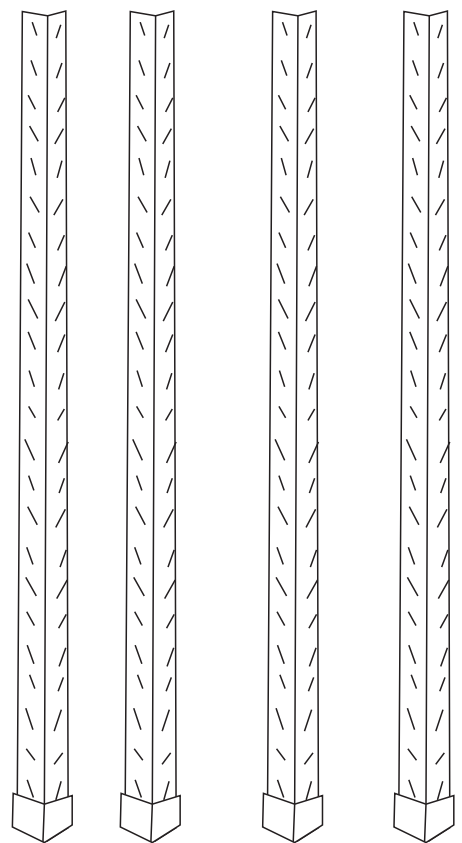

B x 2

C x 2

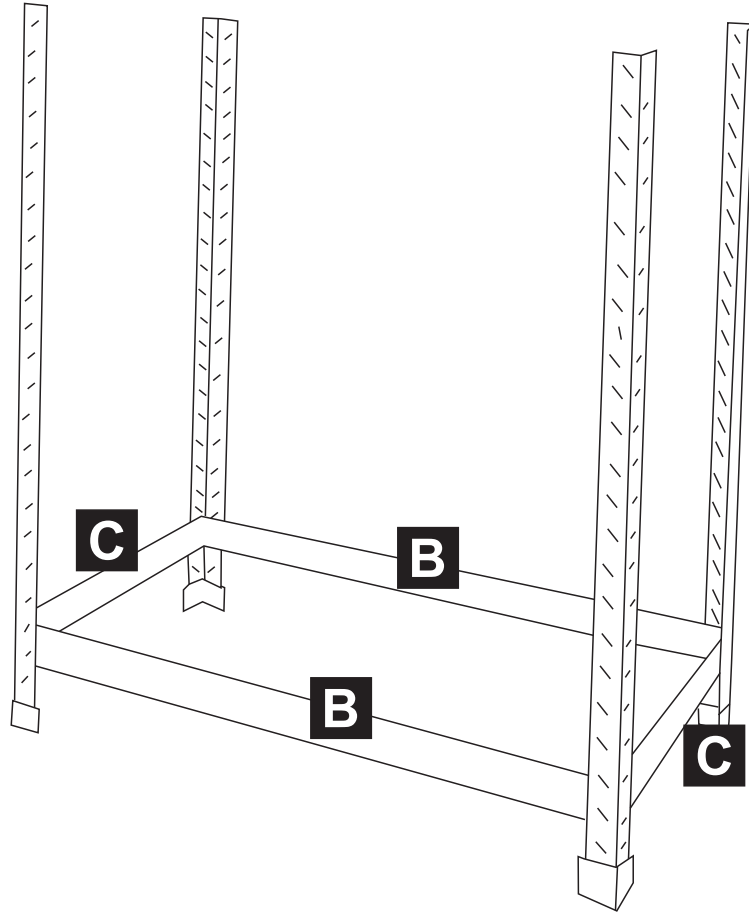

E x 4

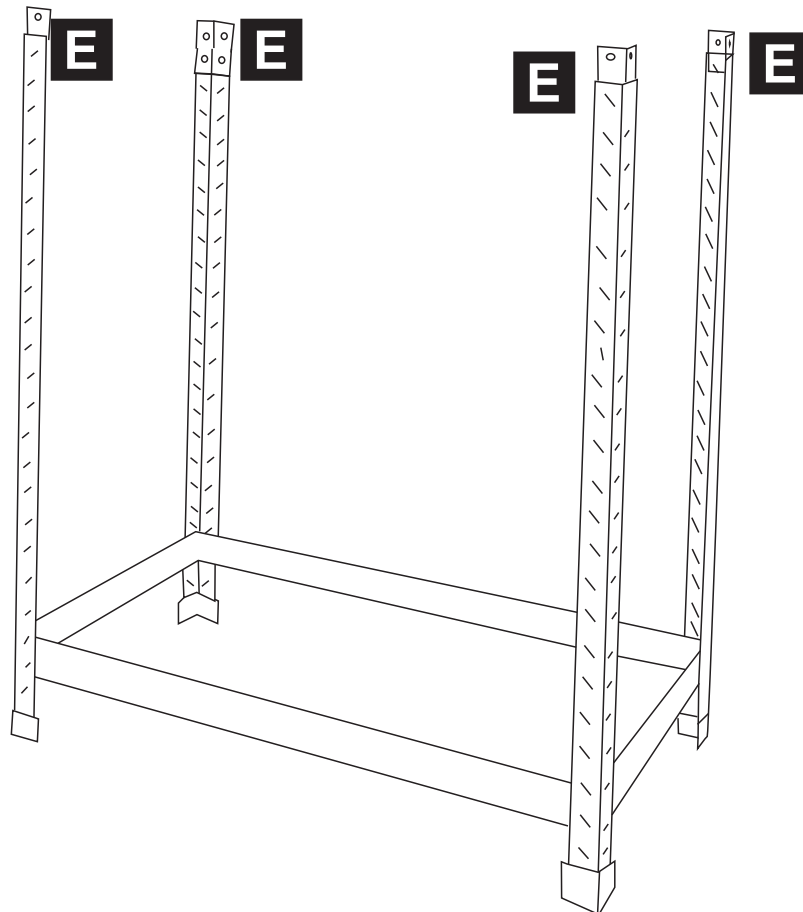

A x 4

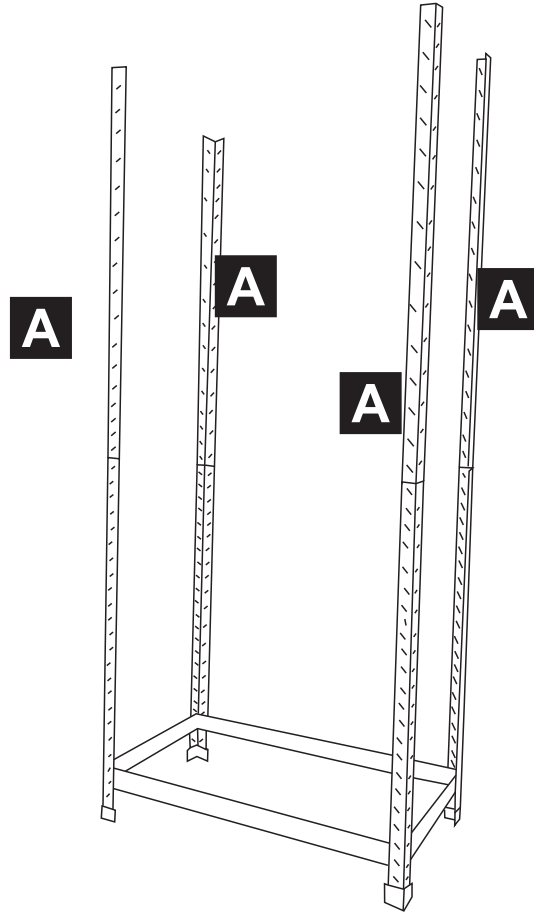

B x 2

C x 2

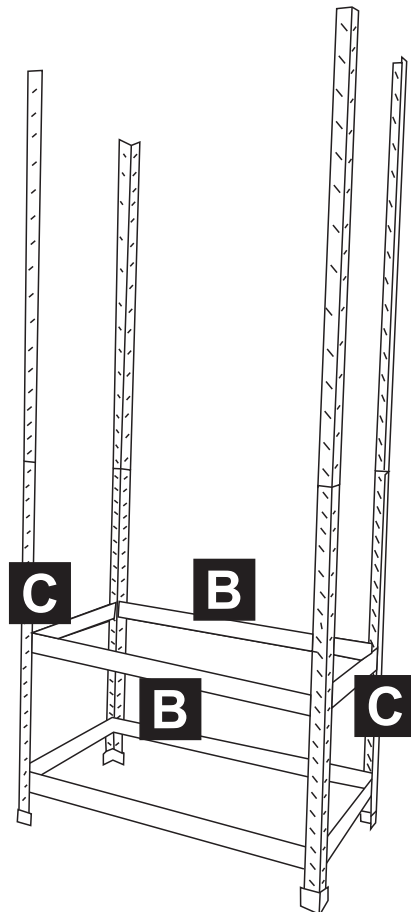

B x 2

C x 2

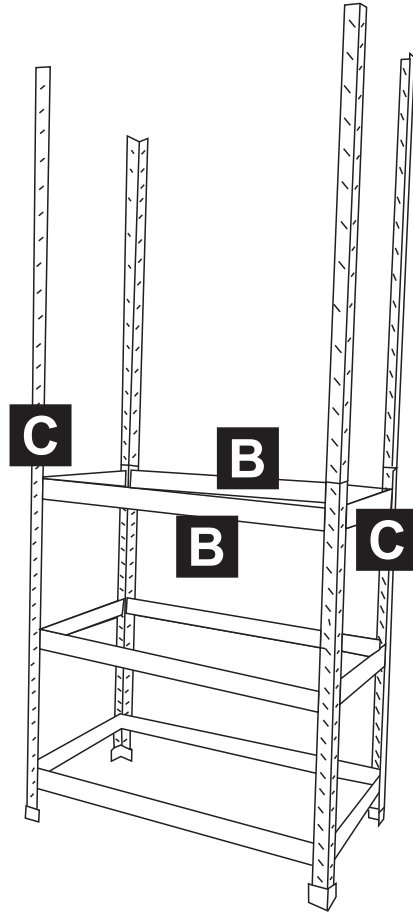

B x 2

C x 2

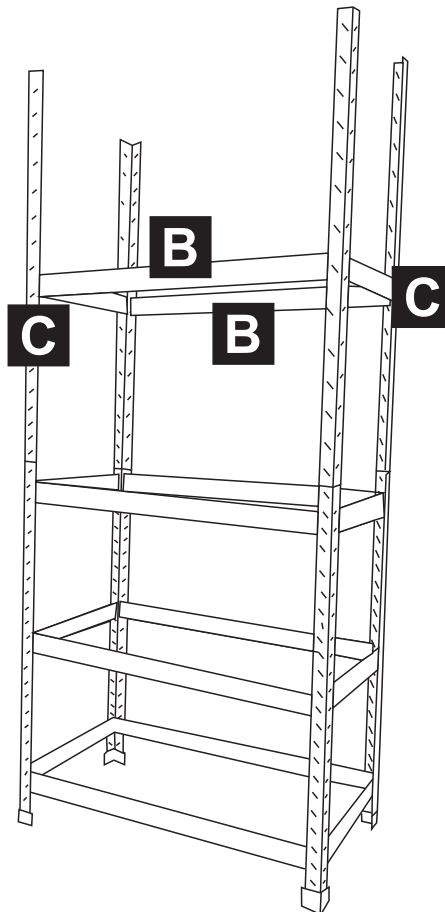

B x 2

C x 2

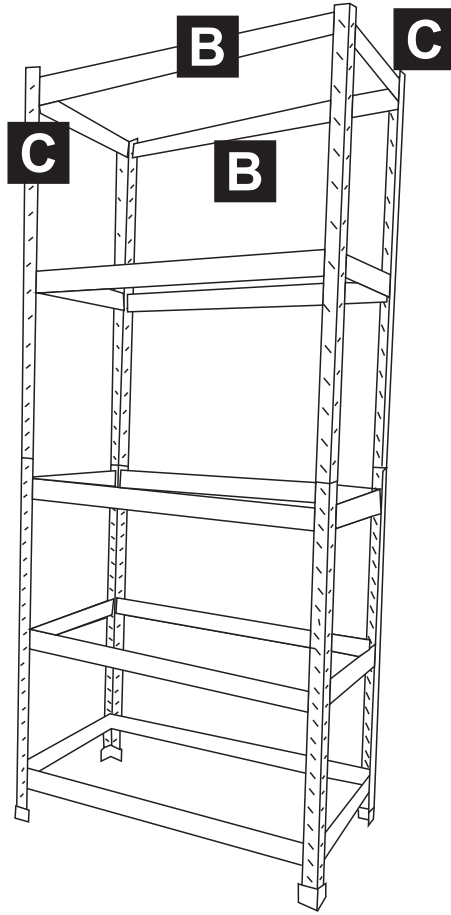

D x 5

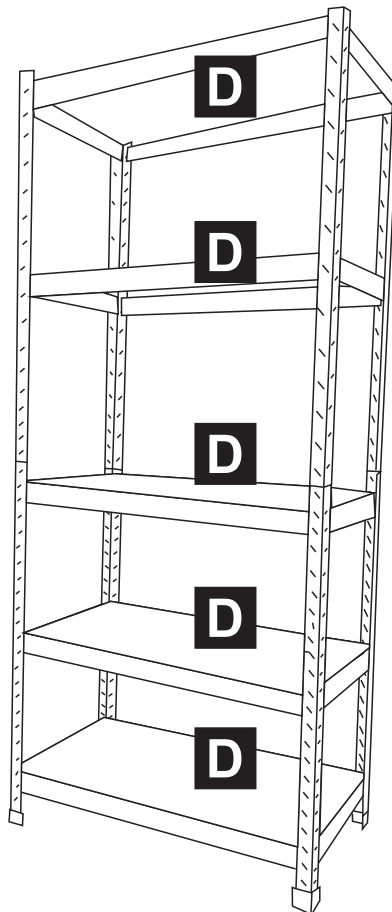

G x 2
M4*50

H x 2
M4

I x 2

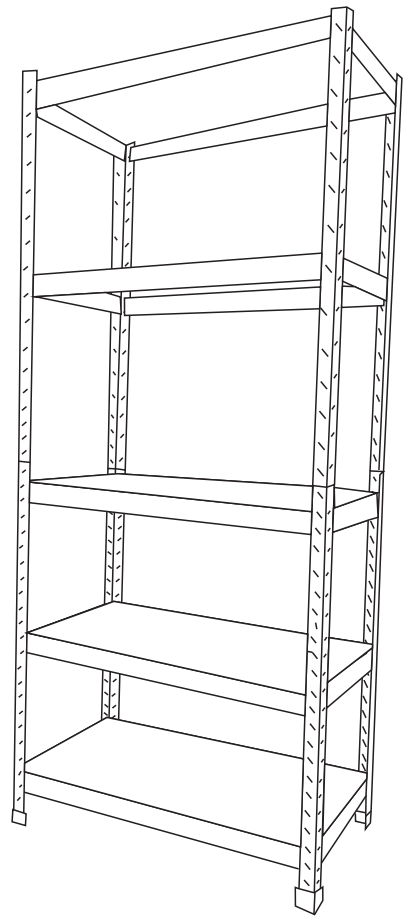
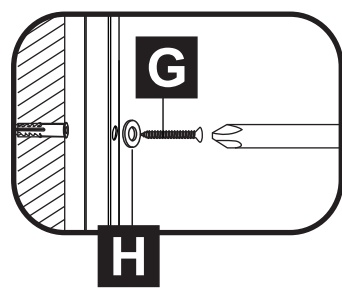
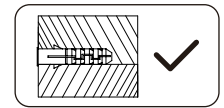
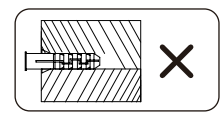
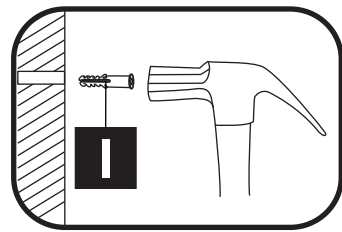
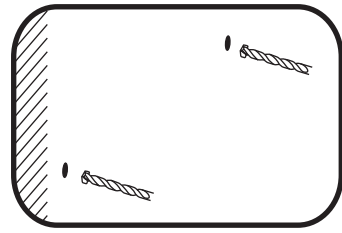
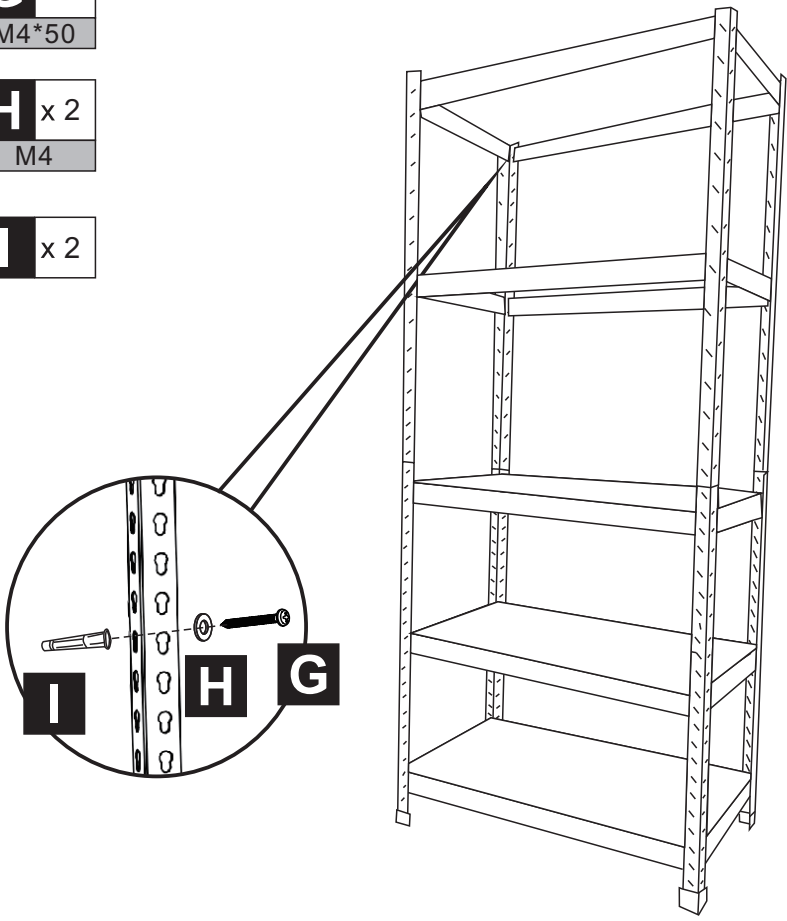

US



001-877-644-9366
customerservice@aosom.com

CA



001-855-537-6088
customerservice@aosom.ca

UK



0044-800-240-4004
enquiries@mhstar.co.uk

DE



0049-(0)40-88307530
service@aosom.de

FR



0033-1-84166106
contact@aosom.fr

ES



0034-931294512
atencioncliente@aosom.es

IT



0039-0249471447
clienti@aosom.it