

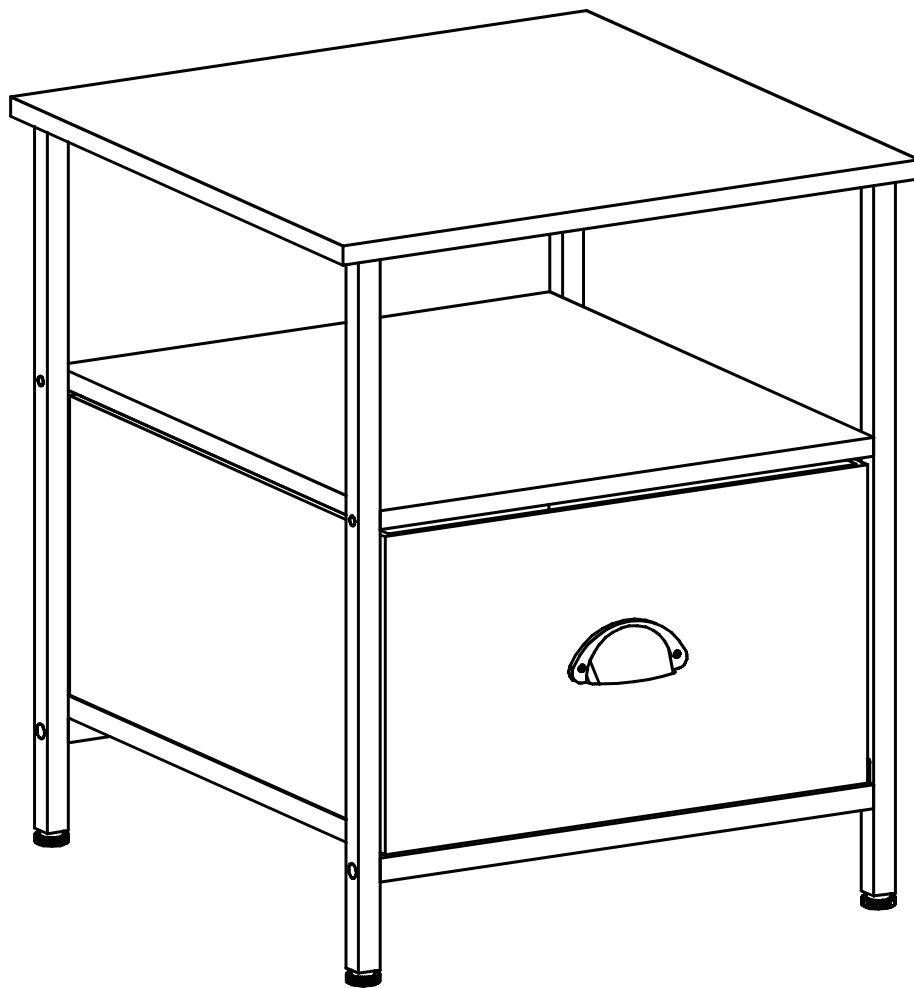

INcgb154_GL

839-170



IMPORTANT, RETAIN FOR FUTURE REFERENCE: READ CAREFULLY

ASSEMBLY & INSTRUCTION MANUAL

PARTS

1 x01

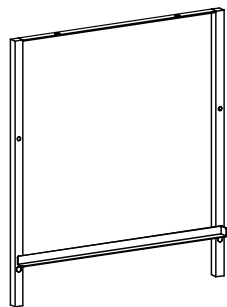

2 x01

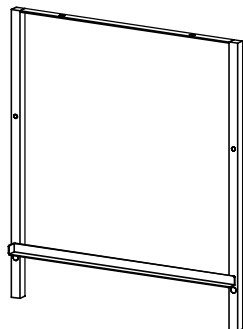

3 x02



4 x01

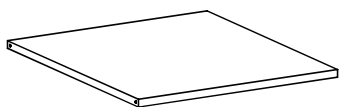

5 x01

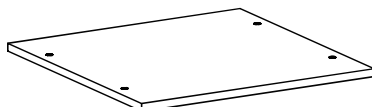

6 x01

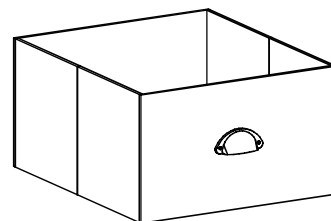

7 x04

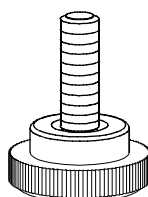

A x04
ST 5x40

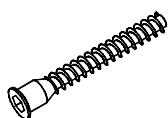

B x04
M6x30

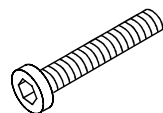

C x04
M6x8



D x01

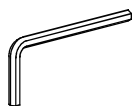

E x01

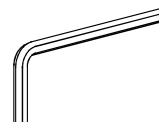

HARDWARE

⑥ x01

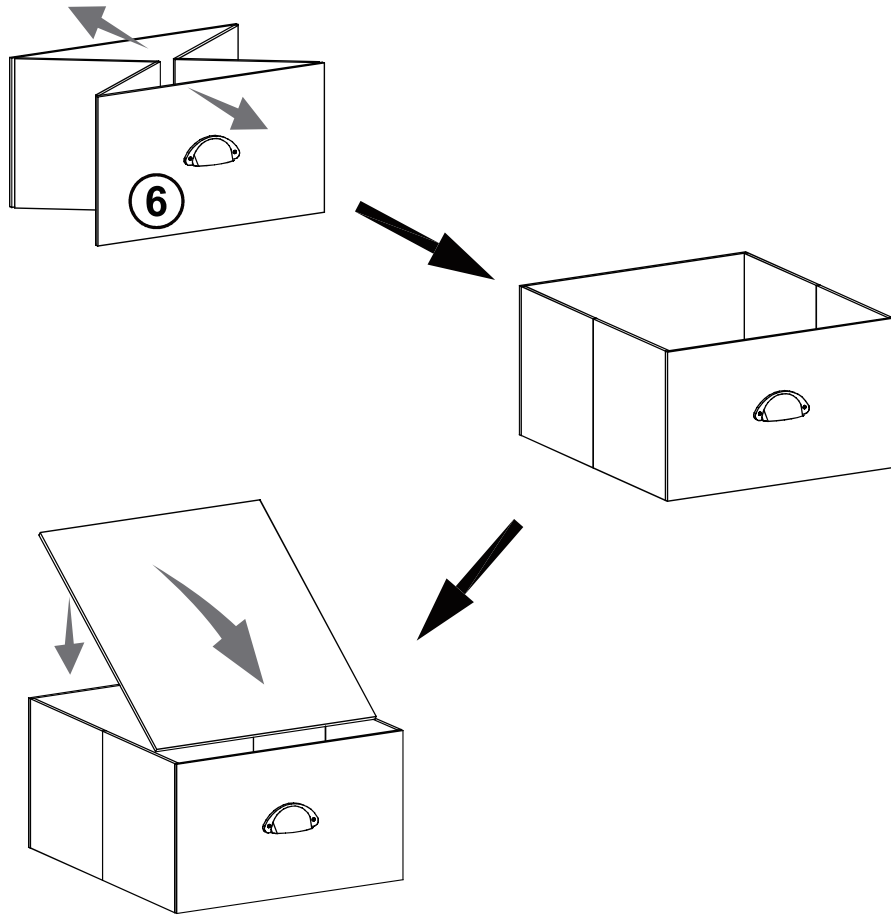

① x01

② x01

⑦ x04

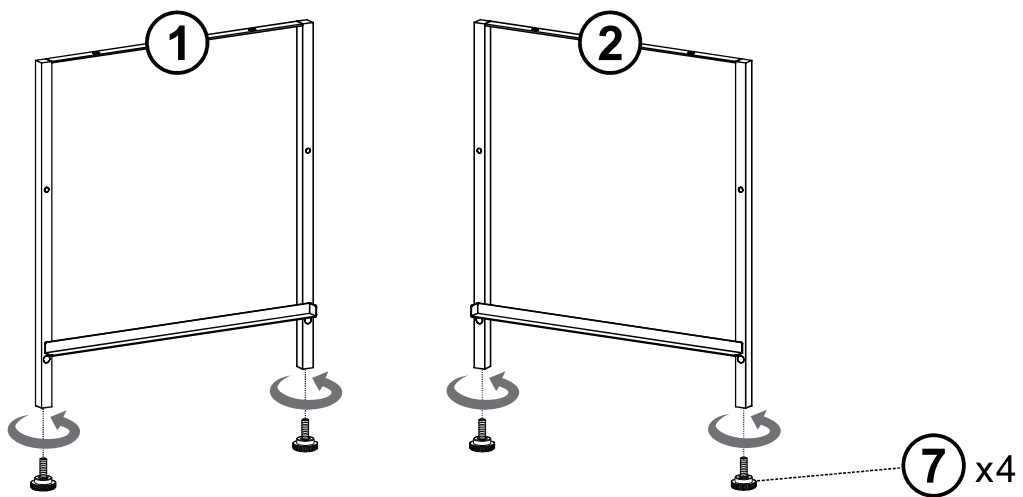

③ x02

④ x01

A x04

B x04

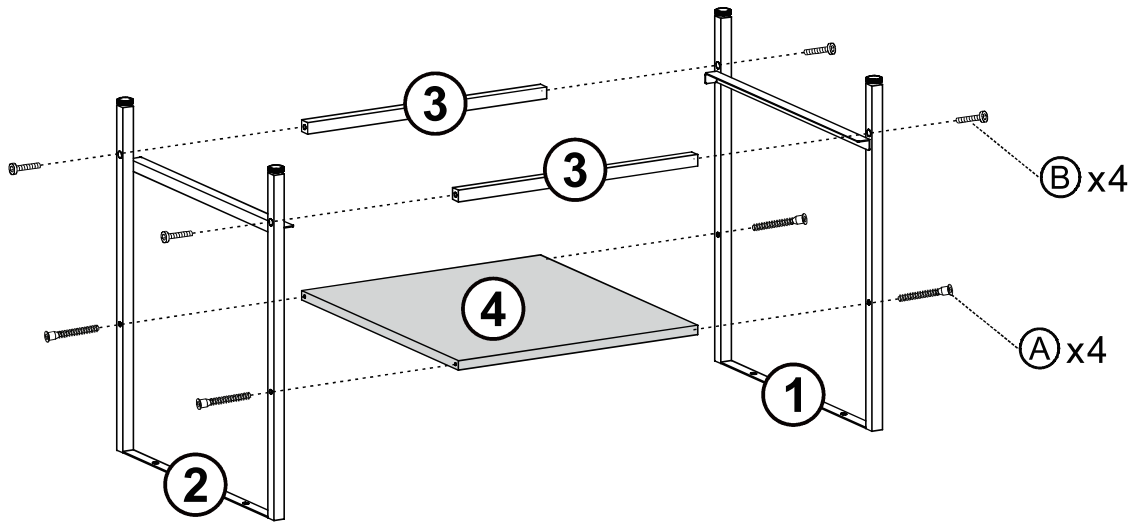

⑤ x01

C x04

