

**EN\_IMPORTANT, RETAIN FOR FUTURE REFERENCE: READ CAREFULLY.**

**FR\_IMPORTANT: A LIRE ATTENTIVEMENT ET À CONSERVER POUR CONSULTATION  
ULTÉRIEURE.**

**ES\_IMPORTANTE, LEA Y GUARDE PARA FUTURAS REFERENCIAS.**

**DE\_WICHTIG! SORGFÄLTIG LESEN UND FÜR SPÄTER NACHSCHLAGEN AUFBEWAHREN.**

**IT\_IMPORTANTE! CONSERVARE IL PRESENTE MANUALE PER FUTURO RIFERIMENTO E  
LEggerlo ATTENTAMENTE.**



## **Important Safety Information**

Fuel is flammable. Failure to follow the safety information can result in property damage or serious burns.

Do not store or use gasoline or other flammable materials near the unit. Vapors or leaks from these types of items could travel to sources of flame or heat and increase the risk of fire or explosion.

Do not attempt to refuel a unit that is already burning. Pouring any kind of fuel on a fire or on a hot surface can cause flare-ups or flashbacks that could burn someone. Make sure the fire is out and allow the unit to cool for 30 minutes before refueling.

Never burn trash, paper, wood or any other fuel in the unit.

Do not try to combine fuel from different cans.

Do not pour or scoop fuel out of the can into any other container or try to combine fuel from different cans. Never add fuel to a fire or pour on hot surfaces, doing so could cause flare-ups or flashbacks that could burn someone.

Never burn fuel cans outside the designated burn area in the metal firebox.

The fire bowl should not be operated by anyone below age 18. Keep away from children and pets.

Do not use it in the tents or boats and/or on recreational vehicles.

Make sure the fire bowl is placed on a flat and level surface. Otherwise, the unit could tip easily and start a fire that could damage property or cause serious injury. Do not place fire bowl in an area with lots of traffic, such as a hallway or entryway.

Never leave a burning fire unattended, especially around children or pets.

Do not wear flammable or loose clothing when operating the fire bowl.

Never touch any metal surfaces during or immediately after burning fuel. They will be extremely HOT. Allow surfaces to cool for 30 minutes before touching, changing cans or moving the unit.

## Package Contents

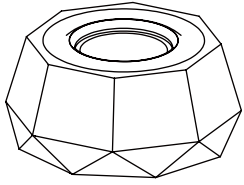

fire bowl  
body (1 pc)

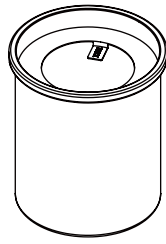

fuel can (1 set)

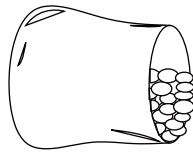

glass beads  
(0.55 lbs)

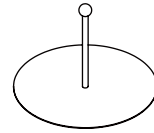

extinguishing  
cover (1 pc)



can opener (1 pc)

## Assembly

1. Carefully unpack all parts from the box, compare parts with package content listed above, make sure all parts are present before beginning assembly of product. If any part is missing or damaged, do not attempt to assemble the product. Call customer service.
2. Place the fuel can into the fire bowl carefully, make the fuel can leveler (See Figure 1).
3. Put the glass beads evenly onto fire bowl (See Figure 2).

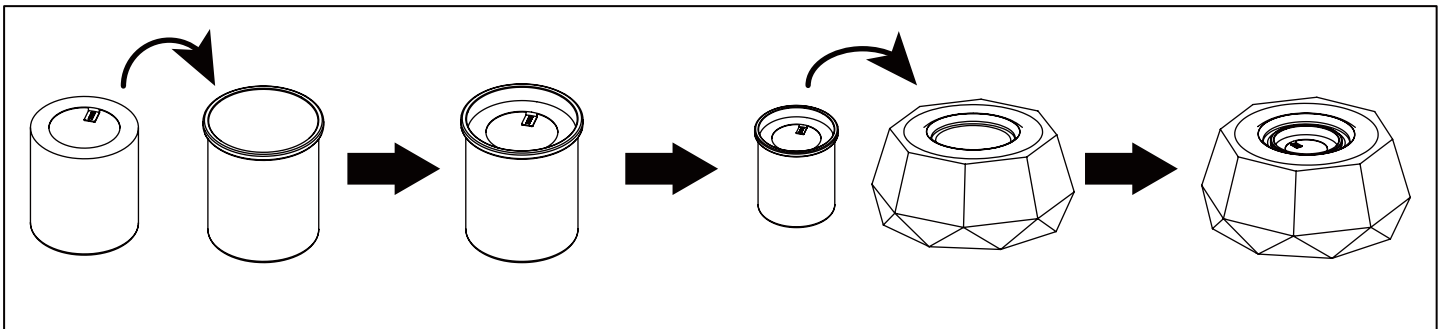

Figure 1

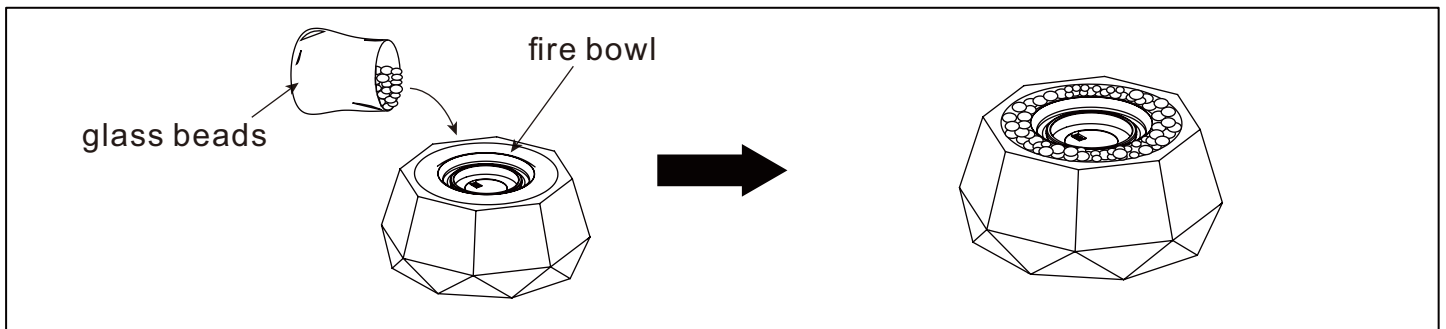

Figure 2

## Before lighting the fire bowl

The fuel can is empty, it is recommended to fill bio-ethanol into the can on the initial use. After the fuel is used up, the fuel can be filled or refueled with bio-ethanol or gel fuel after it is cooled COMPLETELY.

NOTE: DO NOT exceed the "max" volume level while refueling the fuel can (see Figure 3).

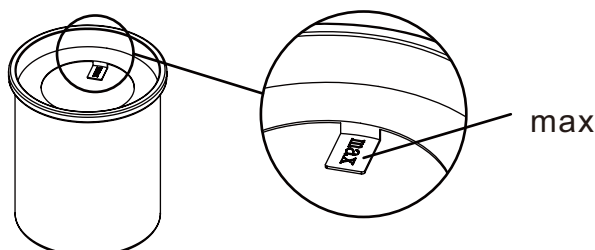

Figure 3

## Lighting the fire bowl

1. Use a long match or extended butane lighter to ignite fuel. If the fire bowl cannot ignite, repeat the step (See Figure 4).

### NOTE:

- (1). Each can burns approx. 70 ~ 90 minutes, on condition that the alcohol content meets or exceeds 90%.
- (2). On the initial use, flames are short. Keep burning 5 minutes, flames will reach out to a desirable height.
- (3). During the initial burn, you may smell a slight odor. The odor is temporary and will be absent on following burns.
- (4). Do not use the short butane lighter to ignite the unit to prevent from the scalding.
- (5). During the burning, the outer wall of fire bowl will become extremely HOT. DO NOT touch or move the unit, DO NOT change the cans. Wait 30 minutes until it's cooled COMPLETELY.

## Extinguishing the fire bowl

1. Place the extinguishing cover onto fuel can until NO flames are present (See Figure 5).

### NOTE:

- (1). DO NOT blow out the flames using mouth or electrical fan.
- (2). DO NOT douse the flames using the water.
- (3). After the burning, the outer wall of fire bowl is still extremely HOT. DO NOT touch or move the unit, DO NOT change the cans. Wait 30 minute until it's cooled COMPLETELY.

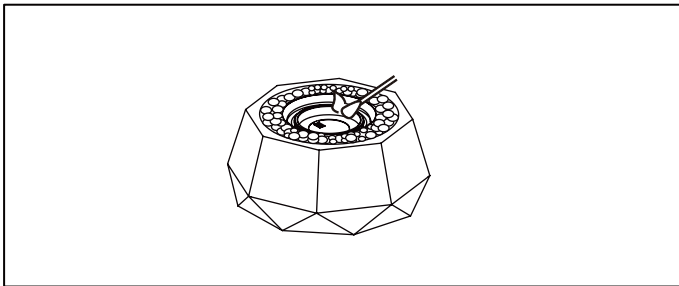

Figure 4

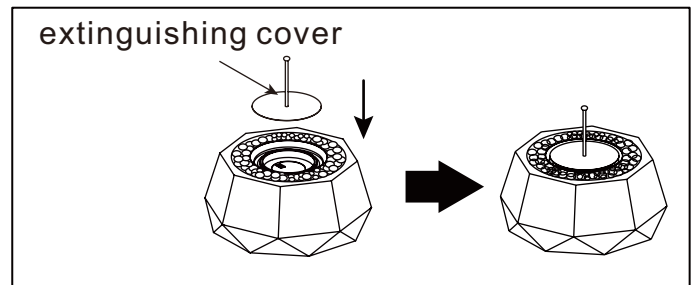

Figure 5

## Optional Fuel Can

This fire bowl is also adapted to the gel fuel can as specified in the diagram (See Figure 6). DO NOT USE THE CAN BEYOND THIS DIMENSION STANDARD. This gel fuel can is already filled with gel fuel and disposable, you can purchase it from the marketplace.

1. Install the fuel can and glass beads (See Figure 1 ~ 2).
2. Open the fuel can with the can opener, follow the same procedures of "Lighting the fire bowl" and "Extinguishing the fire bowl" to operate the fire bowl.

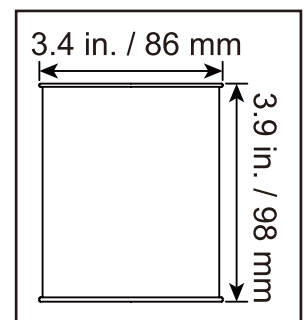

Figure 6

## First Aid

Avoid contact with eyes, mucous membranes or prolonged contact with skin. May irritate eyes.

If fuel gets in eyes, flush with water for 15 minutes, get medical attention. If ingested, do not induce vomiting, call poison control center or a doctor.

## **Hazard statements**

- Highly flammable liquid and vapor.
- Causes serious eye irritation.
- May cause drowsiness or dizziness.
- At least 70.0% by mass of the contents are flammable.
- Keep out of the reach of children under 18.

## **Precautionary statements**

- If medical advice is needed, have product container or label at hand.
- Keep out of reach of children.
- Read label before use. NEVER POUR THE FUEL IN THE CAN INTO ANY OTHER CONTAINER.
- Keep away from heat/sparks/open flames/hot surfaces. No smoking.
- Use explosion-proof electrical/ventilating/lighting/equipment.
- Avoid breathing dust/fume/gas/mist/vapors/spray.
- Wear protective gloves/protective clothing/eye protection/face protection.
- Ground/bond container and receiving equipment.
- Keep container tightly closed.
- Use only non-sparking tools.
- Take precautionary measures against static discharge.
- Wash thoroughly after handling.
- Use outdoors or indoors in a well-ventilated area.
- IF ON SKIN (or hair): Remove/Take off immediately all contaminated clothing. Rinse skin with water/shower.
- IF IN EYES: Rinse cautiously with water for several minutes. Remove contact lenses, if present and easy to do. Continue rinsing.
- IF INHALED: Remove victim to fresh air and keep at rest in a position comfortable for breathing.
- Call a POISON CENTER or doctor/physician if you feel unwell.
- If eye irritation persists: Get medical advice/attention.
- In case of fire: Use for extinction: CO<sub>2</sub>, powder or water spray.
- Store locked up.
- Store in a well-ventilated place. Keep container tightly closed. Keep container cool.
- Dispose of contents/container in accordance with local/regional/national/international law or regulations.

## **Customer Service Before Return:**

If part missing or damaged, or you need help with assembly, please do not hesitate to contact us.