

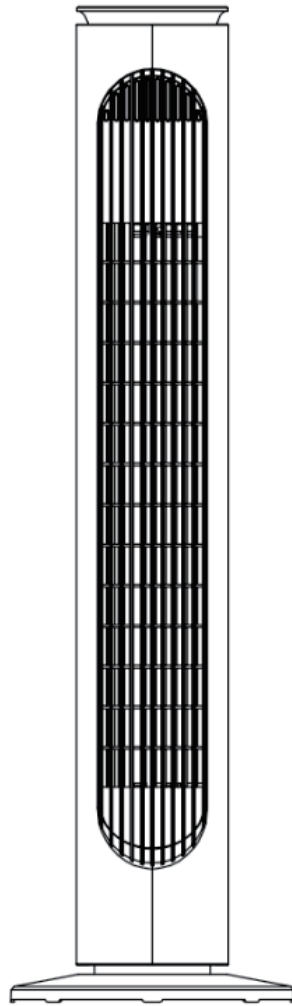

INcjh008V01_UK

824-015V70



220-240V~50-60Hz 45W



IMPORTANT, RETAIN FOR FUTURE REFERENCE: READ CAREFULLY

ASSEMBLY & INSTRUCTION MANUAL

READ CAREFULLY BEFORE ATTEMPTING TO ASSEMBLE, INSTALL, OPERATE OR MAINTAIN THE PRODUCT DESCRIBED. PROTECT YOURSELF AND OTHER BY OBSERVING ALL SAFETY INFORMATION. FAILURE TO COMPLY WITH INSTRUCTIONS COULD RESULT IN PERSONAL INJURY AND/OR PROPERTY DAMAGE!

IMPORTANT SAFETY INFORMATION

1. Read all instructions carefully before using the FAN.
2. Use this FAN only as described in this manual. Any other use not recommended by the manufacturer may cause fire, electrical shock, or injury to persons.
3. Remove the package and ensure that the FAN is undamaged. In case of doubt do not use FAN and contact with your supplier.
4. Do not let children play parts of package.
5. Before use the FAN, check if the voltage marked on the rating label corresponds to the mains in your home.
6. Extreme caution is necessary when the FAN is used by or near children or Invalids and whenever the FAN is left operating unattended.
7. Avoid using extension cord as the extension cord may

overheat and cause a risk of fire.

8. Do not pull the power cord to disconnect with power source. Always grasp the plug to pull out.
9. Do not insert any objects into the FAN as it may cause an electric shock or injure or damage to the FAN. Do not block or tamper with the FAN in any manner while it is in operation.
10. Do not leave the FAN unattended. Always unplug FAN when not in use.
11. This FAN is not intended for use in wet or damp locations. Never locate a FAN where it may fall into a bathtub or other water container.
12. Do not use FAN outdoors.
13. Disconnect the fan from the mains power when not in use, and before servicing or performing any maintenance.

WARNING : *The Main Power Switch and the On/Off switch should not be used as the sole means of disconnecting power. Always unplug the power cord before servicing or moving the unit.*

14. Always disconnect the fan from the power supply when moving it from one location to another.
15. Keep the fan clean and maintain in good condition (use an authorized service agent).
16. Use recommended parts only (non genuine parts may be dangerous, and will invalidate your warranty).
17. When not in use store in a safe, dry, childproof location.
18. This appliance can be used by children aged from 8 years and above and persons with reduced physical, sensory or mental capabilities or lack of experience and knowledge if they have been given supervision or instruction concerning use of the appliance in a safe way and understand the hazards involved. Children shall not play with the appliance. Cleaning and user

maintenance shall not be made by children without supervision.

WARNING : *To avoid danger of electric shock, unplug from outlet when not in use and before cleaning. If the supply cord is damaged, it must be replaced by the manufactory or it's service agent or a similarity qualified person in order to avoid a hazard.*

PARTS NAME

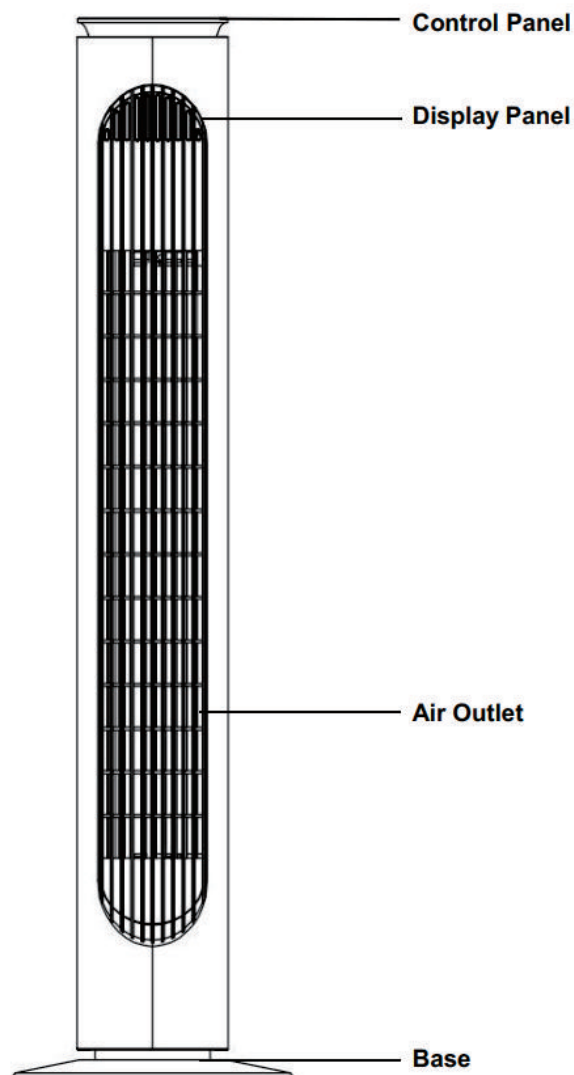

ASSEMBLY

The base of the tower fan comes in two parts, which fit around the oscillation base. Both parts fit easily together.

1. First attach the front half of the base, aligning the holes in base with the screw hole in the oscillation base, and leading the power cord up the base.
2. Then snap the back half of the base to the front half and secure with the plastic screw nut (supplied), wise it clockwise. (Figure1)

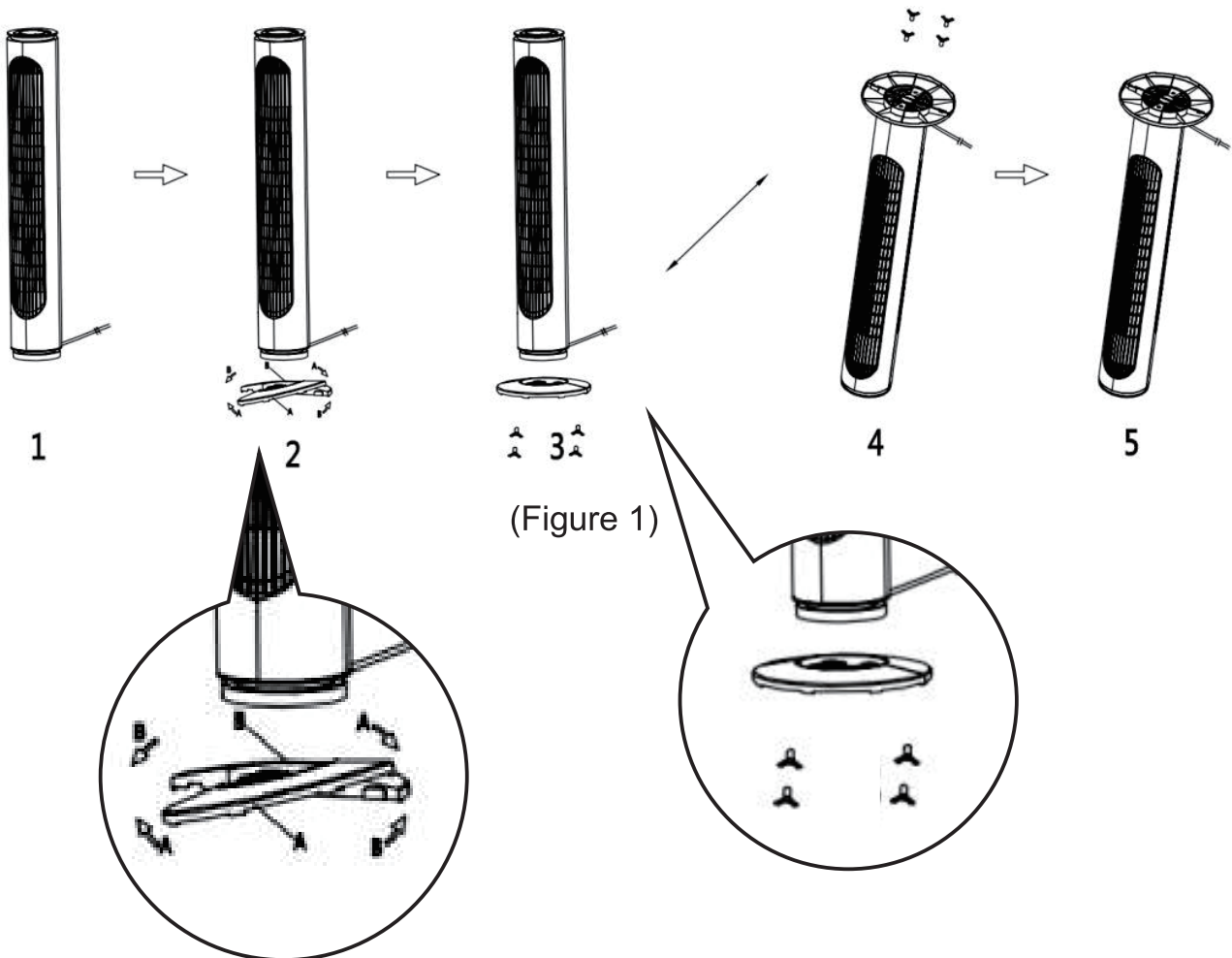

REMOTE CONTROL

1. Install one "CR2025" (included) battery.
2. The Remote Control Power button is labeled as such. All the functions performed with the Remote Control work identically to the Manual Controls. (FIGURE 2).

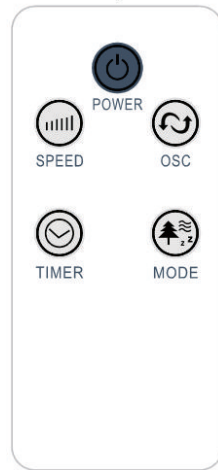



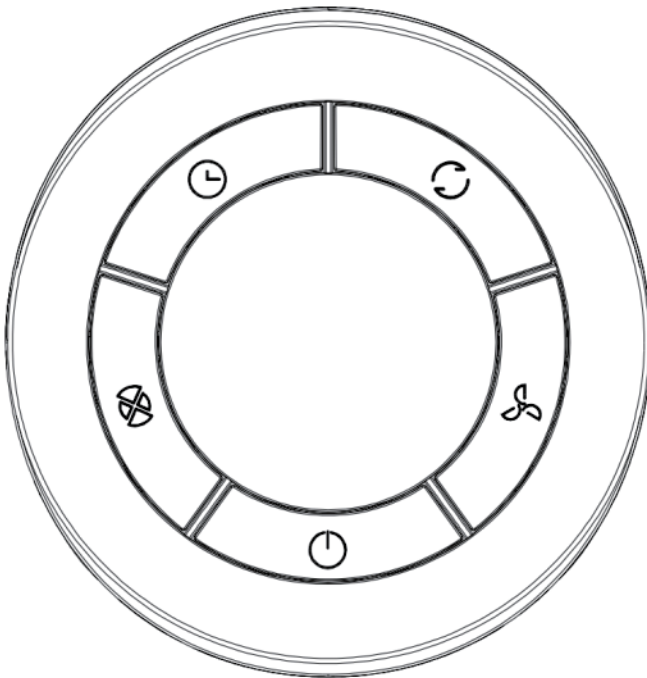

(FIGURE 2)

OPERATION



The FAN may be operated by the manual controls located on the FAN (as shown in FIGURE 3) or by your remote control (shown in FIGURE 2) .



(FIGURE 3)

1. Place the FAN on a stable flat surface. Plug the cord set into a 220-240V~ electrical outlet.
2. **POWER** : Turn the FAN on by pressing the ‘’, button; Turn the FAN off by pressing the ‘’, button again.
3. **SPEED** : You can adjust the fan speed to the desired level:

low (), medium (), or high () by pressing '  '. The speed setting is displayed on the LED panel (shown in FIGURE 4) .



4. **MODE**  : Pressing the '  ' button will set the FAN into NORMAL mode, NATURAL mode , SLEEP mode.(shown in FIGURE 4)

- NORMAL Mode  : fan will start work at any speed you set up.

- NATURAL Mode  :fan will start work at high speed(15s), middle speed(15s) and low speed(15s), it works as per this recycle.

- SLEEP Mode  : if you set the mode at high speed, fan will work at high speed at 30 mins, then transfer to middle speed at 30 mins and transfer to low speed until fan stop working.

5. **TIMER**  : The fan is equipped with a timer that allows you to set its length of operation from 1 hour to 10 hours.(shown in FIGURE 4)

6. **OSCILLATION**  : Pressing the '  ' button will start and stop the oscillation function.

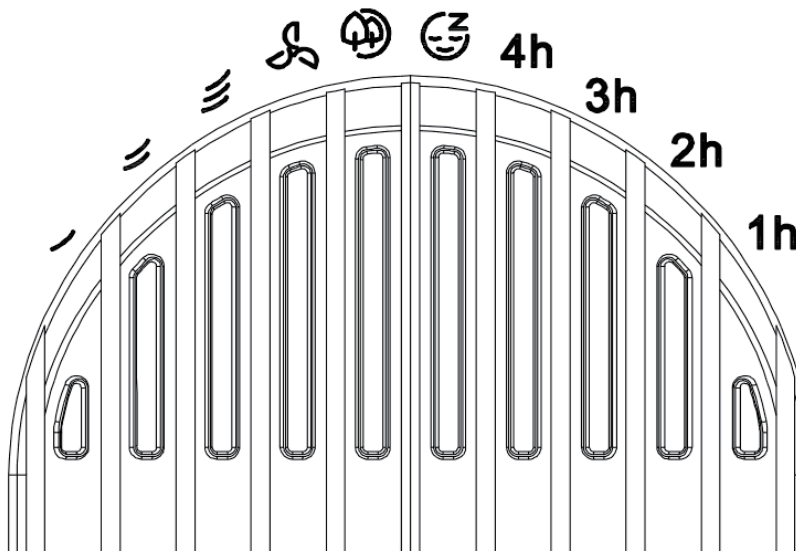
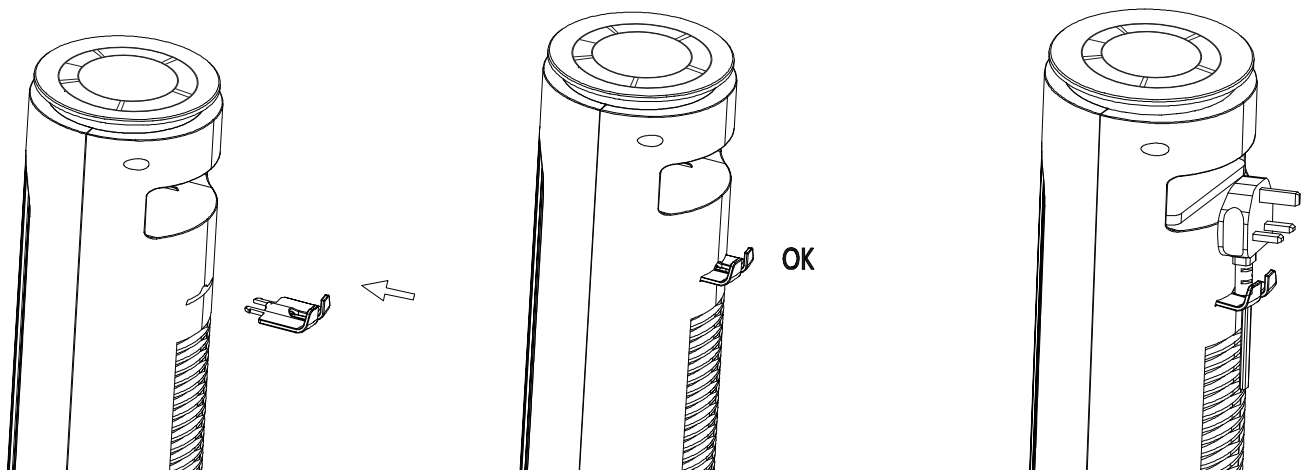

FIGURE 4

7. Cable Hook: The cable hook is packed with user manual, take it out and install at the back side of product. Hanging the power cord at cable hook when the fan is not be used.(FIGURE 5)



(FIGURE 5)

MAINTENANCE

1. This can only be done by an authorized service agent such as your local dealer or any agent qualified to undertake electrical repairs.
2. If the unit requires external cleaning make sure it is switched off and unplugged from the mains supply. Use a soft tissue or cloth for general cleaning. To remove more persistent dirt or grime wipe down with a cloth that has been dampened with warm soapy water. Do not use any solvents (such as thinners) as these may damage the plastic casing.

This appliance is not intended for use by persons (including children) with reduced physical, sensory or mental capabilities, or lack of experience and knowledge, unless they have been given supervision or instruction concerning use of the appliance by a person responsible for their safety.

Children should be supervised to ensure that they do not play with the appliance.

Correct Disposal of this product



This marking indicates that this product should not be disposed with other household wastes throughout the EU. To prevent possible harm to the environment or human health from uncontrolled waste disposal, recycle it responsibly to promote the sustainable reuse of material resources. To return your used device, please use the return and collection systems or contact the retailer where the product was purchased. They can take this product for environmental safe recycling.

