



INcjh010V01\_UK

**824-023V70**

## STAND FAN WITH REMOTE CONTROL



### Specifications

MODEL NO	RATED VOLTAGE	RATED POWER
<b>824-023V70</b>	220-240V~,50HZ	50W

READ AND SAVE THIS INSTRUCTION FOR FUTURE USE

# ASSEMBLY INSTRUCTION

# IMPORTANT SAFEGUARDS

When using an electrical appliance, basic safety precautions should always be observed, including the following:

## READ ALL INSTRUCTIONS BEFORE USING

**WARNING: To reduce the risk of fire, electrical shock, or injury to person:**

1. This fan is for household use only.
2. Before using for the first time, please check that your voltage is in accordance with the product nameplate requirements.
3. Please check the power cord and plug for any damage before use.
4. Always turn the fan OFF and unplug it from the electrical outlet when not in use.
5. Caution is necessary when the appliance is used near children.
6. Do not run the power cord under carpeting and do not cover the cord with throw rugs, runners or similar coverings. Do not route cord under furniture or appliances. Arrange cord away from traffic areas so that it will not be tripped over.
7. Do not operate any fan with a damaged cord or plug. Discard fan or return to an authorized service facility for examination and or repair.
8. If the fan's power supply cord is damaged, it must be replaced by the manufacturer or its service agent to avoid a safety hazard.
9. Use the fan in a well-ventilated area. When in use, place the fan at least 8 inches from any walls to ensure proper air flow. The fan must not be located immediately below or beside a curtain.
10. Do not obstruct the airflow with any objects or place anything inside the fan opening.
11. Do not use in areas where curtains could be sucked in.
12. Only place the fan on a hard, flat, dry floor.
13. Do not use in extreme temperatures, humidity, or dusty environments.
14. Do not place heavy objects on the fan.

15. Do not place the fan directly below a power outlet or you risk the cord being sucked in.
16. When the fan is oscillating do not manually turn the fan to avoid damage.
17. Always turn off the power supply before unplugging the power cord from the electrical outlet to prevent a short circuit, fire or electric shock.
18. Do not twist or pull the power cord.
19. Do not unplug the fan if your hands are wet, there is danger of electric shock.
20. Children under 8 should not operate the fan.
21. This appliance is not intended for use by persons (including children) with reduced physical, sensory or mental capabilities, or lack of experience and knowledge, unless they have been given supervision or instruction concerning use of the appliance by a person responsible for their safety.
22. Children should be supervised to ensure that they do not play with the appliance.
23. Ensure that the fan is switched off from the supply mains before removing the guard.
24. To reduce the risk of fire or electric shock, do not use this fan with any solid-state speed control device.
25. Please unplug or disconnect the appliance from the power supply before servicing.

## Structure and parts

1. Front grill
2. Blade fasten nut
3. Blade
4. Grill fasten nut
5. Back grill
6. Dam-board
7. Motor cover
8. Back control box
9. Control panel
10. Bolt
11. Power cable
12. Adjustable tube
13. Fixing tube clamp
14. Tube
15. Base
16. Gasket
17. L shape screw

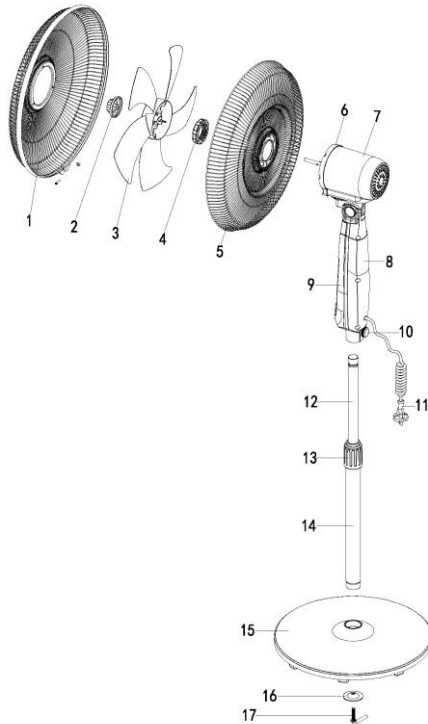

## Assembly Instructions

The fan is packaged with its grills un-attached. You must attach the grills before operating the fan.

**WARNING: Never operate the fan without its foundation and other parts. The fan must only operate in the up-right position, and any other position will be hazardous.**

Do operate the fan only in upright position; any other position could create a hazardous situation.

Assemble the foundation and other parts of the appliance in the following sequence:

- a). Unpack the fan and remove all parts from the package
- b). Use the grill fasten nut(4) for the back grill(5) to attach the back grill(5) to the fan head, and then use the blade fasten nut(2) for the fan leaf to hold the fan leaf in place.
- c). To attach the front grill(1) to the back grill(5), you must use the grill ring carefully to hold them together, and fasten the grill ring with the screw provided.
- d).insert the tube(14) into the base's hole(15), place the gasket(16) under the base(15) and tighten L shape screw(17).
- e). Loosen fixing tube clamp(3), then pull up adjustable tube(12), and tighten fixing tube clamp(13), then put the adjustable tube(12) into control panel(9), and tighten bolt(10).

## **Operating Instructions**



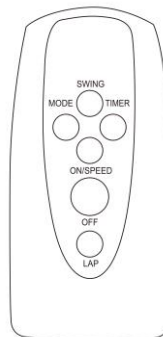

Control Panel





Remote control

1. Before using the fan, make sure that it is on a flat and stable surface. Damage may occur if the fan is placed on an incline or decline.

2. Set all the switches to the “OFF” position, and then insert the plug directly into a standard AC socket-outlet. Be sure that the plug fits tightly into the socket-outlet.

3. Press “ON/SPEED” on the remote or on control panel to start the fan. Press “ON/SPEED” button again to select the fan speed level. The fan have three speed level.  means low speed level,  means middle speed level,  means high speed level.

Press “MODE” button to select the fan mode, the fan have three mode.  means “NORMAL” wind.  means “NATURAL” wind.  means “SLEEP” wind.

Press “TIMER” button to set timer from 0.5hour to 7.5 hour. Every time press this button will add 0.5H timer. To cancel the set timer, press the “TIMER” button again until all the timer indicate turn off.

To stop the fan, just press the button “OFF” on remote or “” on control panel.

4. If you want to increase the blast area in your room, press “SWING” button on remote or press “OSC” on control panel, the LED screen will indicate  , and the fan will oscillate and blast your room in large scope. To stop oscillating, just press it again. Moving the fan head either up or down will change the direction of the wind.

5. Press “LAP” button on the remote control, the indicate will goes off, press “LAP” button again, the indicate will light up.

6. Remove the plug from the socket-outlet to completely shut the fan off.

### **Cleaning / Maintenance Instructions**

To safely take care of your fan, please remember to follow these instructions below:

1. Always remove the plug from the socket-outlet, and allow the fan to stop completely before cleaning the fan.
2. Do not allow water to drip on, or enter into the fan housing.
3. Always use a soft cloth, moistened with a mild soap solution.
4. Do not use any of the following agents as a cleaner: Gasoline, Thinners, or Benzene.
5. In case of malfunction or doubt, do not try to repair the fan yourself, it may result in a fire hazard or electric shock.

### **FAN Cleaning**

Clean the fan grill, housing and base with a soft damp cloth. Do not attempt to remove the fan blades. Please use caution around the motor housing area. Do not allow the motor, or other electrical components to be exposed to water.

## **FAN Storage**

When storing your fan in the off-season, it is important to keep it in a safe dry location. It is important to protect the fan head from any dust. We strongly recommend using the original box, when storing the fan away.

## **Waste disposal**



The symbol  indicates that this product is not to be disposed of together with household waste. This product must be delivered to a recycling service or container for electrical appliances and electronic equipment. This is done to avoid health risks and prevent harm to the environment. Local businesses (or the environmental station in your neighborhood) are required by law to accept and recycle such products, as a means of environmentally sound disposal.