

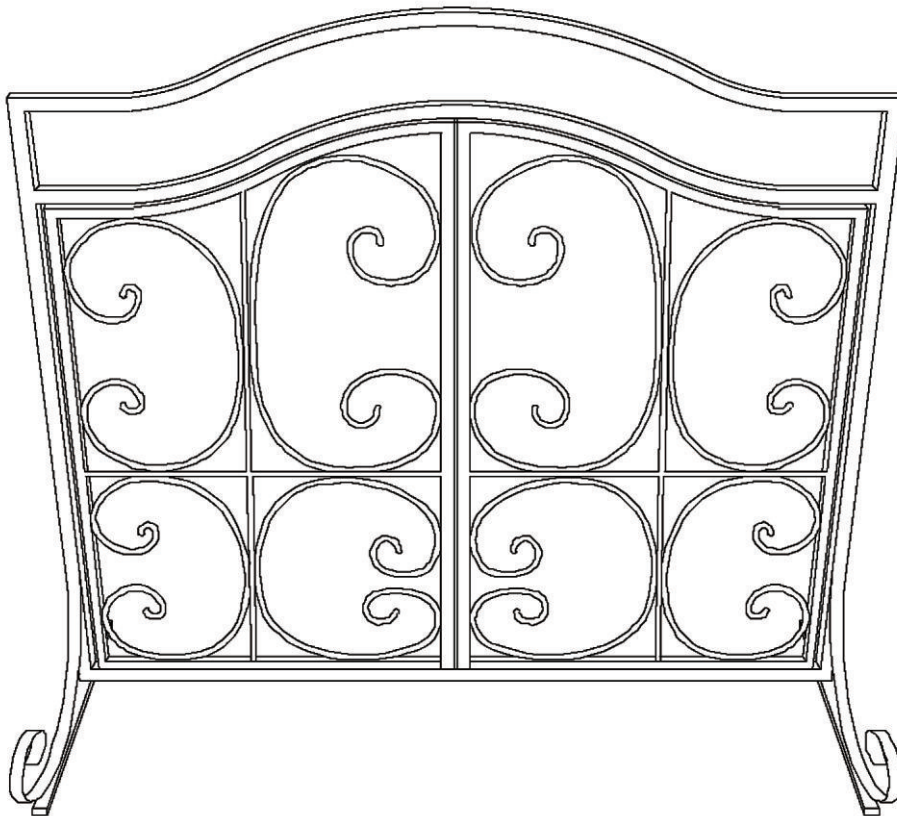

INcji003_GL_

820-239



IMPORTANT, RETAIN FOR FUTURE REFERENCE: READ CAREFULLY

ASSEMBLY & INSTRUCTION MANUAL

PARTS

A x01



B x02



HARDWARE

C x04

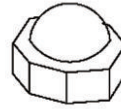

D x01



01

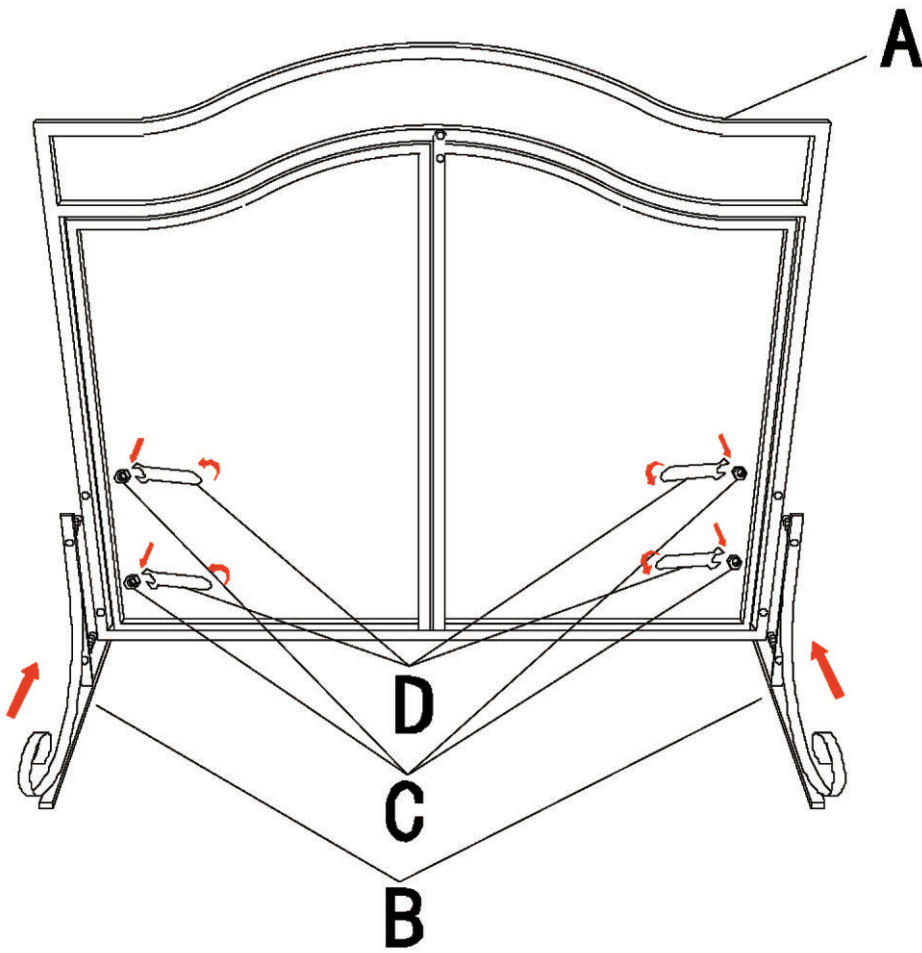

02

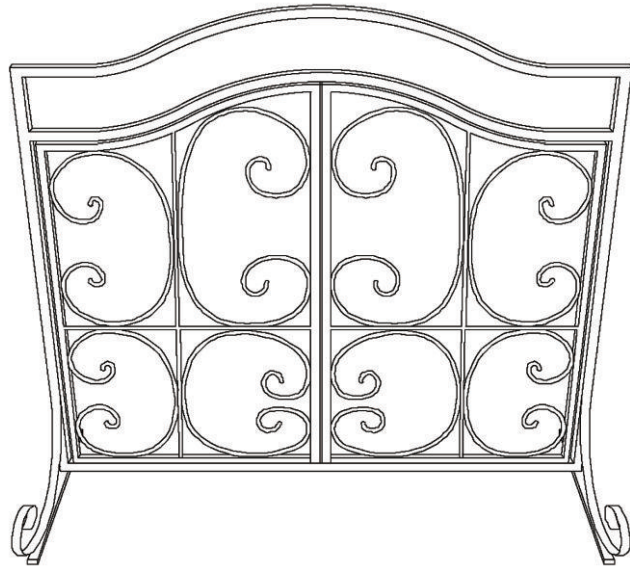

Done