

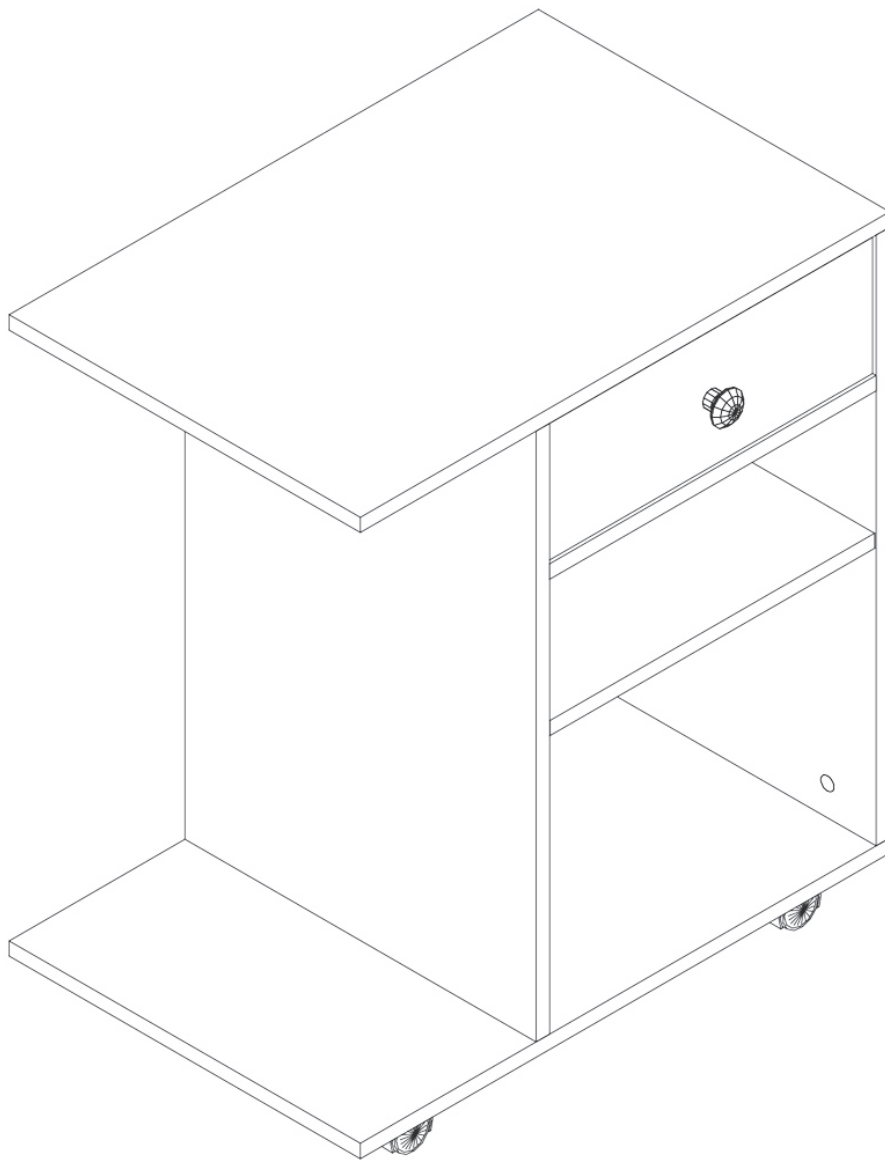

INcka030V01\_US\_CA\_UK\_ES\_DE\_IT

**920-069**



IMPORTANT, RETAIN FOR FUTURE REFERENCE: READ CAREFULLY

**ASSEMBLY INSTRUCTION**

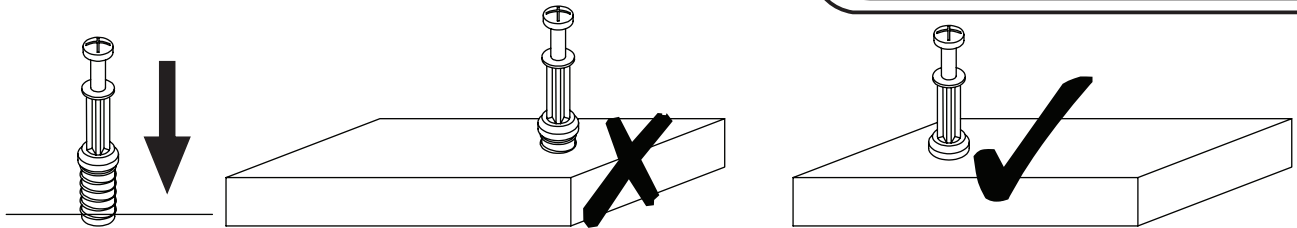

**EN\_QUICKFIT:** Tighten quickfit until shoulder is flush with panel. Do not overtighten or undertighten.

**FR\_RACCORD RAPIDE:** Faites serrer le raccord rapide jusqu'à ce que l'épaulement soit parfaitement encastré dans le panneau. Il ne faut ni trop serrer ni insuffisamment serrer.

**ES\_QUICKFIT:** Apriete quickfit hasta que el hombro se descargue con el panel. NO lo sobreapriete ni lo apriete poco.

**DE\_QUICKFIT:** Ziehen Sie den Quickfit fest, bis die Schulter mit der Platte bündig ist. Bitte nicht zu fest oder zu schwach anziehen.

**IT\_MONTAGGIO RAPIDO:** Stringere il montaggio rapido fino a quando la spalla è a filo con il pannello, non stringere troppo o troppo poco.

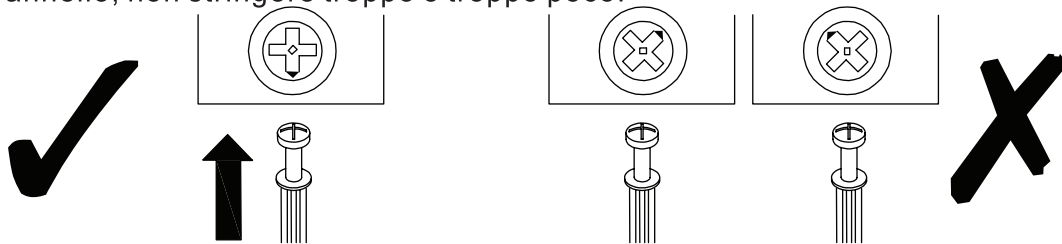

**EN\_CAM LOCK:** When fitting cam lock, ensure starting position is correct before you insert connecting quickfit.

**FR\_SERRURE BATTEUSE:** Avant d'insérer la serrure batteuse, veillez à la bonne orientation avant d'insérer le raccord rapide.

**ES\_CIERRE DE LA CÁMARA:** Cuando instale el cierre de la cámara, asegúrese de que la posición de inicio es correcta antes de que inserte el quickfit conector.

**DE\_CAM-LOCK:** Achten Sie bei der Montage des Cam-Locks auf die richtige Ausgangsposition, bevor Sie den Quickfit einsetzen.

**IT\_BLOCCAGGIO A CAMMA:** Quando si monta il bloccaggio a camma, assicurarsi che la posizione iniziale sia corretta prima di inserire il montaggio rapido di collegamento.

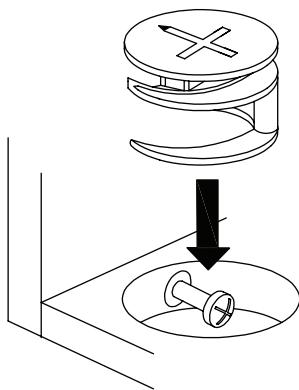

**EN\_Quickfit head** should be in the centre of the cam lock when the two panels are joined.

Cam lock should be inserted before quickfit.

**FR\_**Lorsque les deux panneaux sont assemblés, la tête du raccord rapide doit reposer au centre de la serrure batteuse. Il faut insérer la serrure batteuse avant le raccord rapide.

**ES\_**El cabezal del quickfit debe estar en el centro del cierre de la cámara cuando se unan los dos paneles.

Se debe insertar el cierre de la cámara antes que el quickfit.

**DE\_**Der Quickfit-Kopf sollte sich in der Mitte des Cam-Locks befinden, wenn die beiden Platten zusammengefügt sind.

Der Cam-Lock sollte vor dem Quickfit eingesetzt werden.

**IT\_**La testa del montaggio rapido deve trovarsi al centro del bloccaggio a camma quando i due pannelli sono uniti.

Il Bloccaggio a Camma deve essere inserito prima del montaggio rapido.

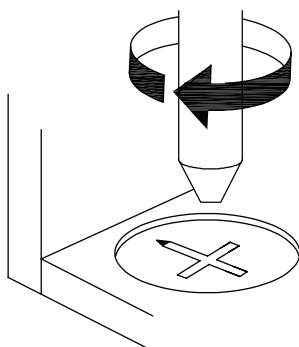

**EN\_**Turn cam lock clockwise to tighten.

**FR\_**Faites tourner la serrure batteuse dans le sens des aiguilles d'une montre pour la resserrer.

**ES\_**Gire el cierre de la cámara en sentido horario para apretarlo.







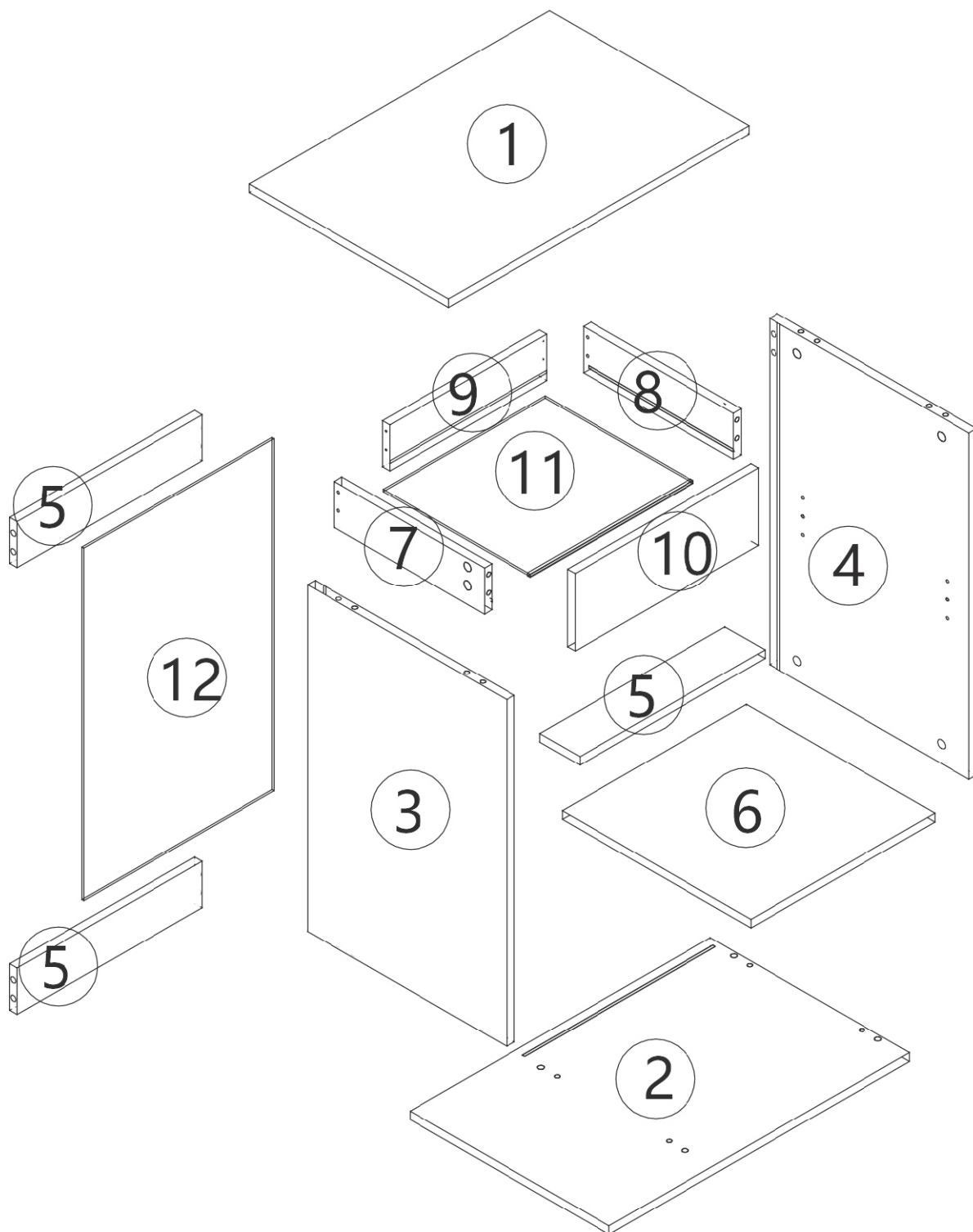



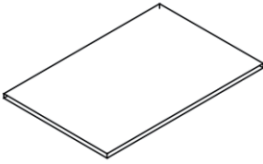

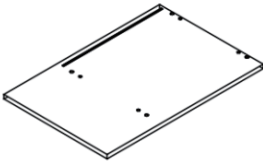

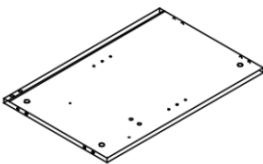
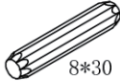
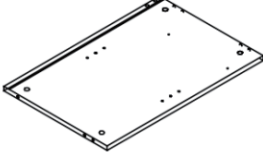



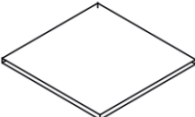

**DE\_**Drehen Sie den Cam-Lock im Uhrzeigersinn, um ihn festzuziehen.

**IT\_**Ruotare il bloccaggio a camma in senso orario per stringere.

# Assembly Instructions

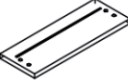

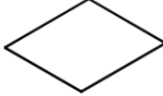
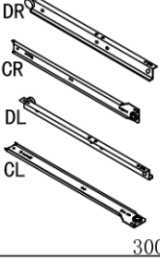
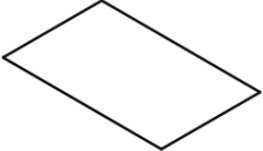
# PACKING DEAILS:TOTAL 1 BOXES





PARTNO.	PARTS	QTY		PARTNO.	PARTS	QTY
1		X1		A		X24
2		X1		B		X24
3		X1		C	 8*30	X8
4		X1		D		X4
5		X3		E	 3.5*35	X4
6		X1		F	 3.5*14	X24
7		X1		G		X1
8		X1		H		X1
9		X1		I		X2
10		X1		J		X2
11		X1		K	 DR CR DL CL 300	X1
12		X1		L		X20

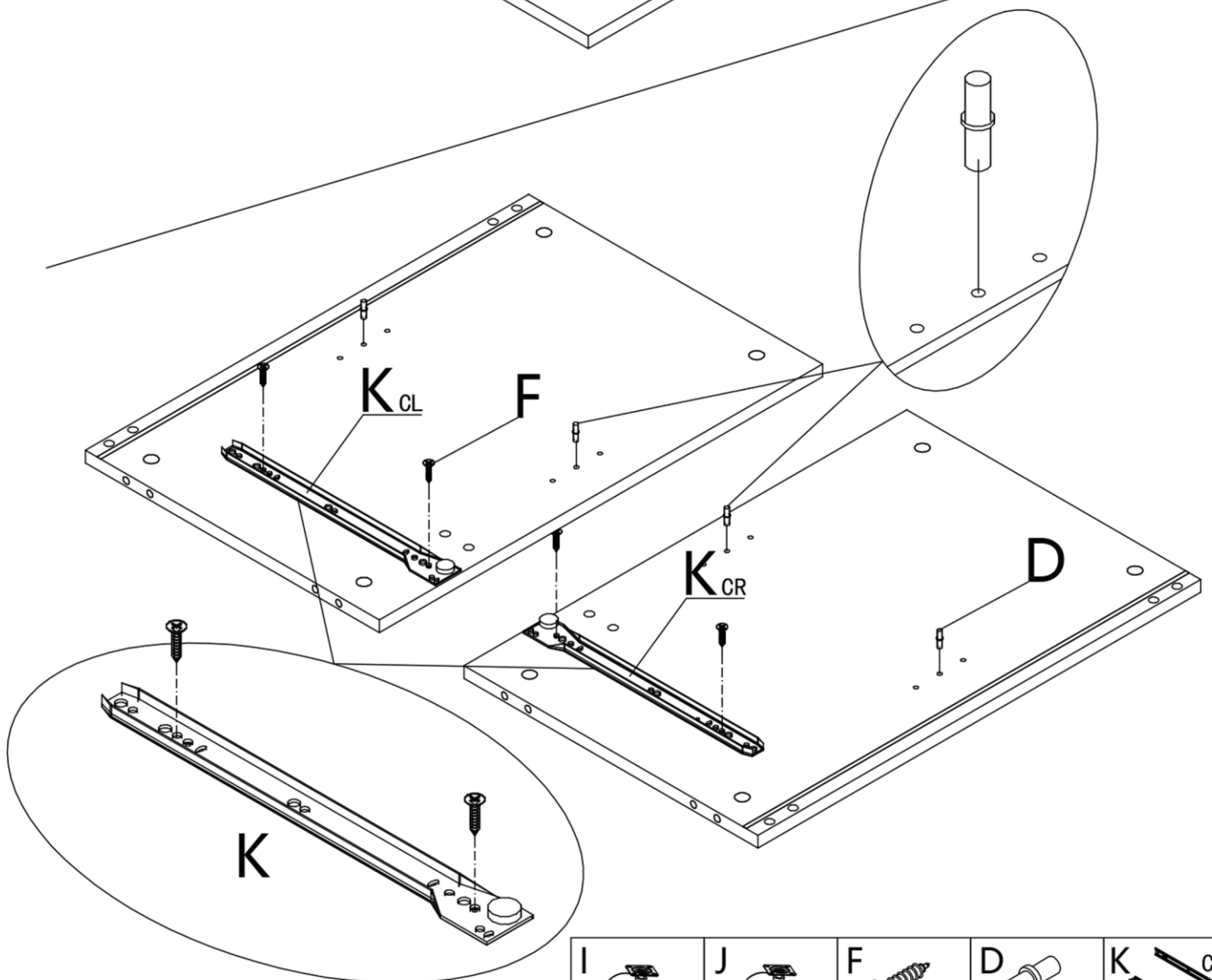
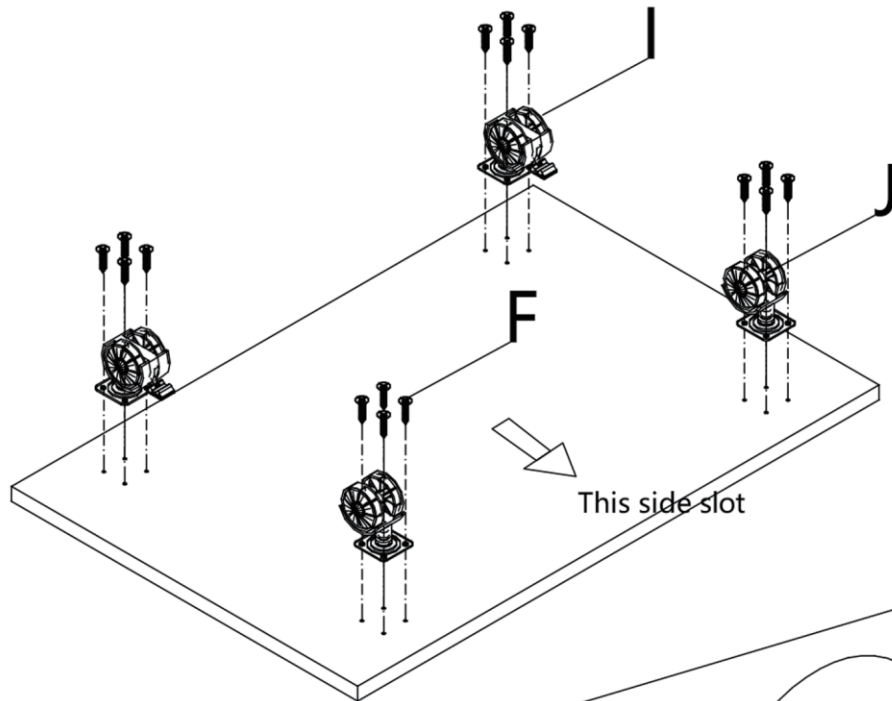

# Assembly Instructions

1

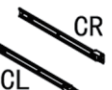

 I 2pc	 J 2pc	 F 20pc	 D 4pc	 K CL 1pc CR
---	--	--	---	--

# Assembly Instructions

2

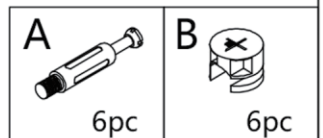
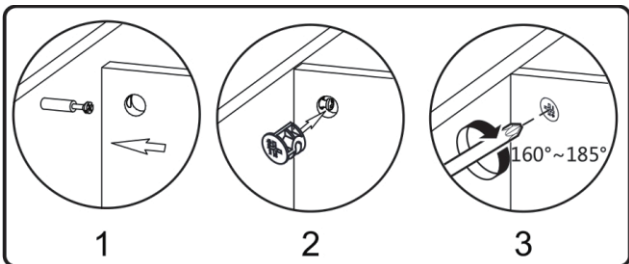
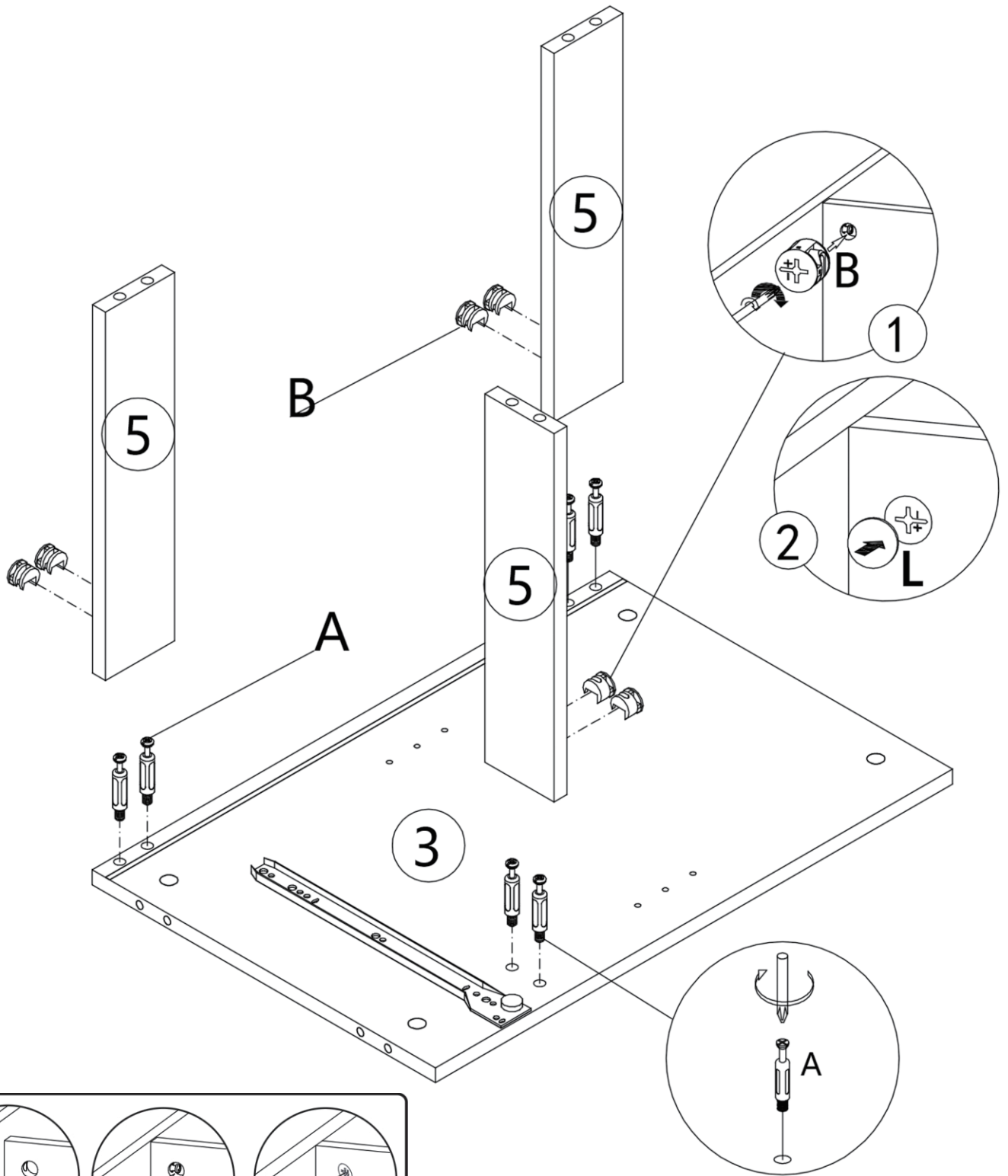

# Assembly Instructions

3

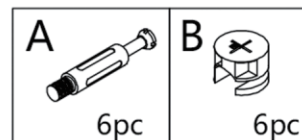
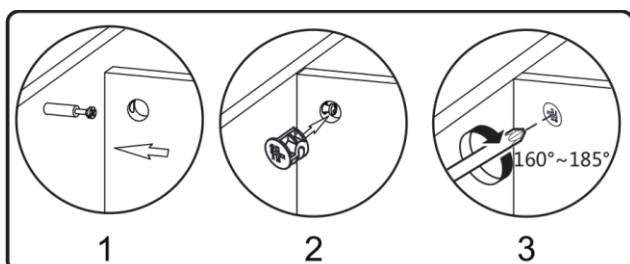
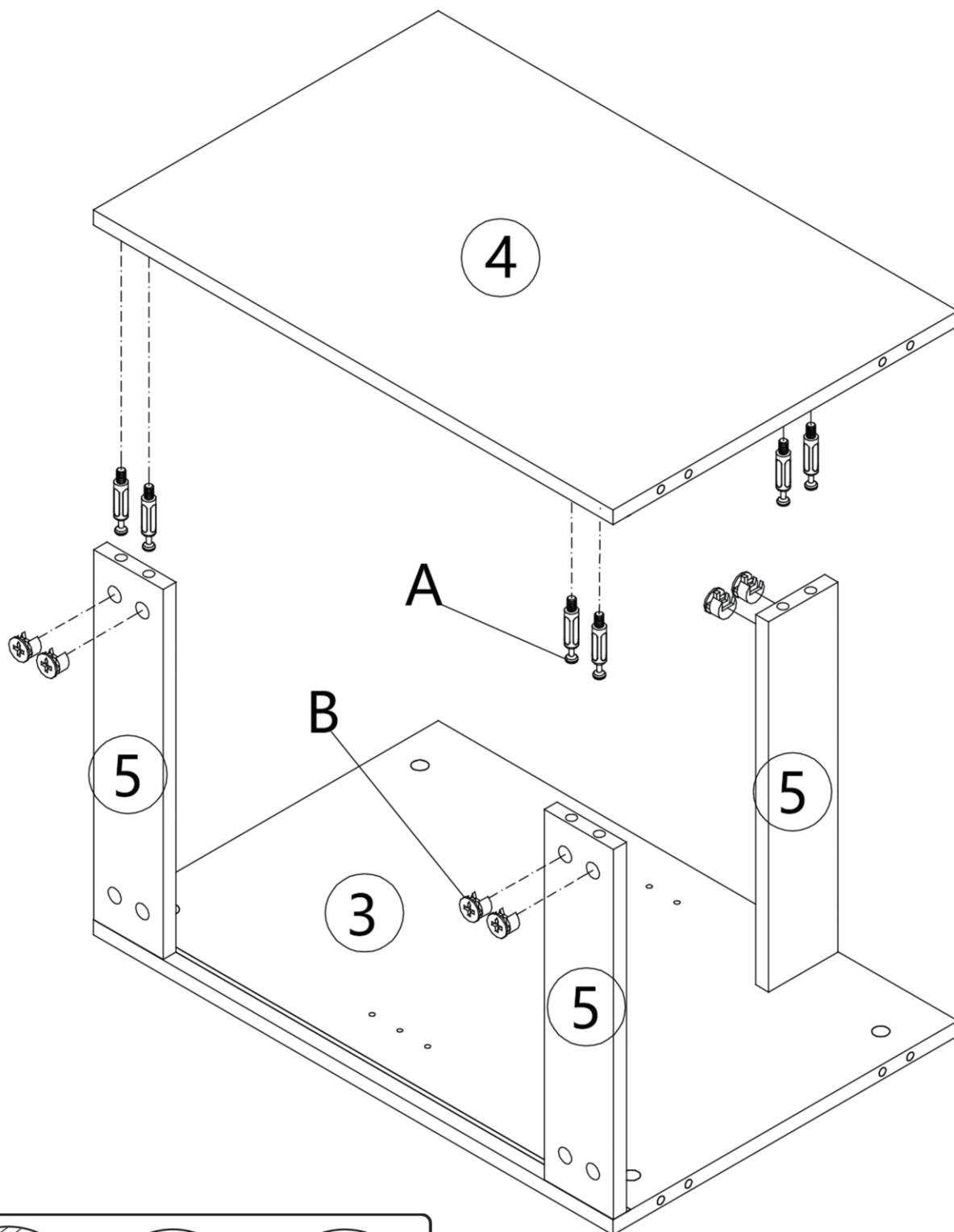

# Assembly Instructions

4

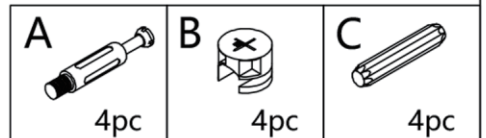
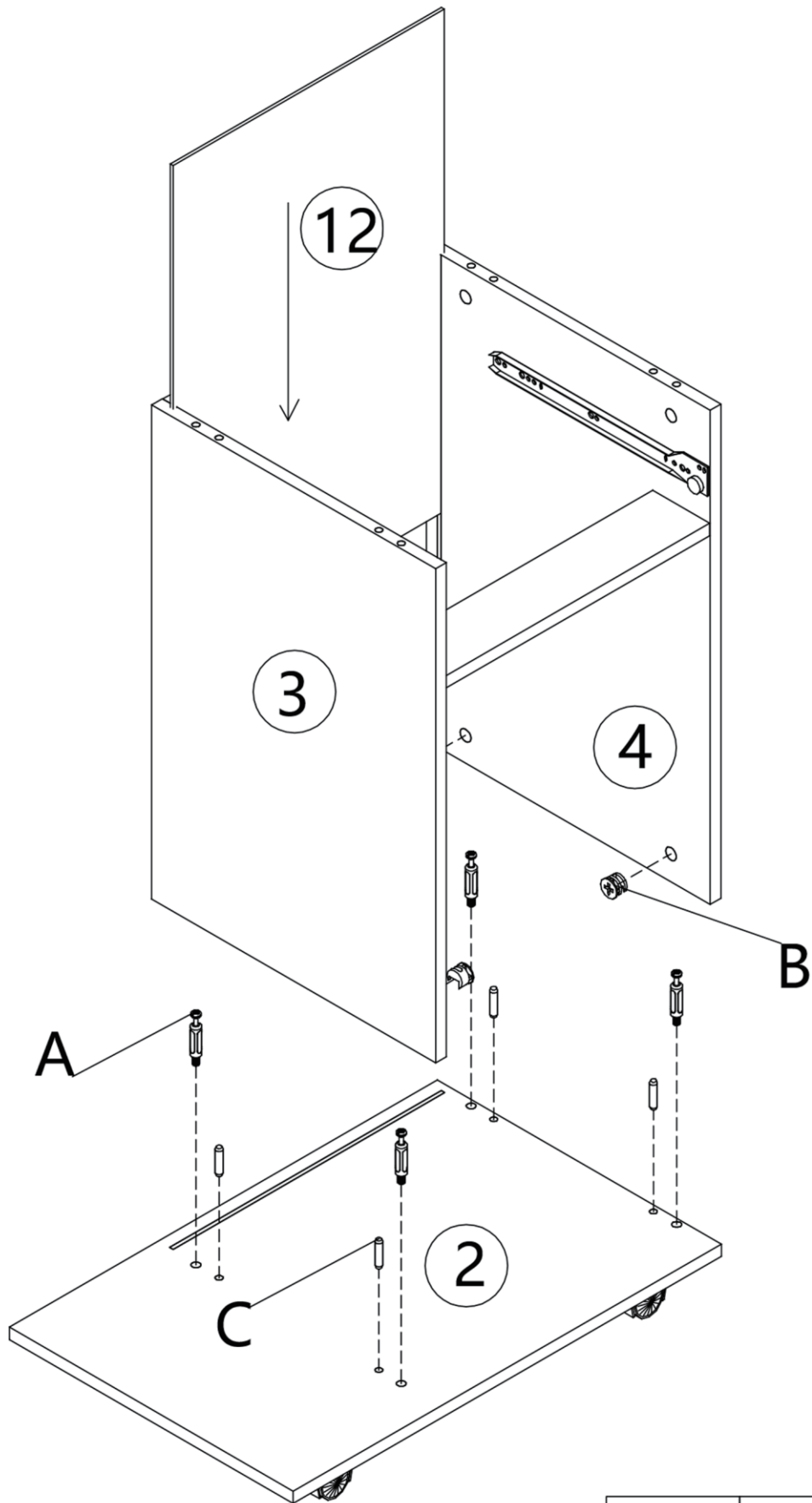

# Assembly Instructions



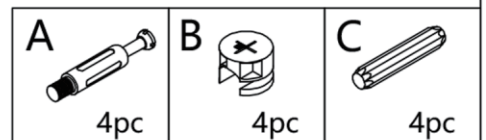
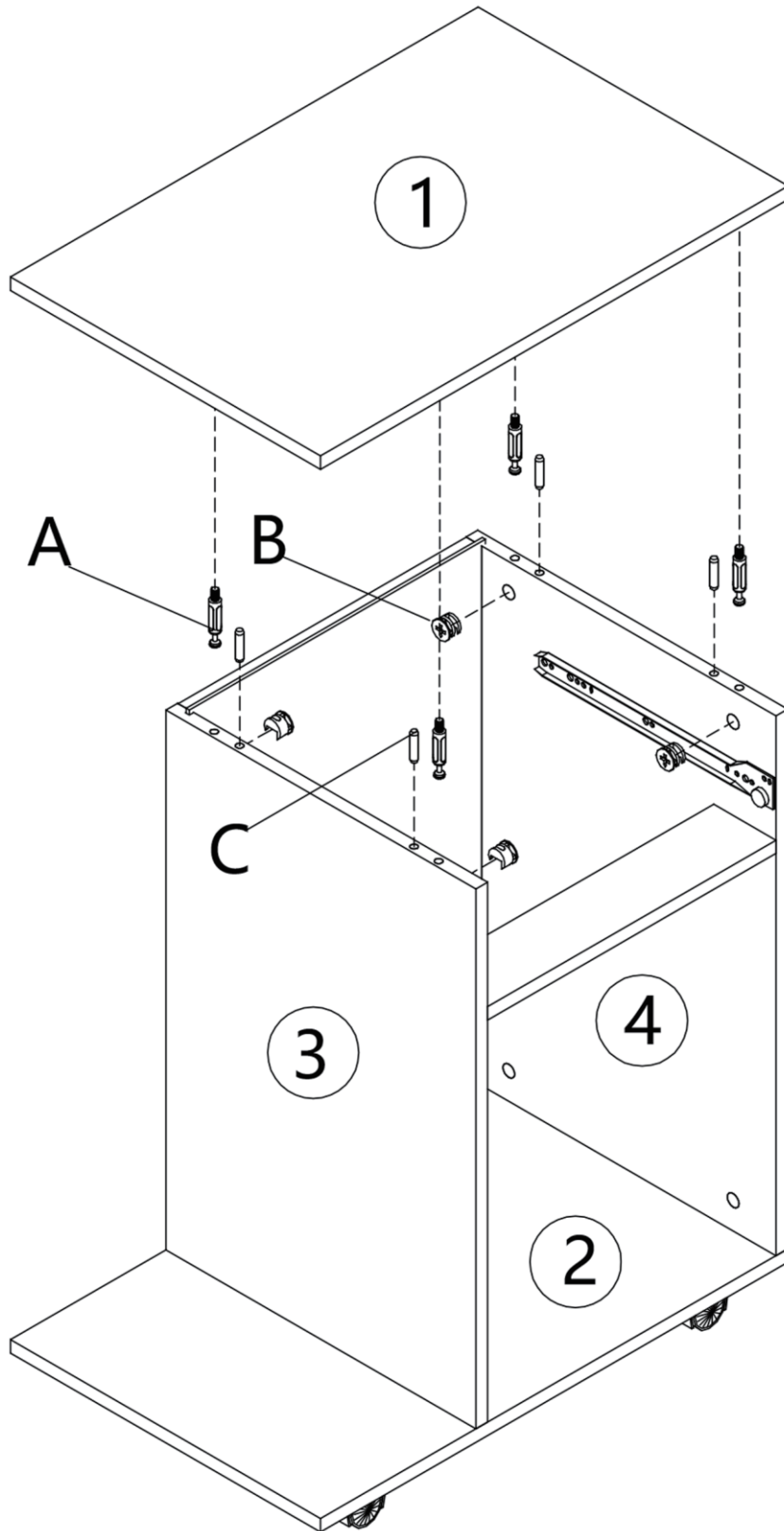



5

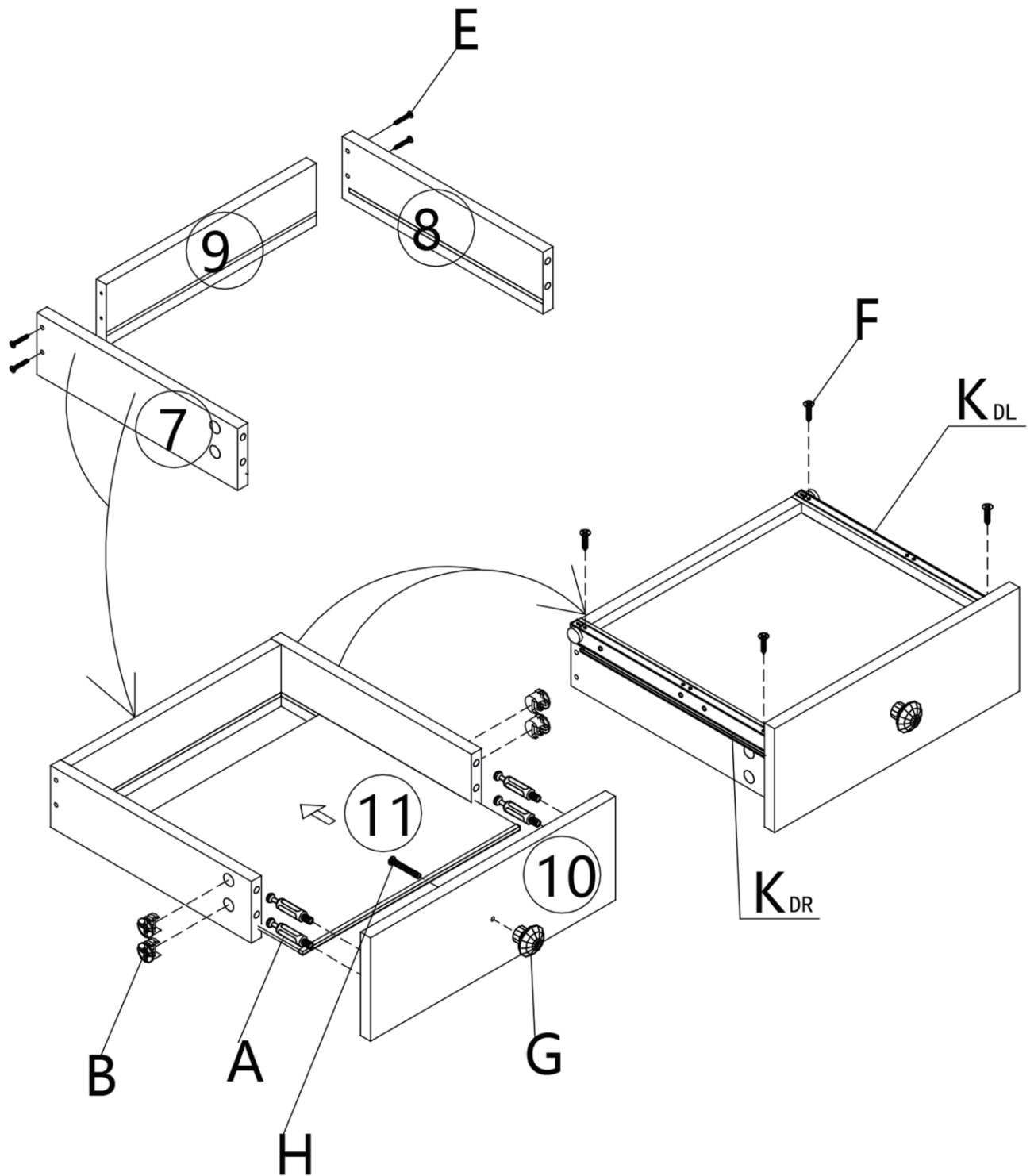

# Assembly Instructions

6

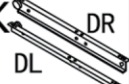

<b>A</b>  4pc	<b>B</b>  4pc	<b>E</b>  4pc	<b>F</b>  4pc	<b>G</b>  1pc	<b>H</b>  1pc	<b>K</b>  DL DR 1pc
--	--	--	---	--	--	---

# Assembly Instructions

7

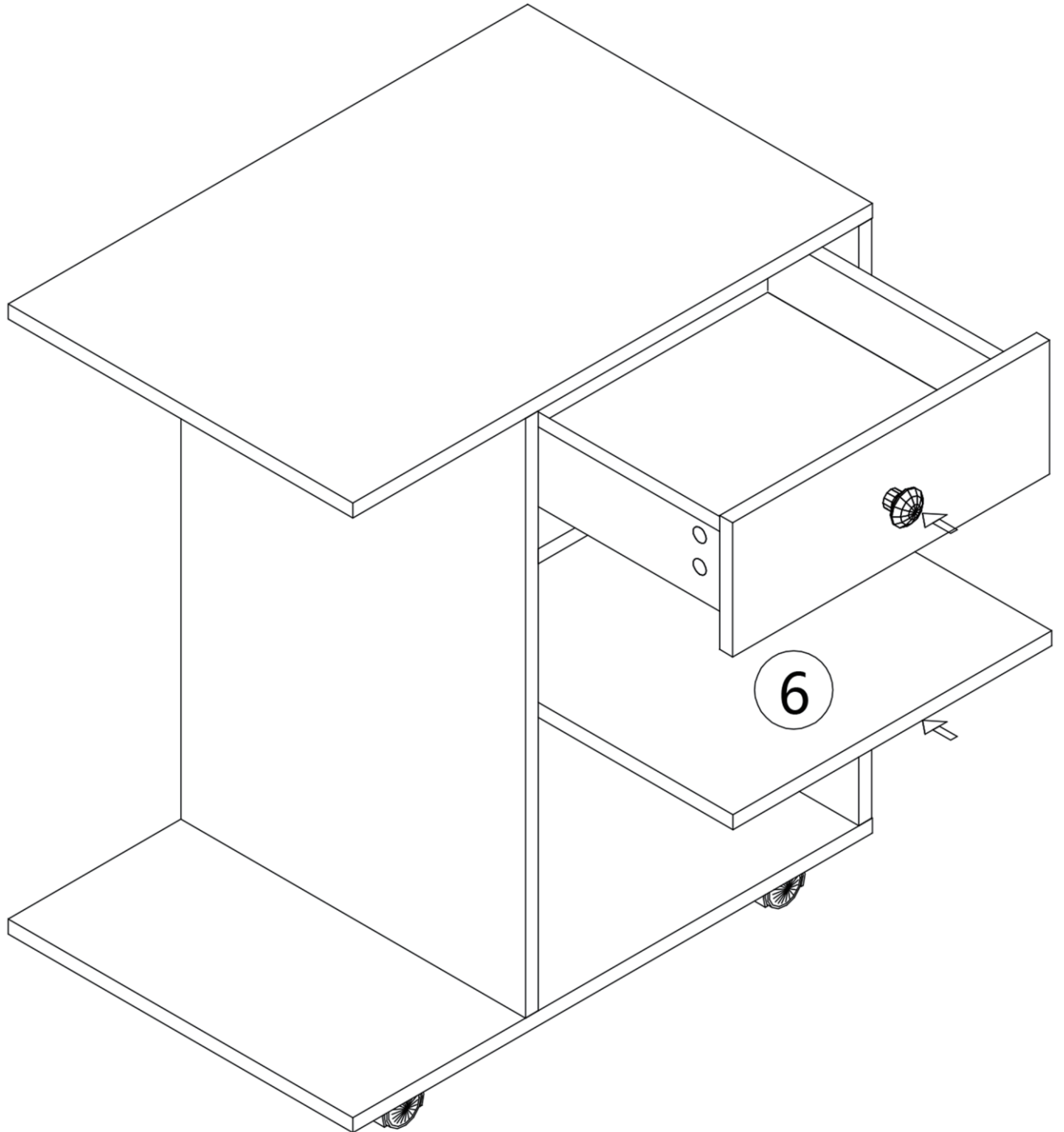

# Assembly Instructions

8

