

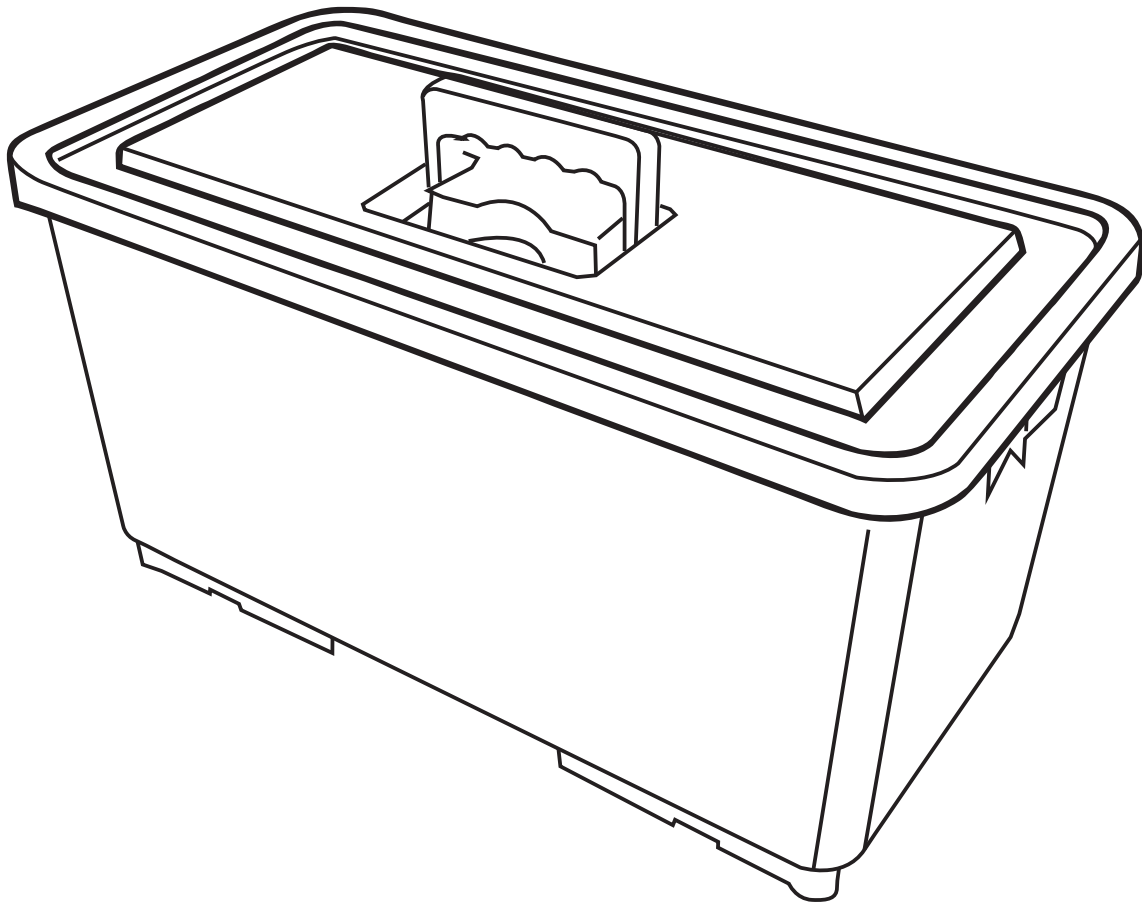

INcmc038\_GL

**720-023**



IMPORTANT, RETAIN FOR FUTURE REFERENCE: READ CAREFULLY

# ASSEMBLY & INSTRUCTION MANUAL

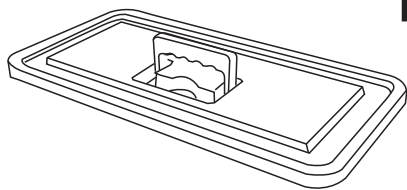

**A** x 1

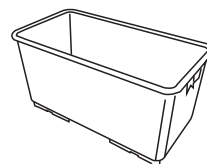

**B** x 1

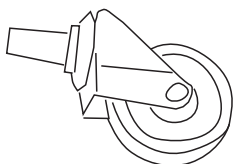

**C** x 4

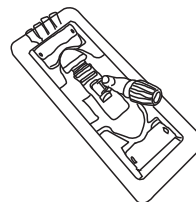

**D** x 1

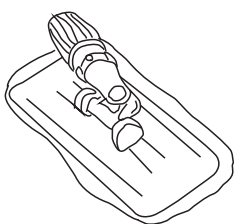

**E** x 1

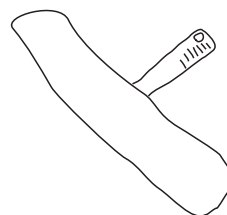

**F** x 1

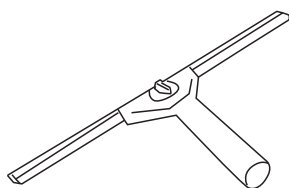

**G** x 1

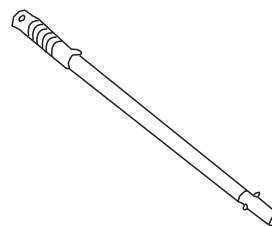

**H** x 1

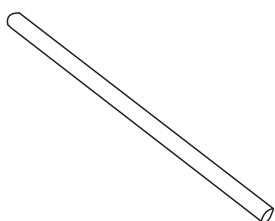

**I** x 1

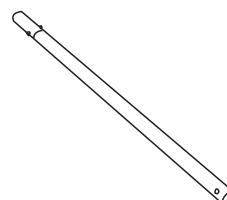

**J** x 1

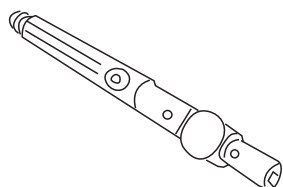

**K** x 1

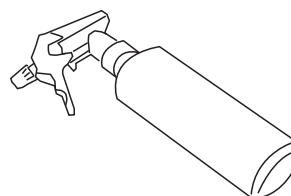

**L** x 1

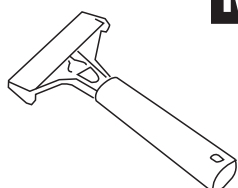

**M** x 1

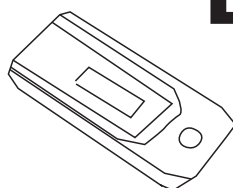

**N** x 1

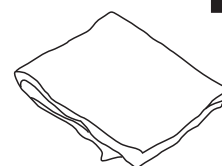

**O** x 2

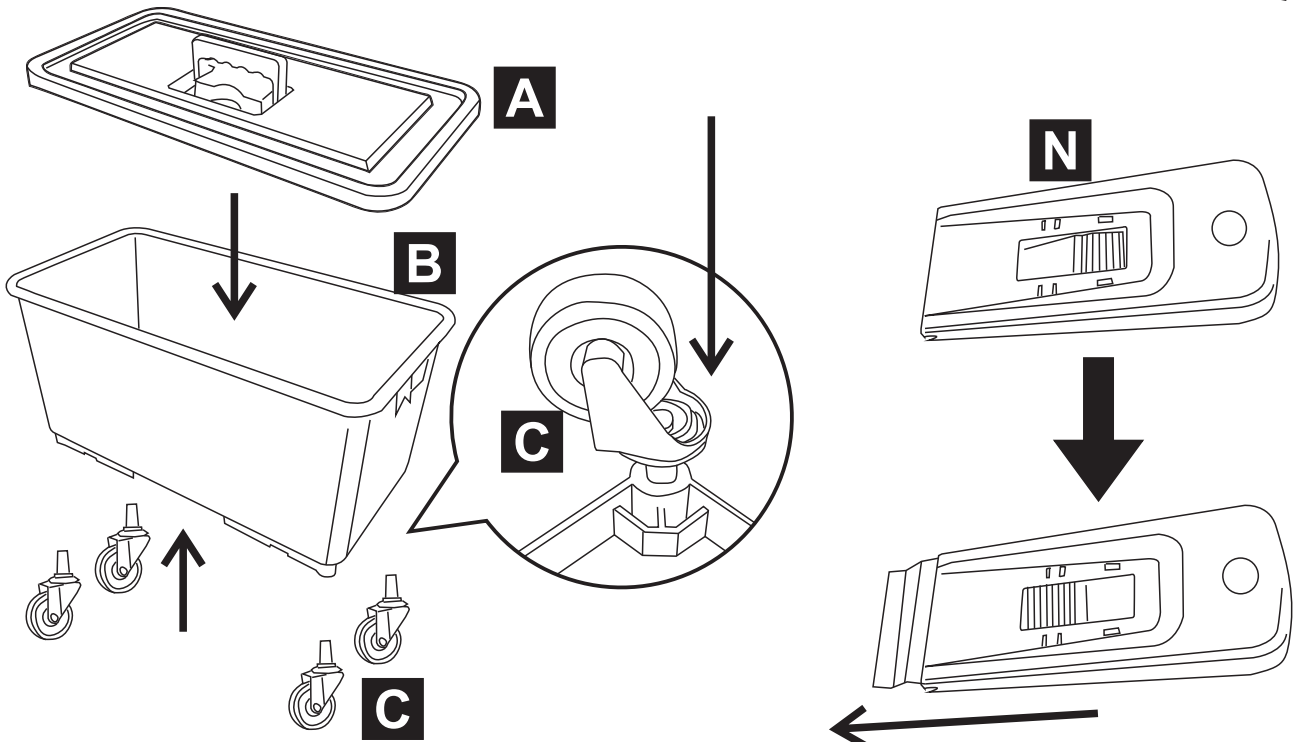
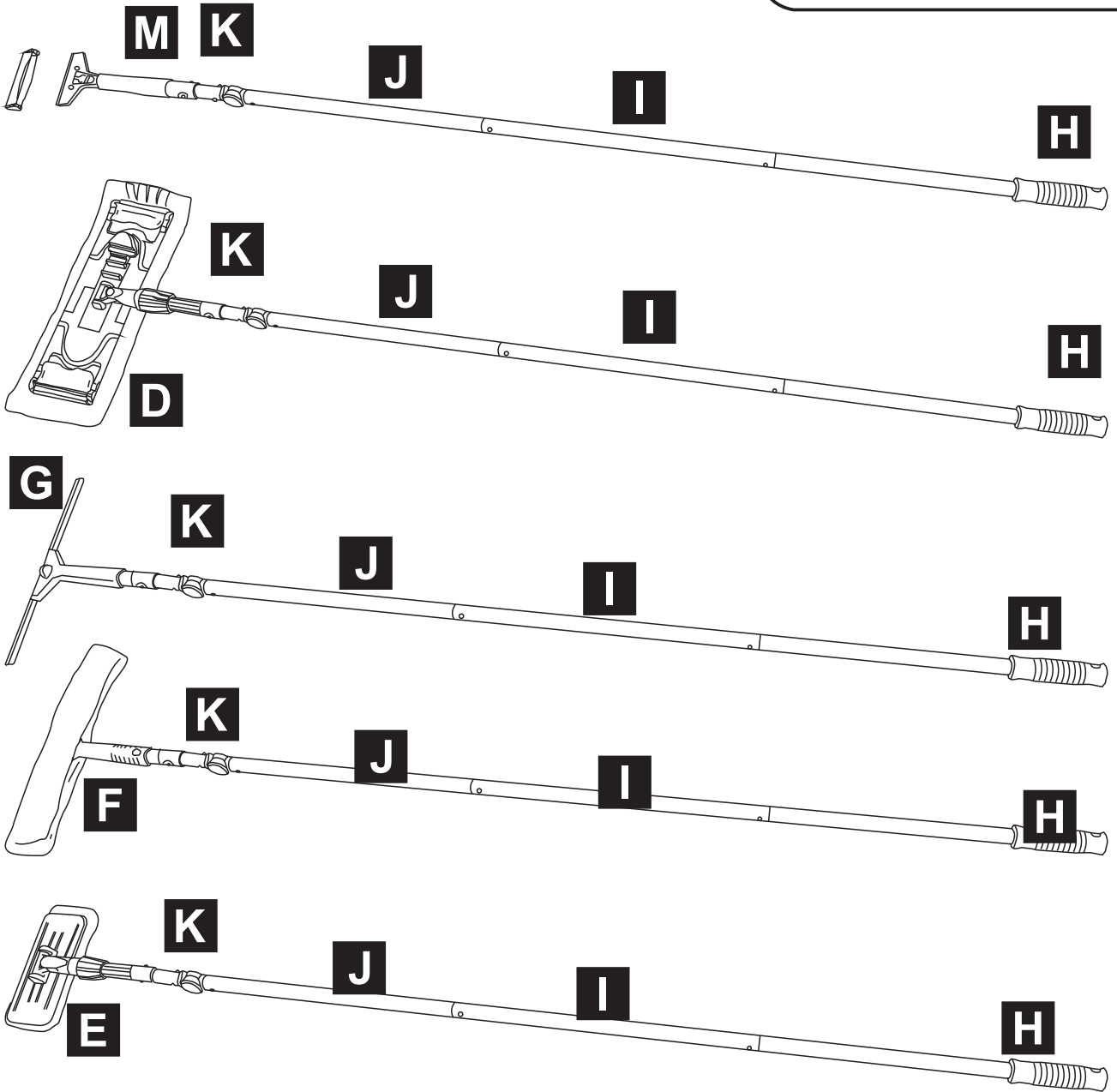

US



001-877-644-9366  
customerservice@aosom.com

CA



001-855-537-6088  
customerservice@aosom.ca

UK



0044-800-240-4004  
enquiries@mhstar.co.uk

DE



0049-(0)40-88307530  
service@aosom.de

FR



0033-1-84166106  
contact@aosom.fr

ES



0034-931294512  
atencioncliente@aosom.es

IT



0039-0249471447  
clienti@aosom.it