

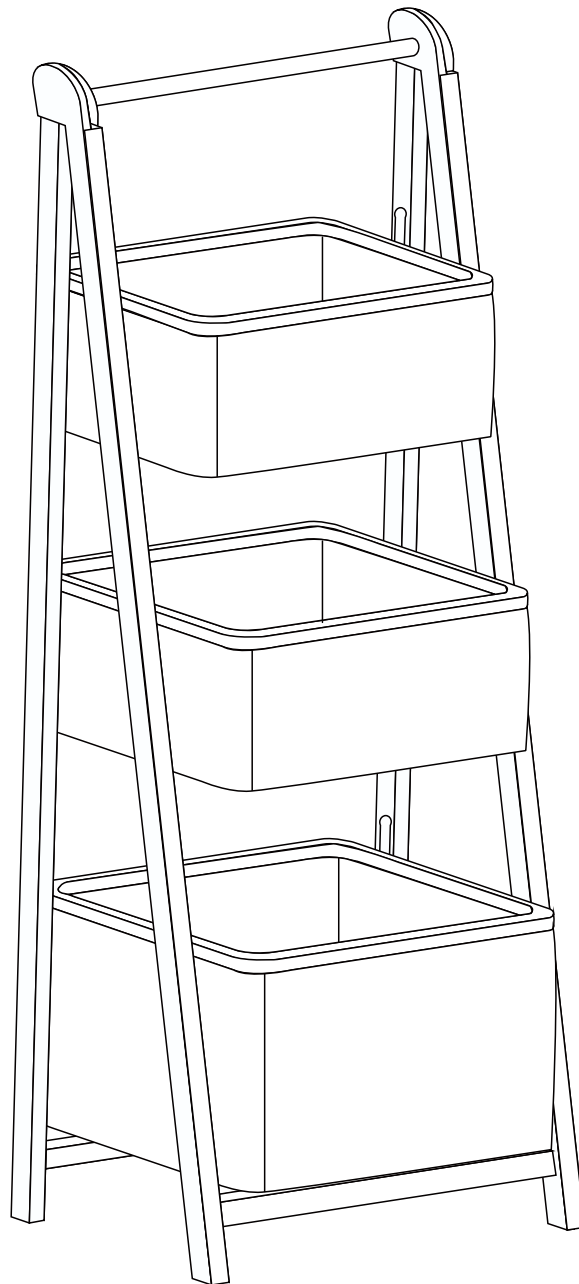

INcmc055_GL

850-153



IMPORTANT, RETAIN FOR FUTURE REFERENCE: READ CAREFULLY

ASSEMBLY & INSTRUCTION MANUAL

PARTS

A x01

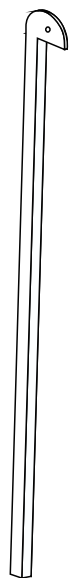

B x01

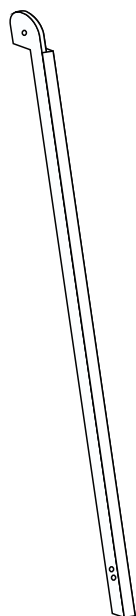

C x01

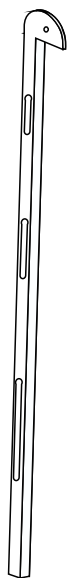

D x01

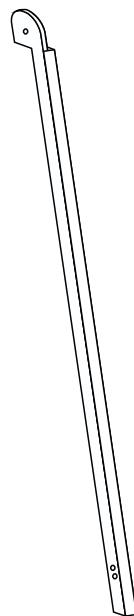

E x01



F x01

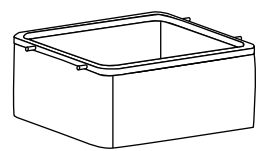

H x02



G x01

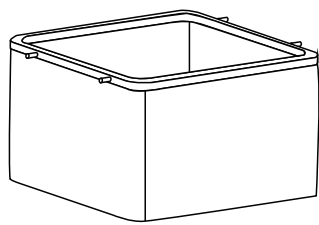

I x01

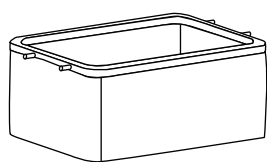

HARDWARE

a x10
+1(spare)

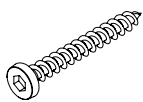

b x01

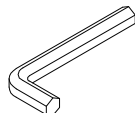

A x01



B x01

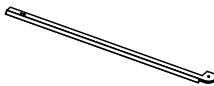

E x01



H x02



a x05

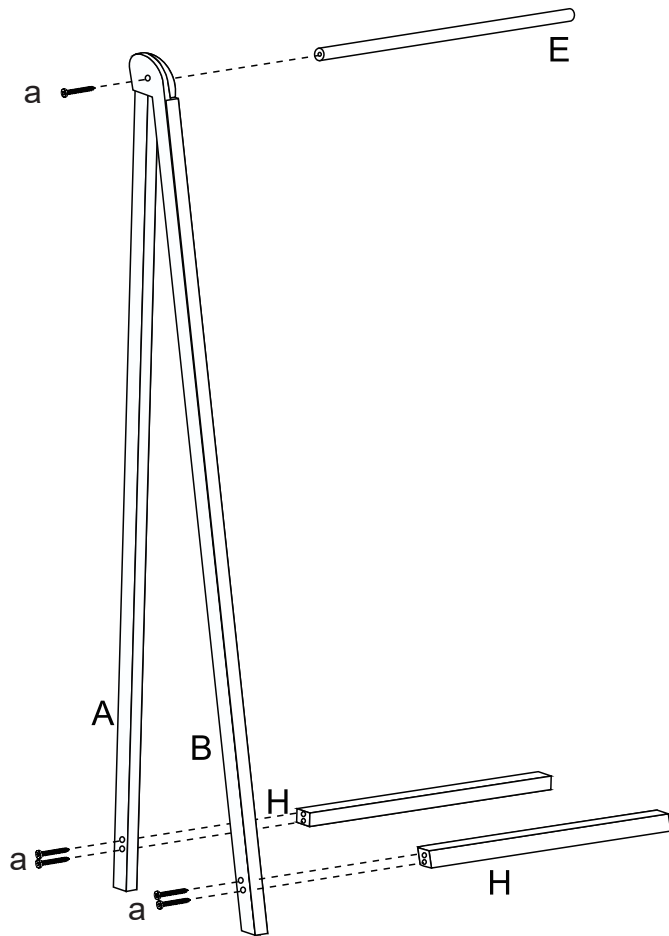

C x01



D x01



F x01

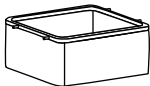

G x01

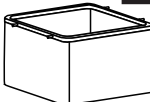

I x01



a x05

