

IMPORTANT, RETAIN FOR FUTURE REFERENCE: READ CAREFULLY

ASSEMBLY & INSTRUCTION MANUAL

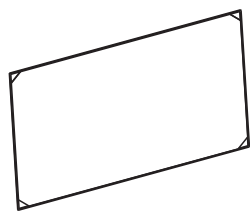

A x22
35*45

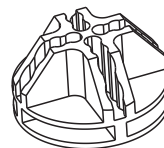

B x30
+1(spare)

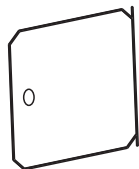

C x 8
35*35

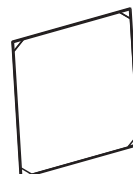

D x 8
35*35

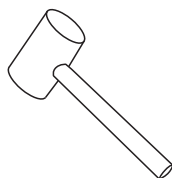

E x 1

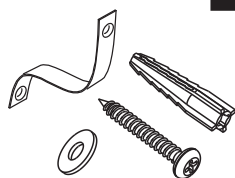

F x 2

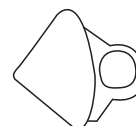

G x12

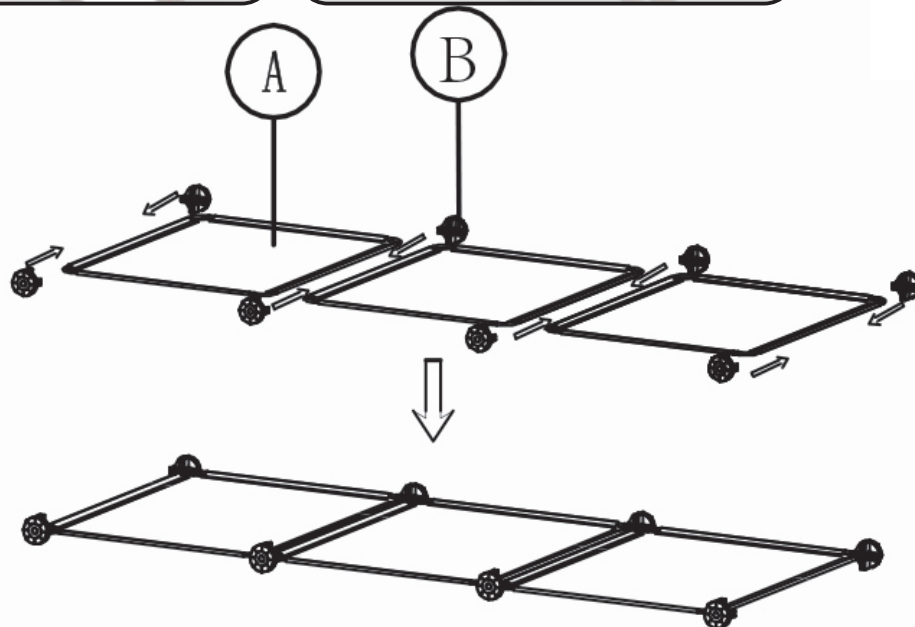
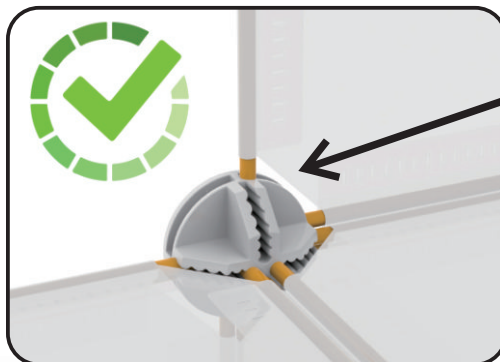
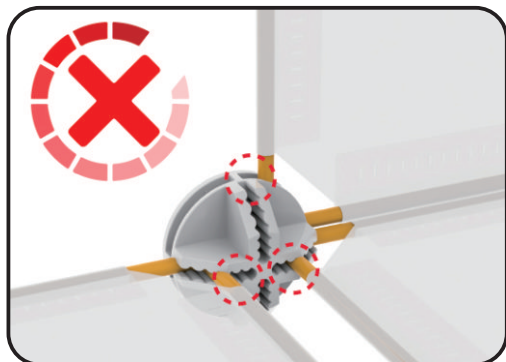

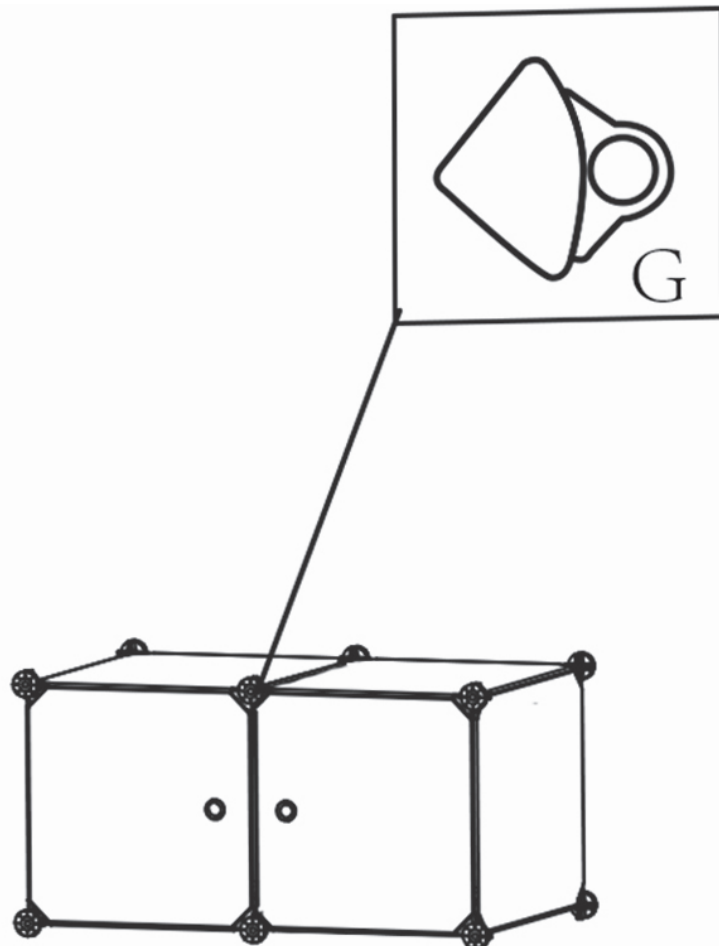
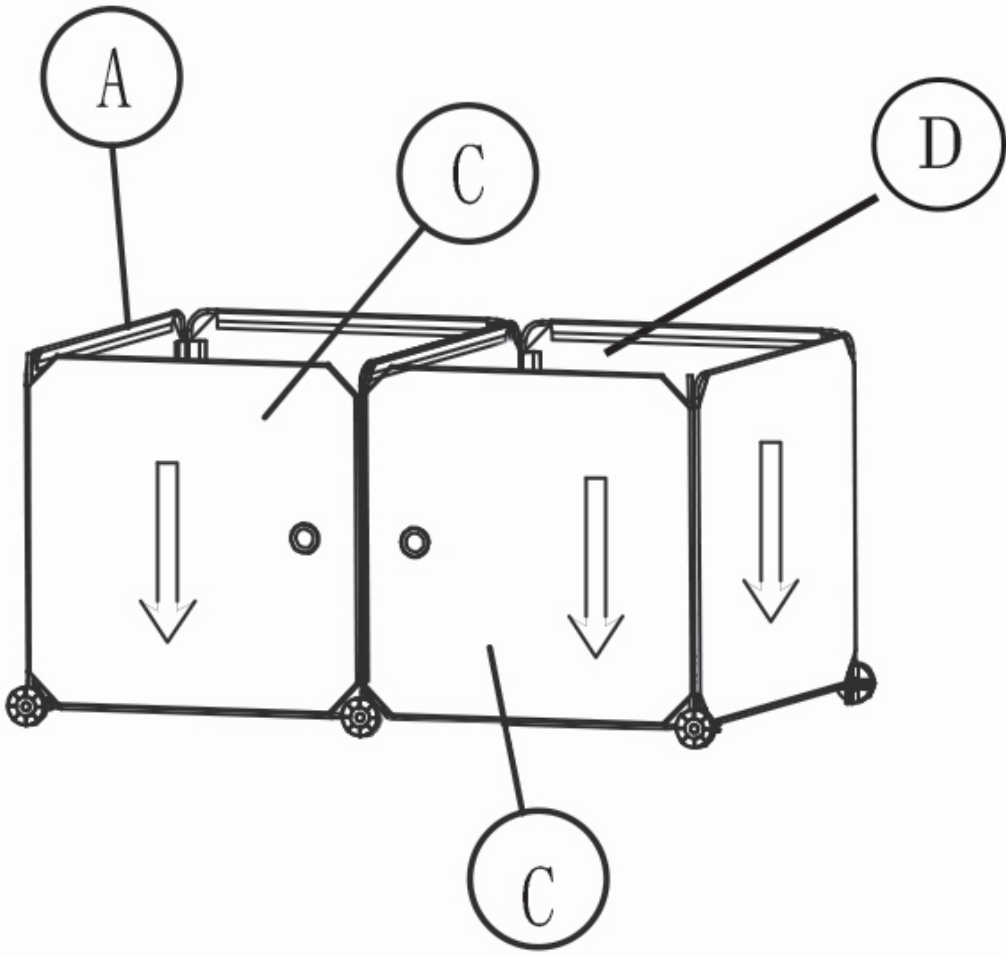

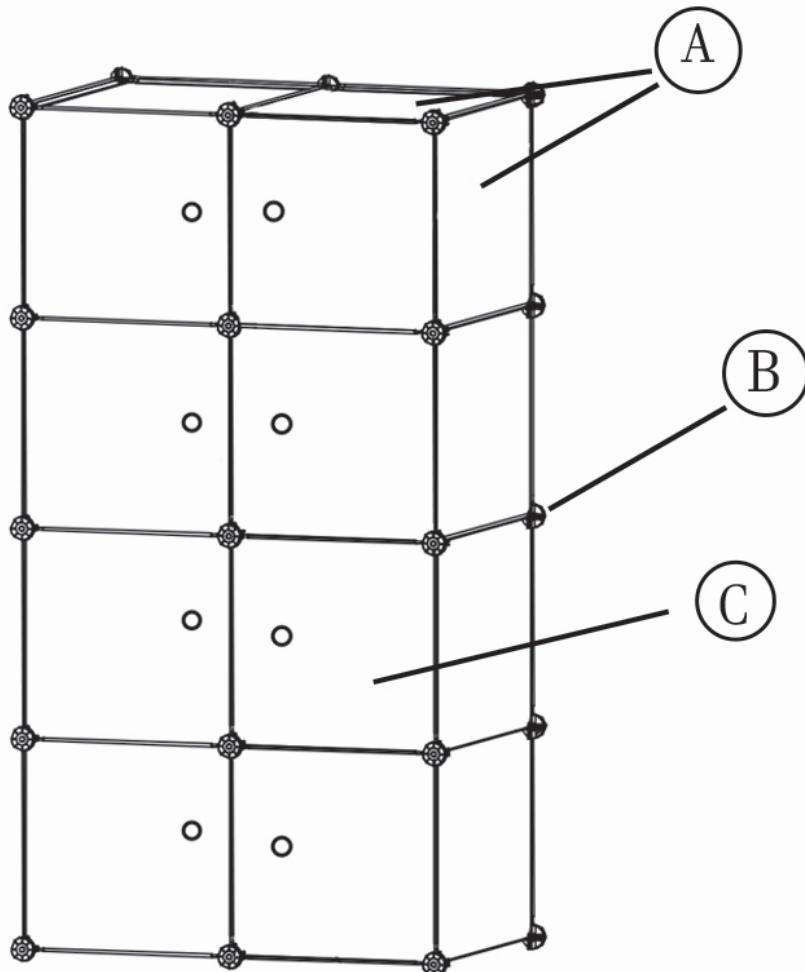
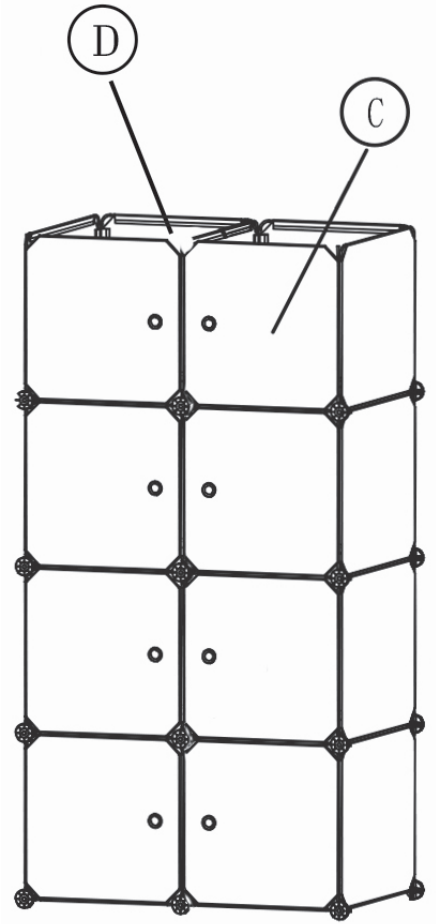

Done

F

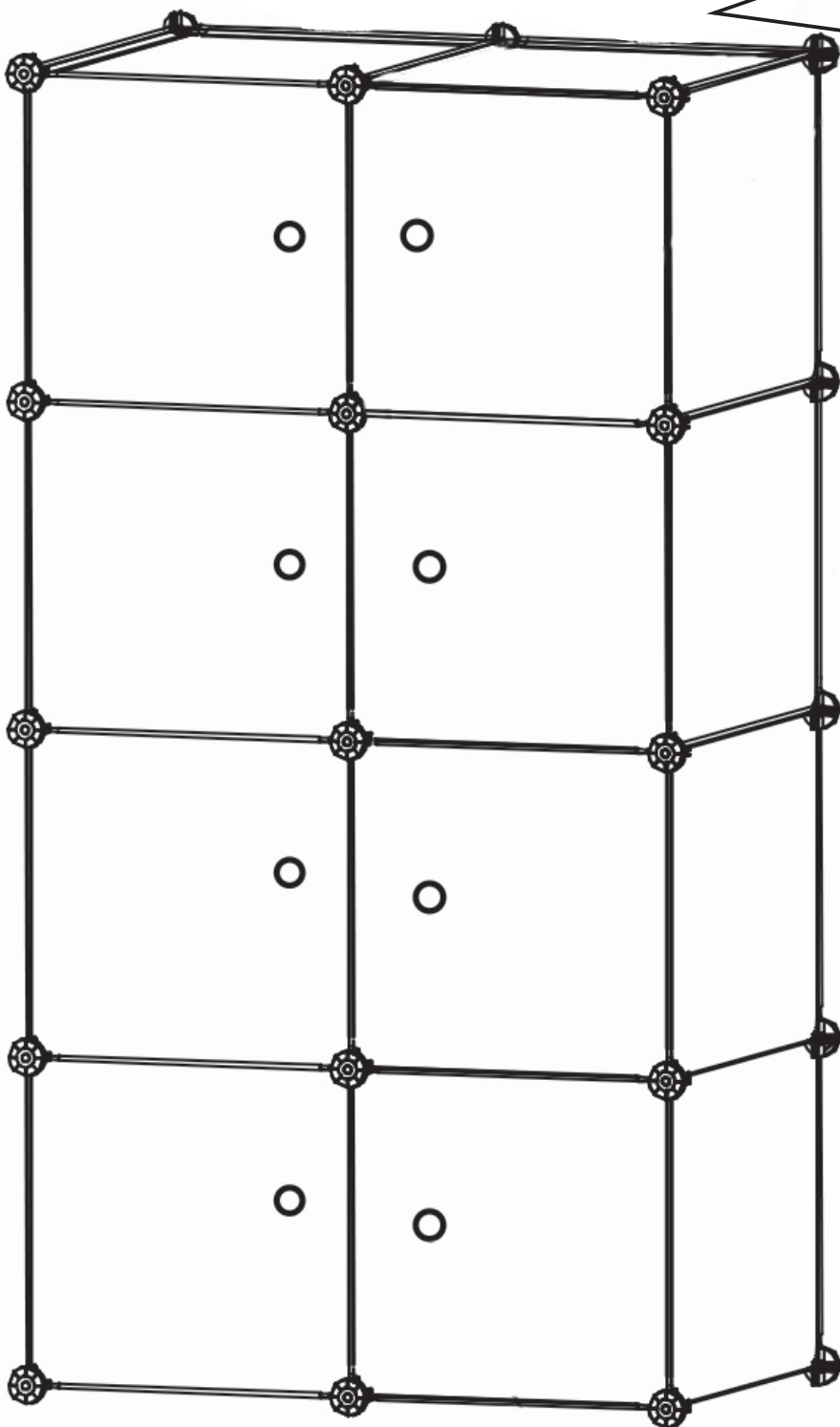
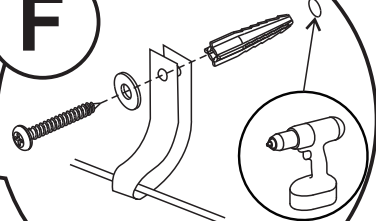

FR

**Pensez à
donner ou recycler.**



Association

ou



Magasin

ou



Déchèterie

<https://quefairedemesdechets.fr>