

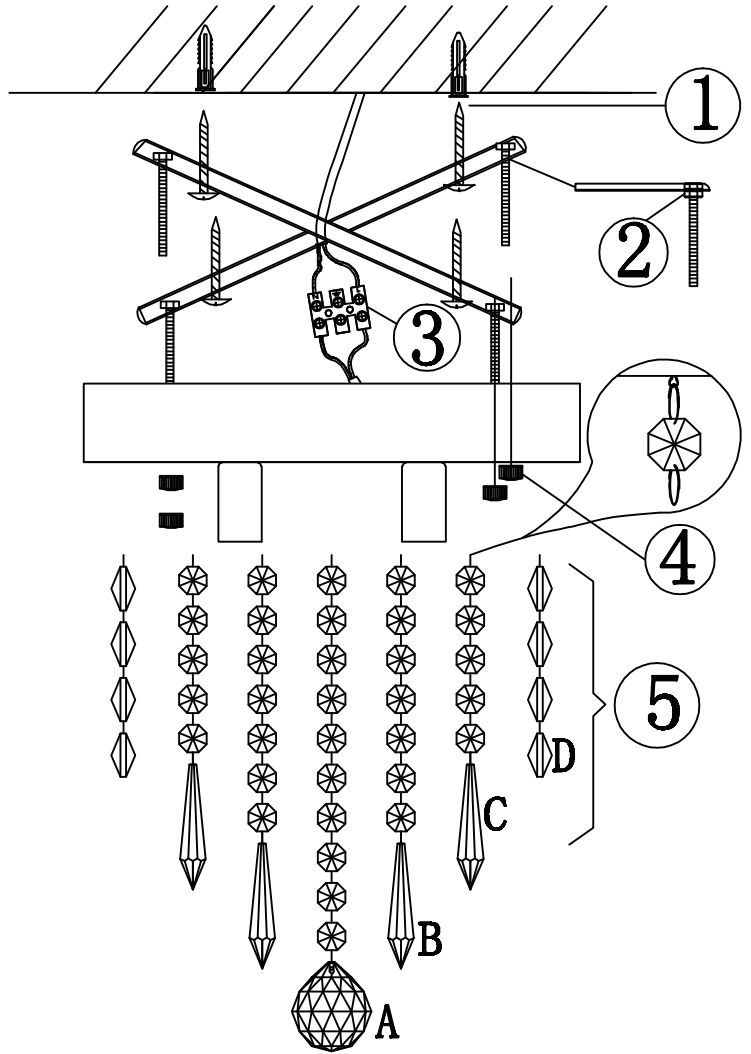

ASSEMBLY INSTRUCTION

INcna118_UK_FR_ES_DE_IT

B31-299

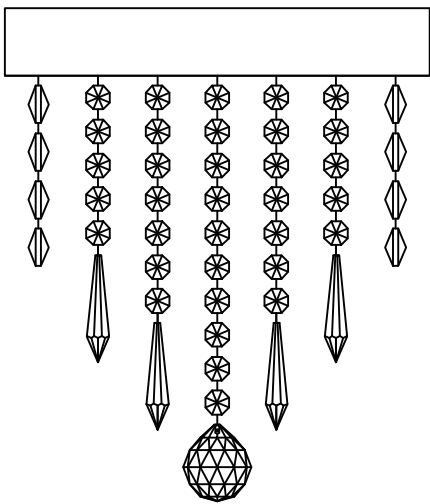
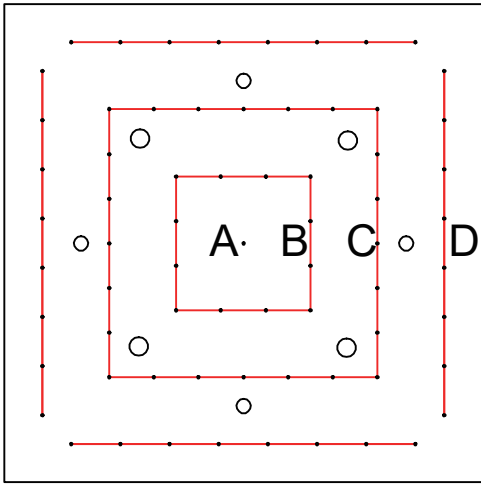

INSTALLATION STEPS

1. Turn off the power, and then mark the hanging holes on the ceiling.
2. Fix the lamp hanging plate on the expansion in the ceiling with self-tapping screws.
3. Fix the hanging ceiling board on the lamp hanging plate and tighten the screws on the knob. Hanging the crystal A-D one by one. Hang on from inside to outside.
4. Install the light bulb.
5. Turn on the power and regulate the lighting.



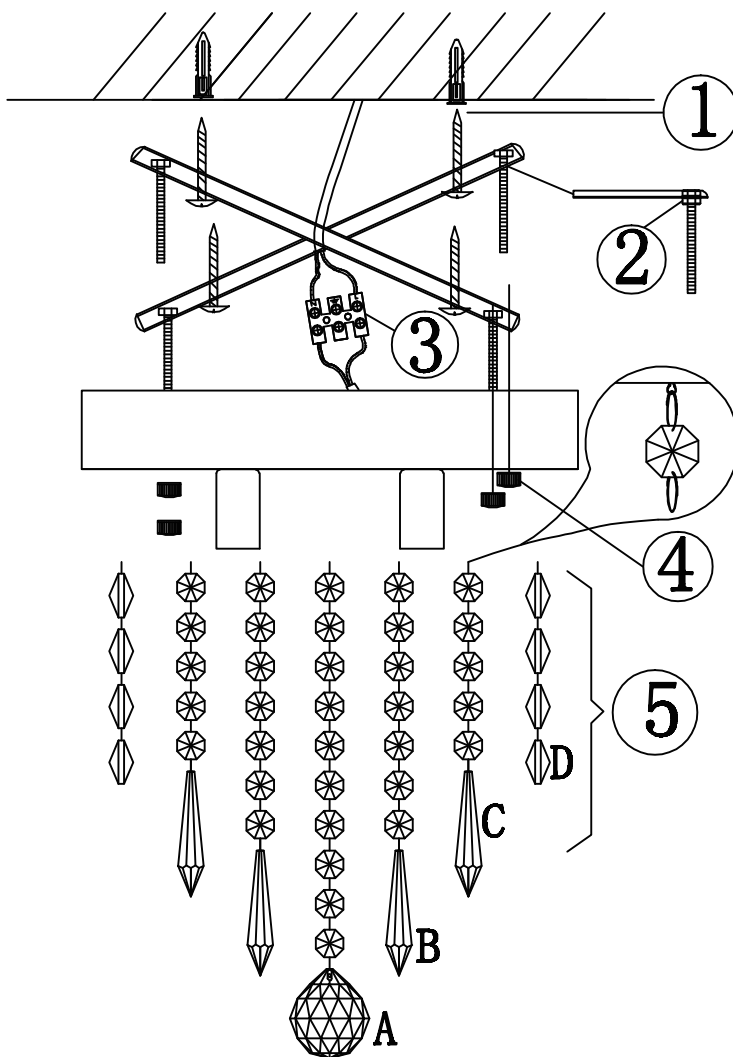
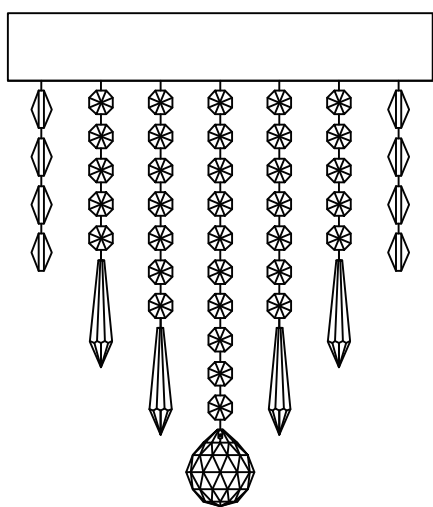
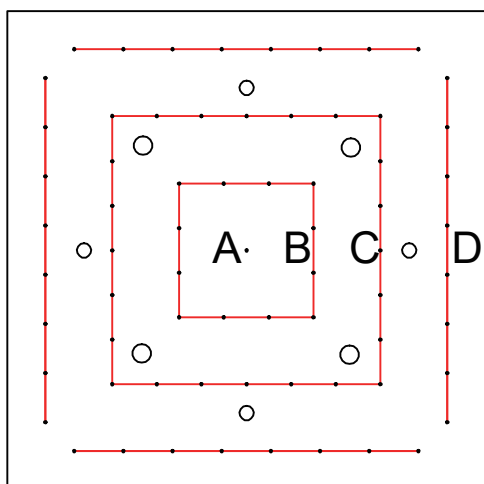

Part List	
Part name	QTY
Light source (Bulbs not included)	4
Stainless base	1
	1
	12
	24
	4
	4
	4
	1

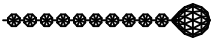
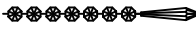
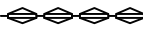

ETAPES DE L'INSTALLATION

1. Coupez l'alimentation, puis marquez les trous de suspension au plafond.
2. Fixez la plaque d'accrochage de la lampe sur l'expansion dans le plafond avec des vis autotaraudeuses.
3. Fixez la plaque de suspension au plafond sur la plaque de suspension de la lampe et serrez les vis sur le bouton. Accrochez les cristaux A-D un par un. Accrochez-les de l'intérieur vers l'extérieur.
4. Installez l'ampoule.
5. Allumez le courant et réglez l'éclairage.

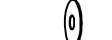



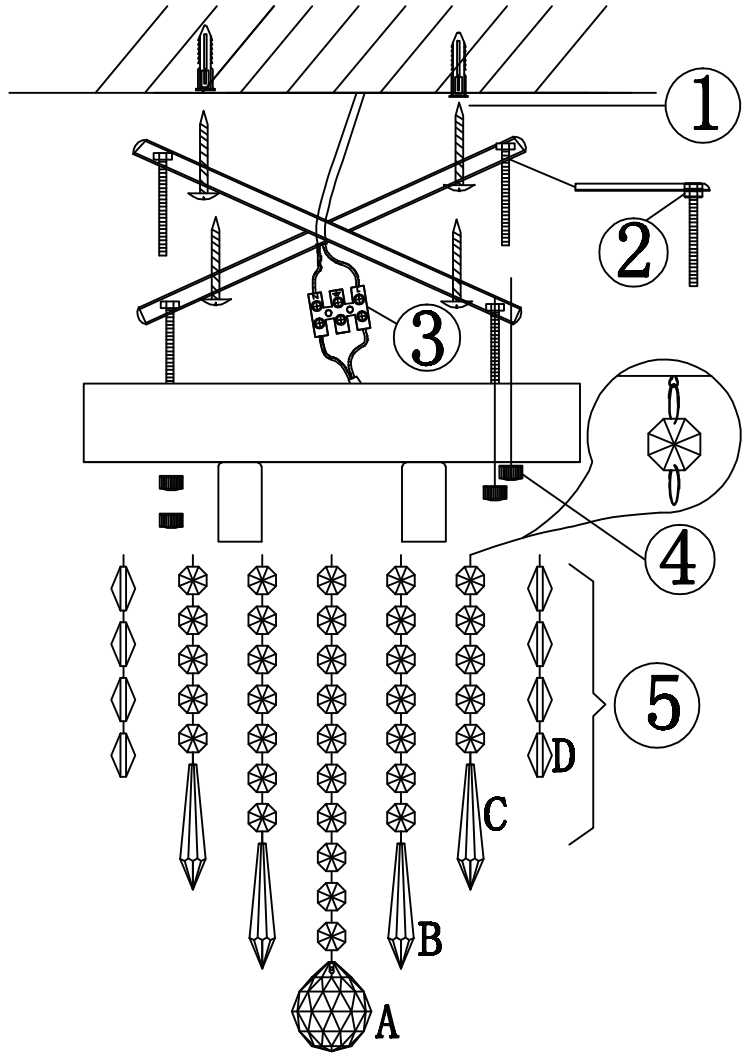
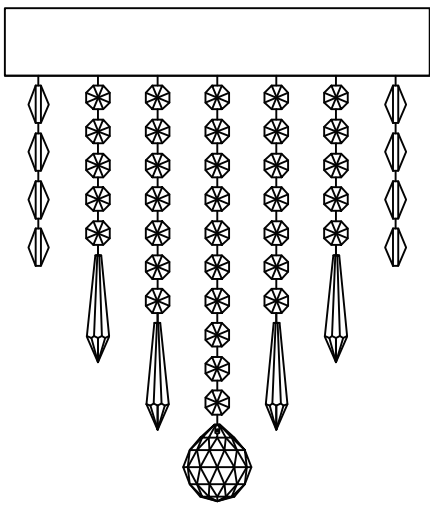
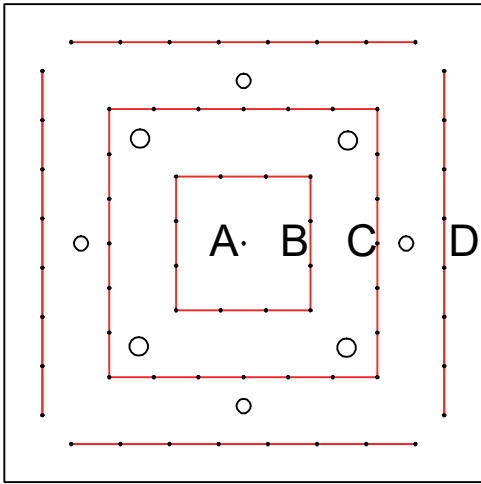

Liste des Pièces

Désignation	QTÉ
Source de lumière (Ampoules non incluses)	4
Base en acier inoxydable	1
	1
	12
	24
	4
	4
	4
	4
	1

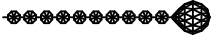

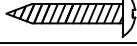
PASOS DE INSTALACIÓN



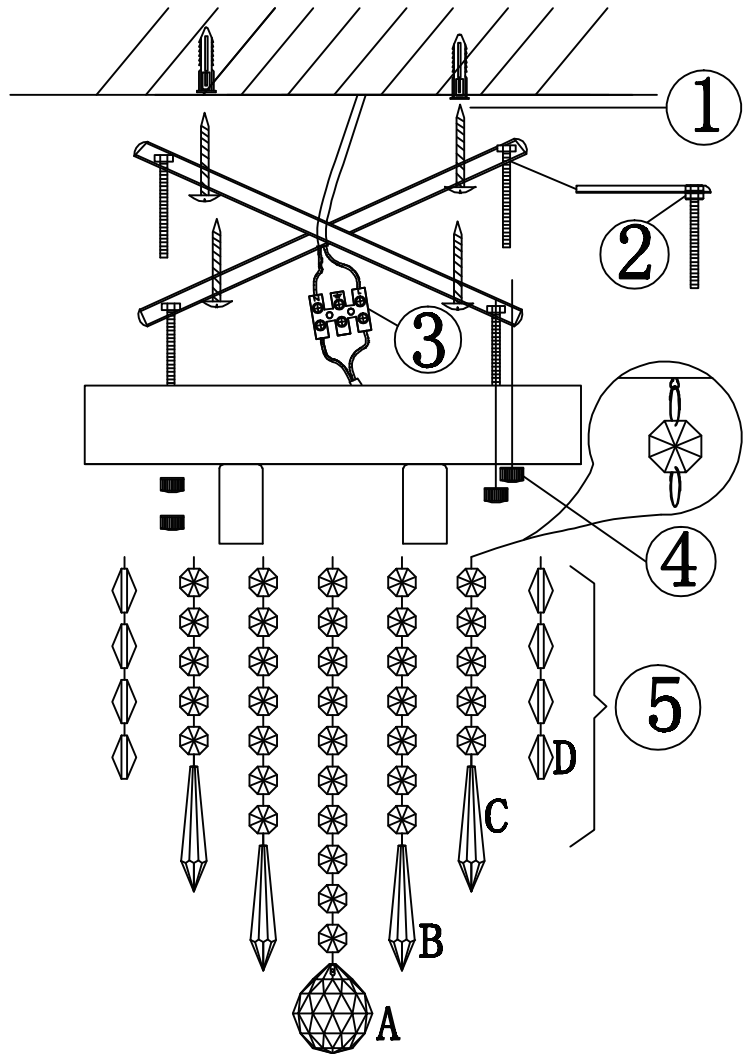
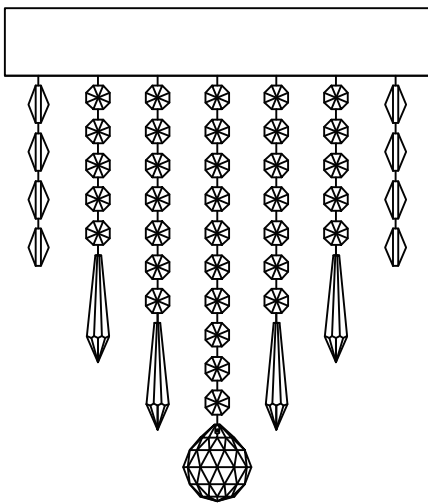
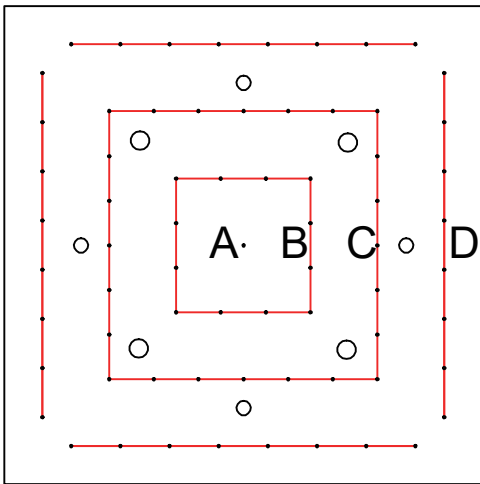

1. Apague la fuente de alimentación, luego marque los orificios para colgar en el techo.
2. Fije la placa para colgar la lámpara en la expansión del techo con los tornillos autorroscantes.
3. Fije la placa para colgar en el techo en la placa para colgar la lámpara, luego apriételas con los tornillos en la perilla. Cuelgue los cristales A-D uno a uno. Guélguelos de adentro hacia afuera.
4. Instale la bombilla en su lugar.
5. Enciende la energía y ajuste la iluminación.

Lista de piezas	
Nombre de la pieza	Cantidad
Fuente de luz (Bombillas no incluidas)	4
Base de acero inoxidable	1
	1
	12
	24
	4
	4
	4
	1

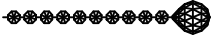

MONTAGESCHRITTE

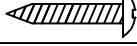
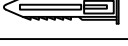
1. Schalten Sie den Strom aus, und markieren Sie dann die Aufhängelöcher an der Decke.
2. Befestigen Sie die Lampenaufhängeplatte mit Blechschrauben an der Erweiterung in der Decke.
3. Befestigen Sie die Aufhängeplatte an der Decke auf der Lampenaufhängeplatte und ziehen Sie die Schrauben am Knopf fest. Hängen Sie den Kristall A-D nacheinander auf. Hängen Sie ihn von innen nach außen auf.
4. Setzen Sie die Glühbirne ein.
5. Schalten Sie den Strom ein und regulieren Sie die Beleuchtung.



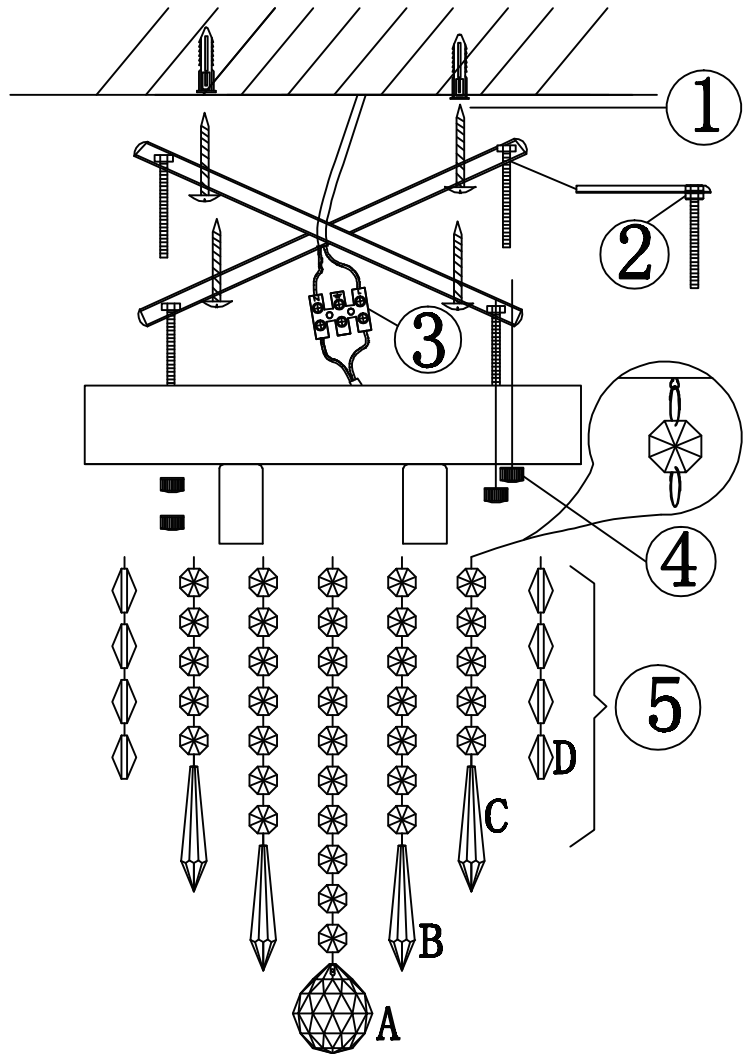
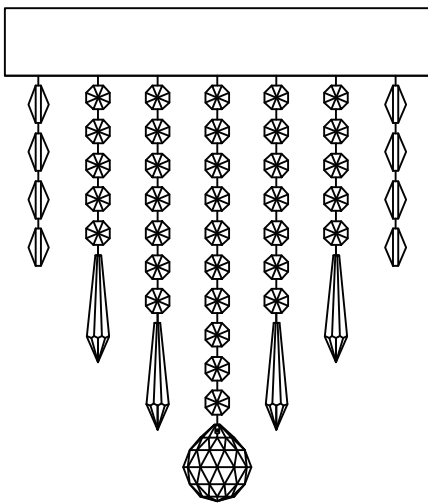
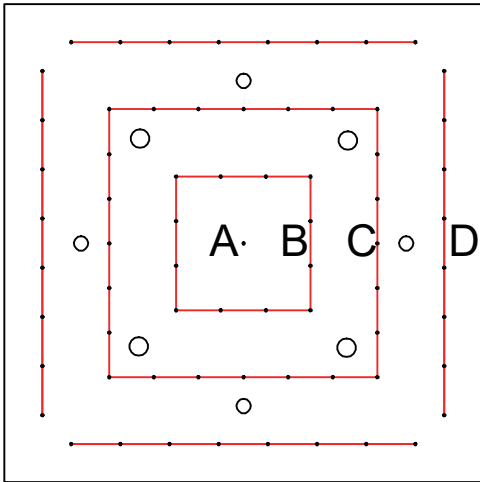



Stückliste	
Teile-Bezeichnung	Anzahl
Lichtquelle (Glühbirnen nicht enthalten)	4
Sockel aus Edelstahl	1
	1
	12
	24
	4
	4
	4
	1

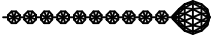

FASI DI INSTALLAZIONE

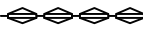
1. Spegnere l'alimentazione, e contrassegnare i fori di sospensione sul soffitto.
2. Fissare la piastra di sospensione della lampada sull'espansione a soffitto con viti autofilettanti.
3. Fissare il pannello del soffitto sospeso sulla piastra di sospensione della lampada e serrare le viti sulla manopola. Appendere il cristallo A-D uno ad uno. Appenderli dall'interno verso l'esterno.
4. Installare la lampadina.
5. Accendere l'alimentazione e regolare l'illuminazione.

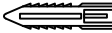
Lista delle Parti

Nomi delle parti	QTÀ
Fonte di luce (Lampadine non incluse)	4
Base in acciaio	1
	1
	12
	24
	4
	4
	4
	1

MH STAR UK LTD
Unit 27, Perivale Park, Horsenden lane South
Perivale, UB6 7RH
<https://www.aosom.co.uk>
Made in China

MH FRANCE
2 Rue Maurice Hartmann 92130 Issy Les Moulineaux
France
<https://www.aosom.fr>
Fabriqué en Chine

SPANISH AOSOM, S.L.
C. roc gros no.15, 08550 Els hostalets de Balenya, Spain B66295775
TEL: 931294512
<https://www.aosom.es>
Fabricado en China

MH Handel GmbH
Wendenstraße 309 D-20537 Hamburg
Germany
<https://www.aosom.de>
Hergestellt in China

AOSOM Italy srl
Centro Direzionale Milanofiori Strada 1 Palazzo F1 20090 Assago (MI)
P.I.: 08567220960
<https://www.aosom.it>
Prodotto in Cina

