



INcna137V01_UK_FR_IT

B31-396



Assembly video please scan the QR code .



IMPORTANT, RETAIN FOR FUTURE REFERENCE: READ CAREFULLY

ASSEMBLY & INSTRUCTION MANUAL

EN

1-Protection class I: The fitting has an earthing connection: The earth wire (yellow /green) has to be connected to the clip

marked with .

2-This fitting should only be installed in rooms where direct contact with water is impossible.

3-Consumption in w, according to the speed of the motor.

4-May be operated with a remote control.

WARNINGS

- Read entire booklet carefully before beginning installation and save these instructions.
- To reduce the risk of personal injury, attach the fan directly to the support structure of the building according to these instructions, and use only the hardware supplied.
- To avoid possible electrical shock, before installing your fan, disconnect the power by turning off the circuit breakers to the outlet box and associated wall switch location.
- All wiring must be in accordance with national and local electrical codes. If you are unfamiliar with wiring, you should use a qualified electrician.
- To reduce the risk of personal injury, do not bend the blade attachment the system when installing, balancing or cleaning the fan. Never insert foreign objects between rotating fan blades.
- To reduce the risk of fire, electrical shock or motor damage, do not lift or carry the fan by the lead wires.
- Ensure that when mounting the ceiling fan that the fixing can support the moving weight of the fan which is 15.8kg(35lb) minimum.
- The fan blades cannot be installed lower than 2.3m from the floor.

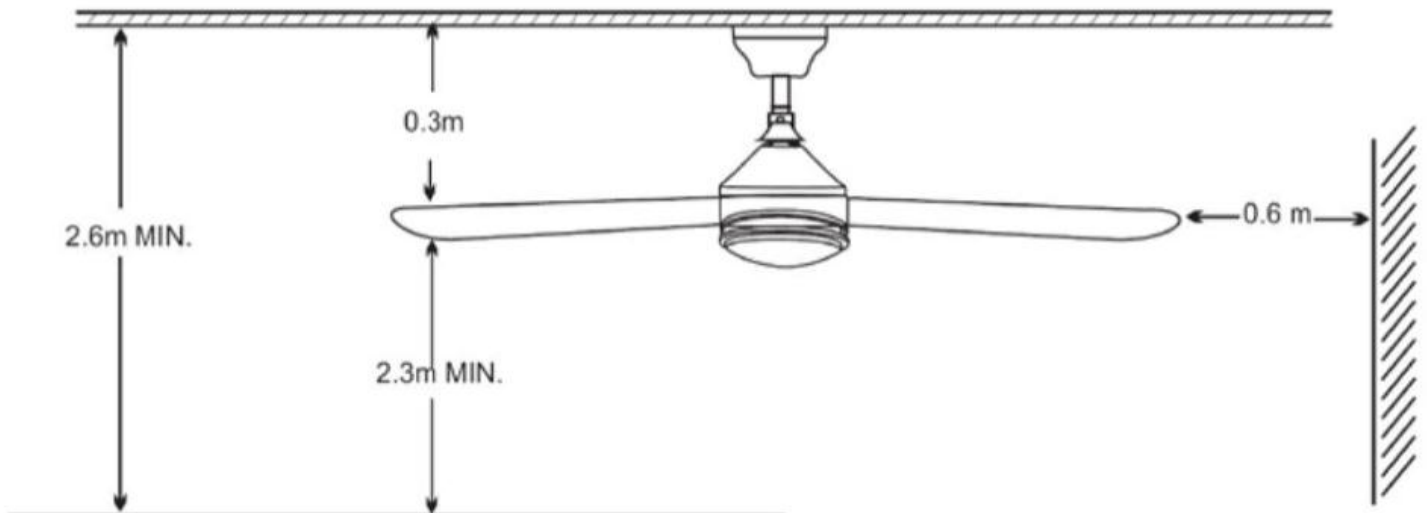

NOTE:

The important precautions, safeguards and instructions appearing in this manual are not meant to cover all possible conditions and situations that may occur. It must be understood that common sense, caution and carefulness are factors which cannot be built into this product. These factors must be supplied by the person(s) installing, caring for and operating the unit.

IMPORTANT SAFETY PRECAUTIONS

To ensure the success of installation, be sure to read instructions and check parts for completeness before starting.

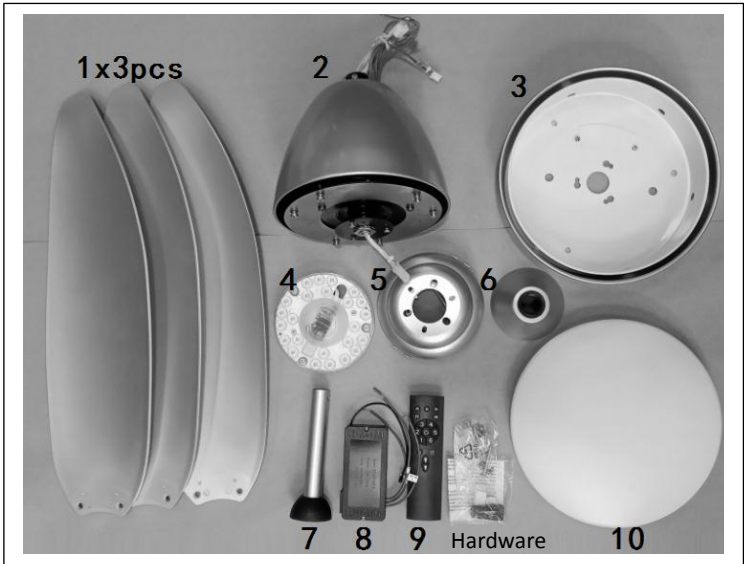
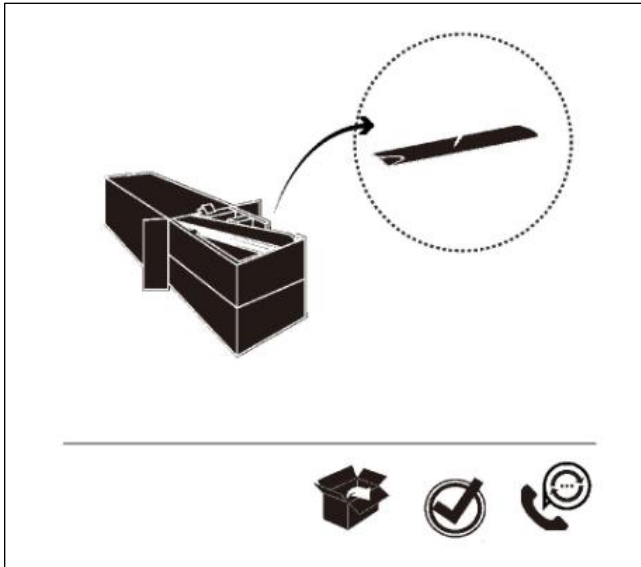

Hardware List

Ax2pcs



Φ6X40

Bx2pcs



ST4. 8*38

Cx7pcs



1/4-20*17

Dx2pcs



SM4*20

NOTE:

To reduce the risk of personal injury, only use the mounting kit provided with this ceiling fan.

TOOLS REQUIRED

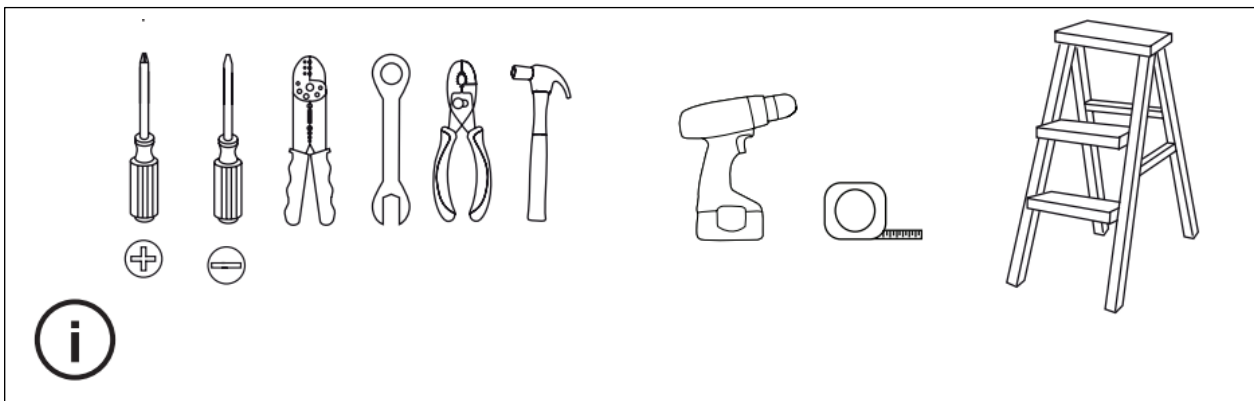

Be sure to turn off the power before preparing for installation



PREPARING FOR MOUNTING

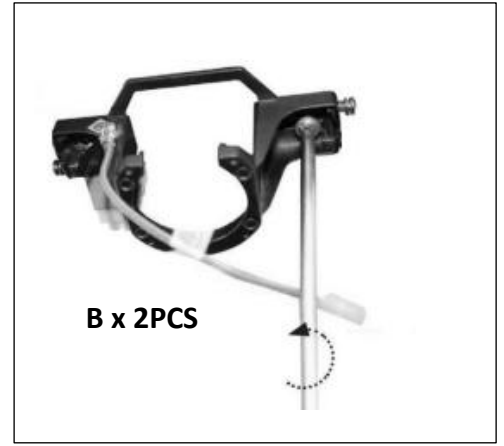
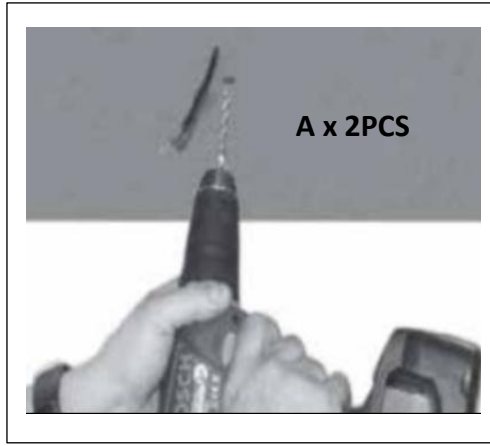

1. Remove the canopy from the mounting bracket, install the mounting bracket to the ceiling. (please ensure the fixing is able to support minimum moving weight of the fan which is 15.8kg=35Lb)

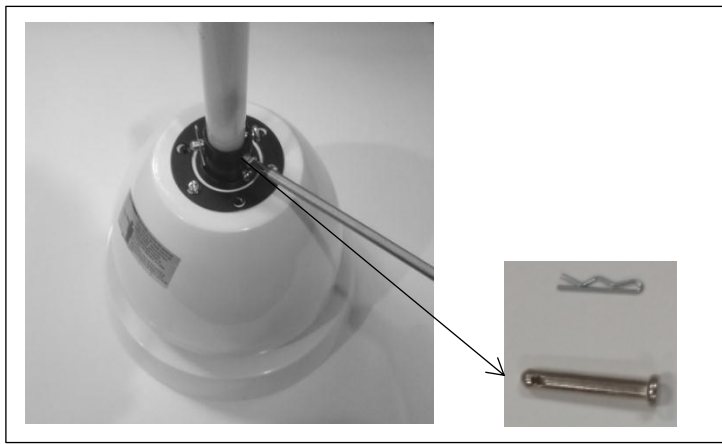
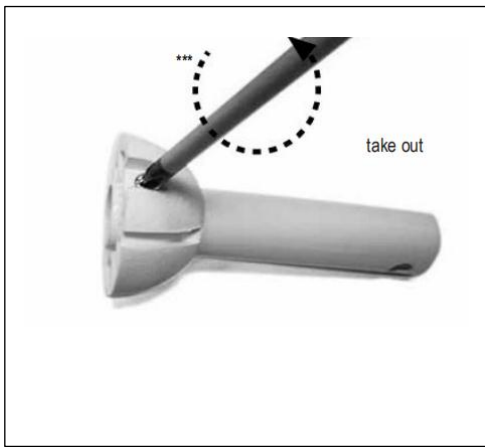

2. Remove the nylon ball from the down rod and push the pin and clevis from the motor assembly, pass the wires through the down rod and reinsert the pin and clevis, tighten the screw holding the down rod in place.

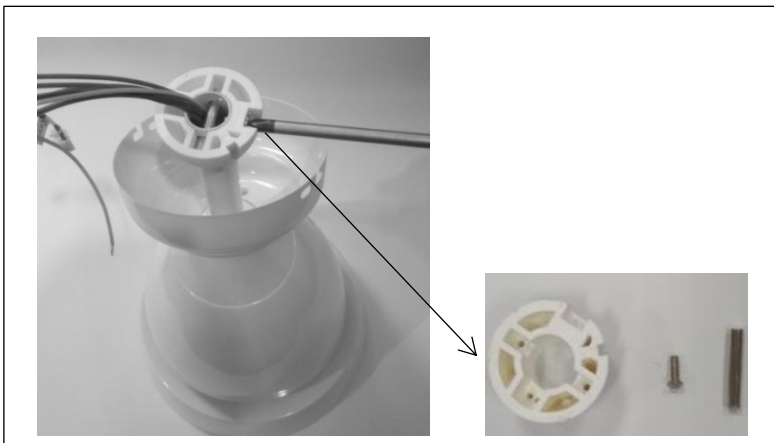

3. Put the yoke cover and canopy through the down rod, reinsert the nylon ball, pin and screw on the down rod.

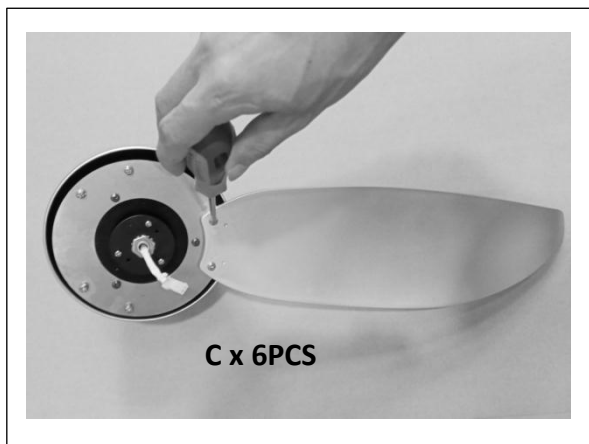

4. Install the fan blades. Be sure to tighten the screws.

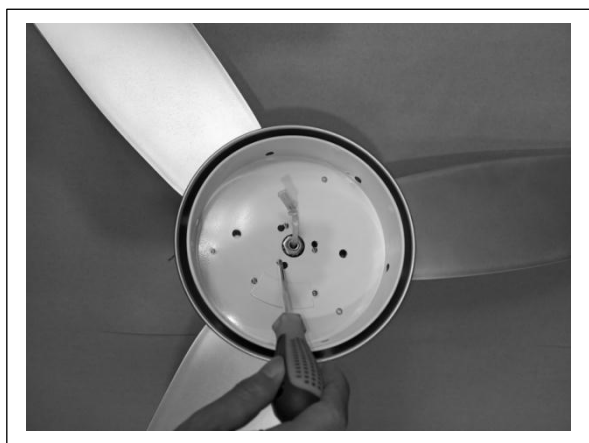

5. Install the light kit pan to the motor assembly by tighten the screws.



6. Connect two plugs to connect the LED plate to the entire motor. Place the LED in the center of the panel.

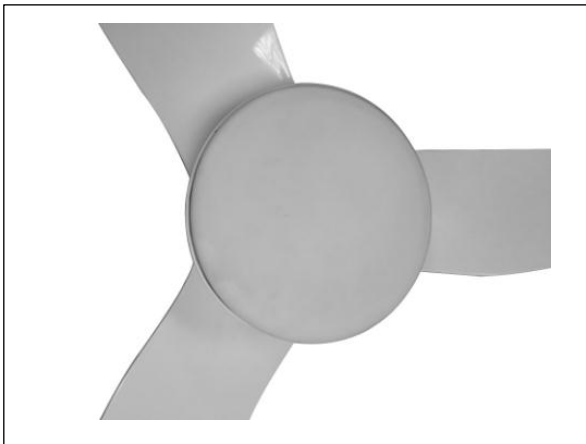

7. Turn the glass bowl clockwise until it stops.

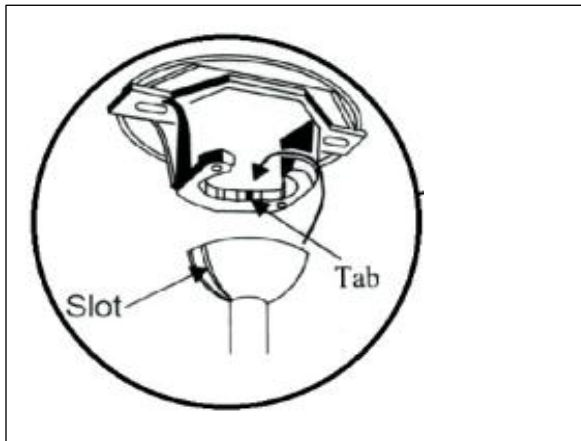
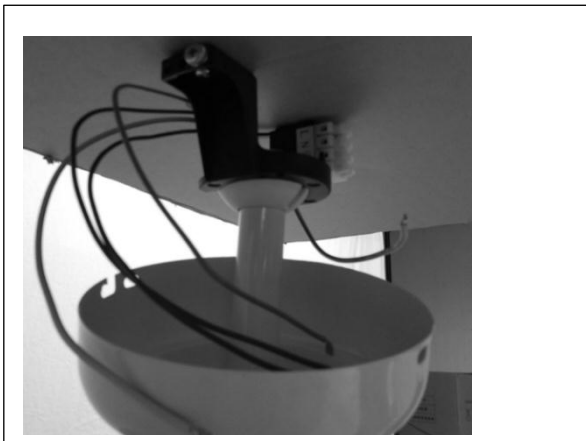

8. Lift the fan up and place the nylon ball onto the bracket, Make sure the guide pin of the bracket fits into the slot of the ball.

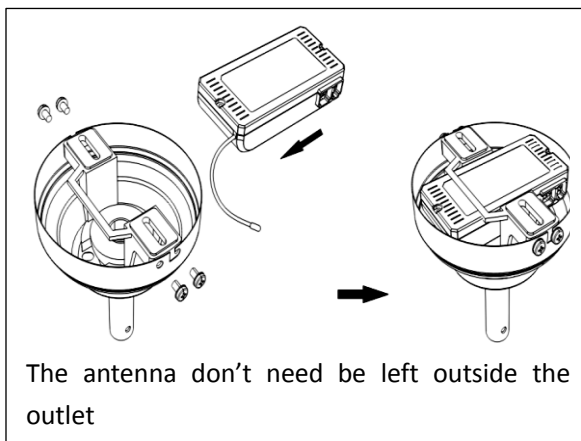
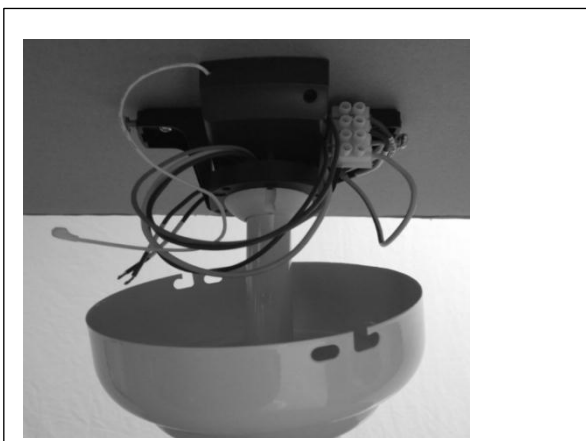

9. put the remote receiver into the middle of the bracket and connect the wires. (connect the wires according to the wiring instructions)

power supply from ceiling (230V/50Hz)

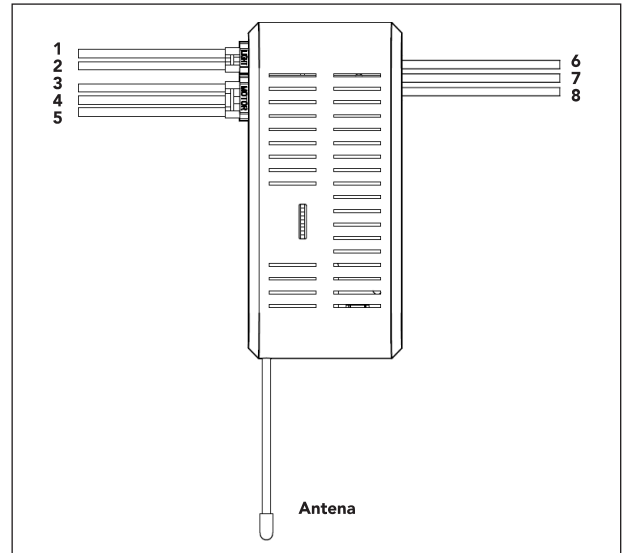
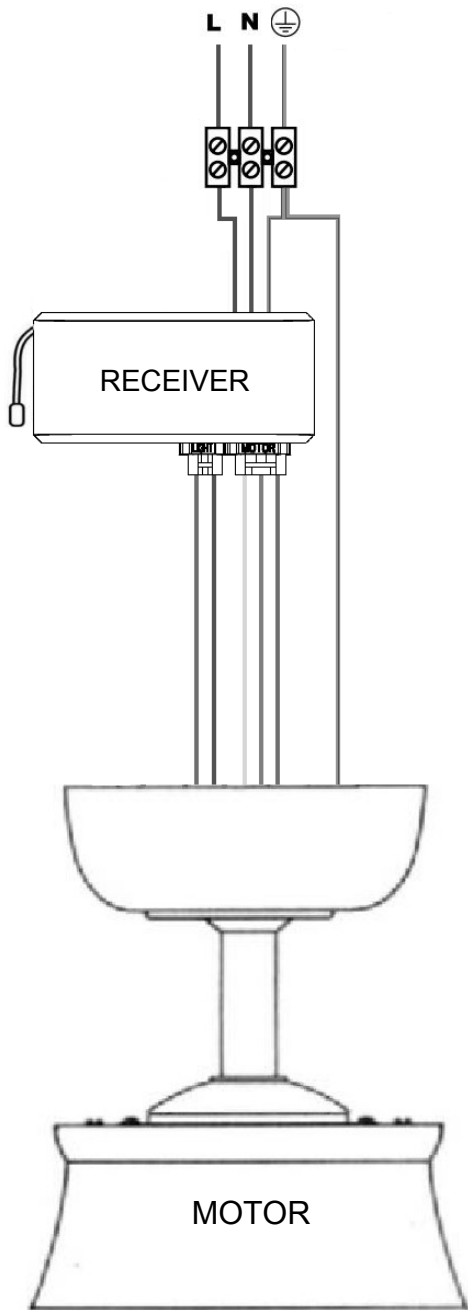

Subtitle:

- 1: Light wire L (Red)
- 2: Light wire N (Blue)
- 3: Motor phase wire U (Gray)
- 4: Motor phase wire V (Yellow)
- 5: Motor phase wire W (Red)
- 6: AC IN L (Brown)
- 7: AC IN N (Blue)
- 8: Ground wire (Green & Yellow)

10. Remote control connection diagram.



11. Assemble the canopy with the bracket again and using the fixing screws to tighten the canopy, make sure that the canopy is secured and that you have not trapped any wires.

REMOTE CONTROL

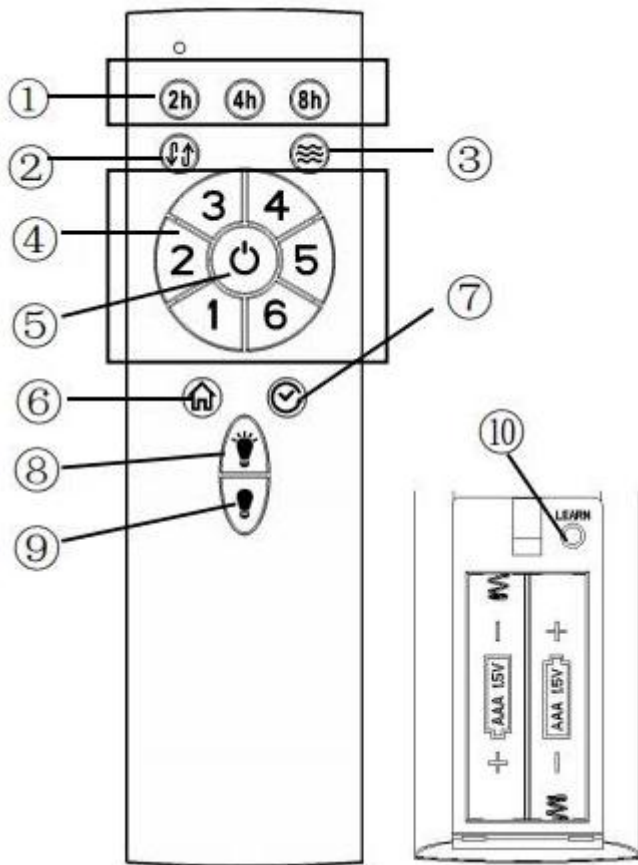

- ① Timer function: fan and light can set timer 2 hours/4 hours / 8 hours to turn off . (When both the light and the fan are off, the light and fan are automatically turned on and then activate timer function).
- ② Direction forwarding and reversing of fan.
- ③ Comfort Breeze : The fan will cycle randomly from speed 2 to speed 5.
- ④ Fan speed: control the fan speed 1~6 separately
- ⑤ Power switch: control fan ON or OFF
- ⑥ Home shield light: When starting, the fan is turned off, and the light flashes 2 times and then circulates in A-B-A mode:
A. Turn on 5-20 minutes at random.
B. Turn off 60 minutes.
- ⑦ Delay off function: the fan and light will off after 1 minute.
- ⑧ Light: ON
- ⑨ Light: OFF
- ⑩ Learn key: Tap to activate learning code pairing

Using 2pcs of AAA 1.5V batteries.

IMPORTANTE

1. When the transmitter cannot control the receiver, please check whether the battery switch contact is normal, whether the positive and negative poles are placed correctly, and whether the battery is sufficient. If the battery voltage is too low, it will affect the transmitting intensity and cause remote control failure. Please replace the battery in time.
2. When the transmitter cannot control the receiver, please check if there are similar products nearby. The simultaneous transmission of radio waves by the same kind remote control products will cause interference to each other and affect the receiving effect.
3. The battery will decrease in power over time. Please replace the battery before it leaks to avoid damage to the transmitter. Please handle the used battery properly. Keep the battery out of the reach of children.
4. If you do not use it for a long time, please remove the batteries from the transmitter.

Care and Cleaning



WARNING: Make sure the power is off before cleaning your fan.

- Because of the fan's natural movement, some connections may become loose. Check the support connections, brackets, and blade attachments twice a year. Make sure they are secure. It is not necessary to remove the fan from the ceiling.
- Clean your fan periodically to help maintain its new appearance over the years. Do not use water when cleaning, as this could damage the motor, or the wood, or possibly cause an electrical shock. Use only a soft brush or lint-free cloth to avoid scratching the finish. The plating is sealed with a lacquer to minimize discoloration or tarnishing.
- You can apply a light coat of furniture polish to the wood for additional protection and enhanced beauty. Cover small scratches with a light application of shoe polish.
- You do not need to oil your fan. The motor has permanently-lubricated sealed ball bearings.

Troubleshooting

Problem	Solution
The fan will not start.	<ul style="list-style-type: none"><input type="checkbox"/> Check the main and branch circuit fuses or breakers.<input type="checkbox"/> Check the line wire connections to the fan and switch wire connections in the switch housing.
The fan is noisy.	<ul style="list-style-type: none"><input type="checkbox"/> Ensure all motor housing screws are snug.<input type="checkbox"/> Ensure the screws that attach the blade bracket to the motor hub are tight.<input type="checkbox"/> Ensure the wire nut connections are not rattling against each other or the interior wall of the switch housing.<input type="checkbox"/> Allow a 24-hour "breaking in" period. Most noises associated with a new fan disappear during this time.<input type="checkbox"/> If you are using the Ceiling Fan light kit, ensure the screws securing the glassware are tight. Check that the light bulbs are also secure.<input type="checkbox"/> Ensure the canopy is a short distance from the ceiling. It should not touch the ceiling.<input type="checkbox"/> Ensure your outlet box is secure and rubber isolator pads were used between the mounting plate and outlet box.
The fan wobbles.	<ul style="list-style-type: none"><input type="checkbox"/> Check that all blade and blade arm screws are secure.<input type="checkbox"/> Most fan wobble problems are caused when blade levels are unequal. Check this level by selecting a point on the ceiling above the tip of one of the blades. Measure from a point on the center of the blade to the point on the ceiling. Rotate the fan until the next blade is positioned for measurement, and measure from the same point on each blade to the ceiling. Repeat for each blade. Any measurement deviation should be within 1/8 in. Run the fan for ten minutes. If the fan continues to wobble please contact Customer Service and a balancing kit will be sent to you at no charge.

EN: This product contains a light source of energy efficiency class <F>.

FR

1-Classe de protection I : Le raccord est doté d'une connexion de mise à la terre : Le fil de terre (jaune /vert) doit être connecté au clip marqué avec .

2- Installez le produit uniquement dans des pièces sèches et tenez-le à l'écart des substances humides.

3-La consommation de la vitesse du moteur est en Watts.

4-Possibilité de fonctionnement avec une télécommande.

AVERTISSEMENTS

- Lisez attentivement ce manuel avant de procéder à l'installation et conservez-le pour référence ultérieure.
- Pour prévenir tout risque de blessure, fixez le ventilateur directement à la structure de support du bâtiment en suivant ces instructions. N'utilisez que le matériel fourni.
- Pour prévenir tout risque d'électrocution, avant d'installer votre ventilateur, coupez l'alimentation électrique en fermant les disjoncteurs de la boîte de sortie et des interrupteurs muraux.
- Tout le câblage doit être conforme aux codes électriques nationaux et locaux. Si vous n'êtes pas familier avec le câblage, contactez un électricien qualifié.
- Pour prévenir tout risque de blessure, ne pliez pas les pales lors de l'installation ou du nettoyage du ventilateur. N'insérez jamais d'objets entre les pales du ventilateur en rotation.
- Pour prévenir les risques d'incendie, d'électrocution ou de dommages au moteur, ne soulevez pas et ne portez pas le ventilateur par les câbles.
- Lors de l'installation du ventilateur, assurez-vous que le plafond peut supporter le poids, qui est d'au moins 15,8 kg (35lbs).
- Les pales du ventilateur ne peuvent pas être installées à moins de 2,3 m du sol.

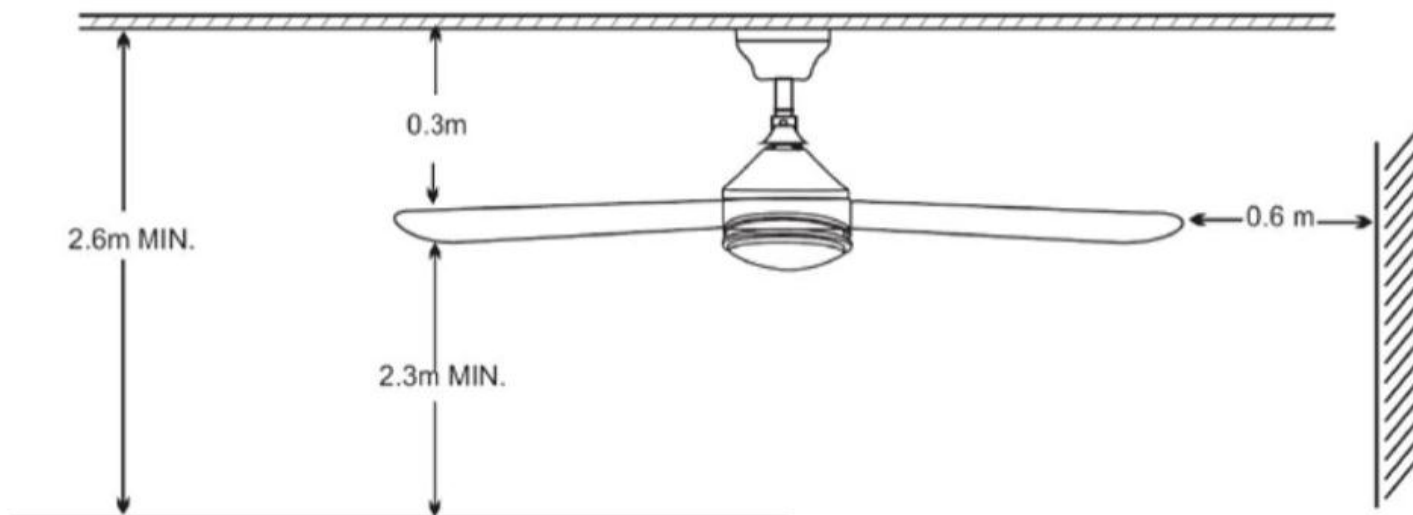

NOTE :

Les mesures importantes de précaution, de protection et d'instruction figurant dans ce manuel ne sont pas censées couvrir toutes les conditions et situations possibles qui peuvent se produire. Il faut comprendre que le bon sens, la prudence et la précaution sont des facteurs qui doivent être aussi pris en considération. Ces facteurs doivent être pris en compte par la ou les personnes qui installent, entretiennent et utilisent l'appareil.

CONSIGNES IMPORTANTES DE SÉCURITÉ

Lisez les instructions et vérifiez que toutes les pièces sont présentes avant de commencer.

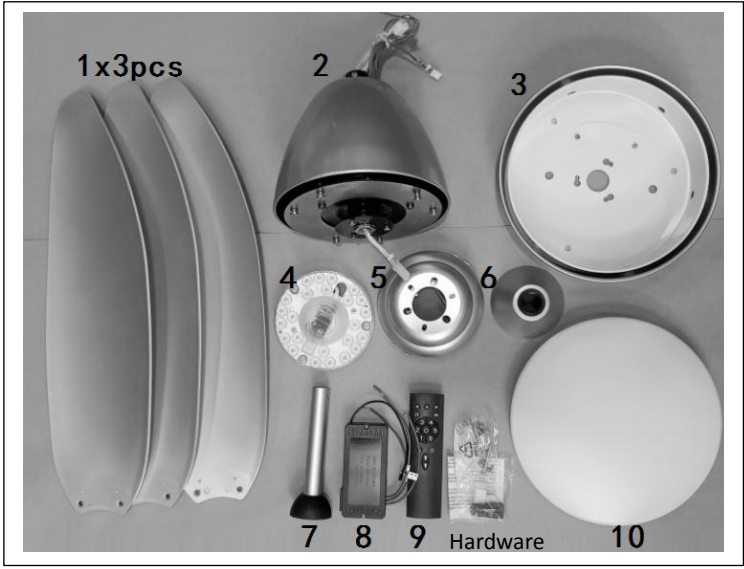
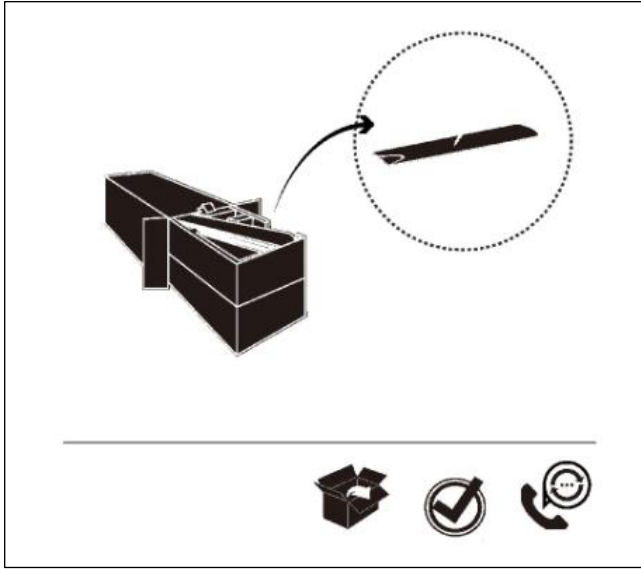

Hardware List

Ax2pcs



Φ6X40

Bx2pcs



ST4. 8*38

Cx7pcs



1/4-20*17

Dx2pcs



SM4*20

NOTE :

Pour prévenir tout risque de blessure, utilisez le kit fourni.

OUTILS REQUIS

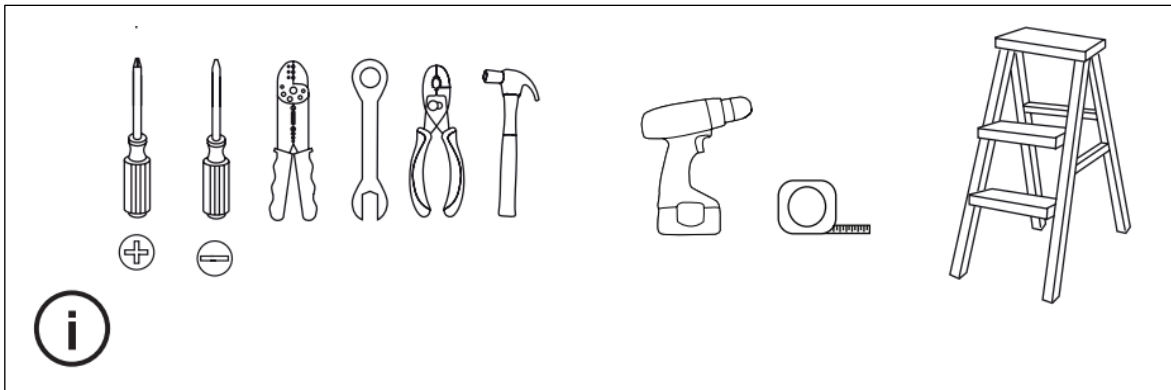

Couper l'alimentation électrique avant de procéder à l'installation.

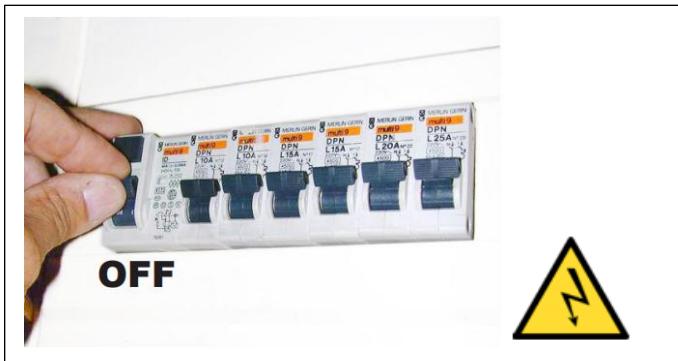

PRÉPARATION AU MONTAGE

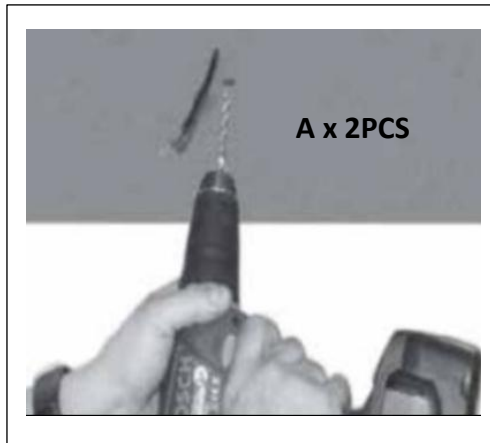

1. Retirez le capot du support de montage et installez le support de montage au plafond. Assurez-vous que le plafond peut supporter le poids minimum du ventilateur, qui est de 15,8 kg ou 35 lb.

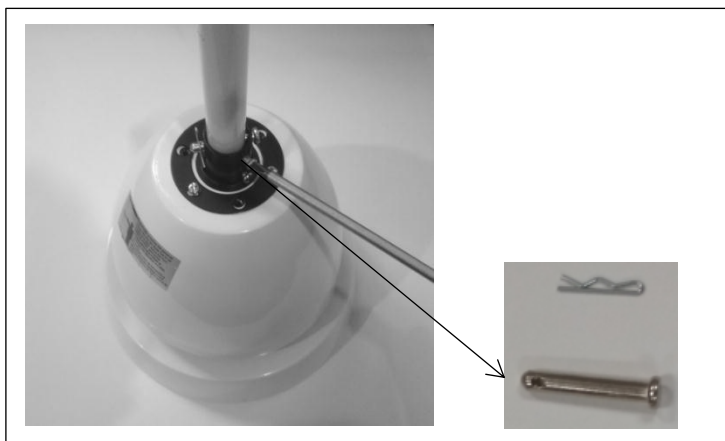
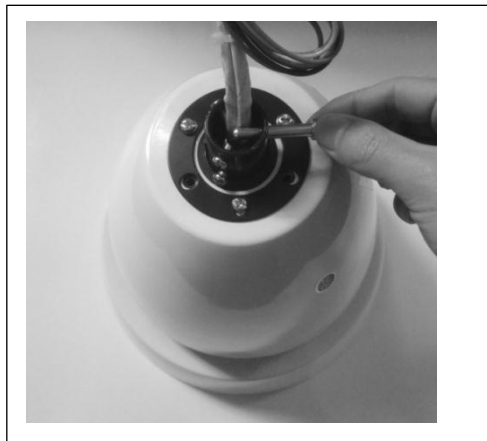
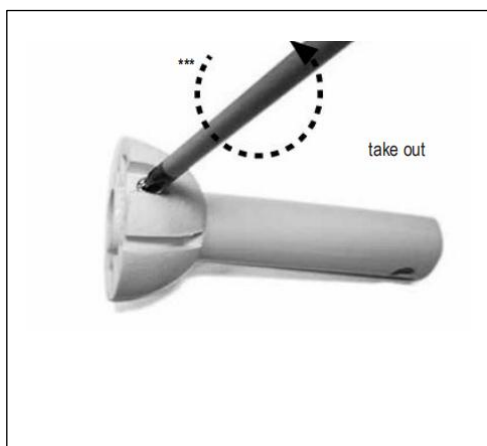

2. Retirez la boule en nylon de la tige de descente et retirez l'axe et la chape du moteur. Faites passer les câbles dans la tige descendante et réinsérez l'axe et la chape. Serrez la vis qui maintient la tige descendante en place.

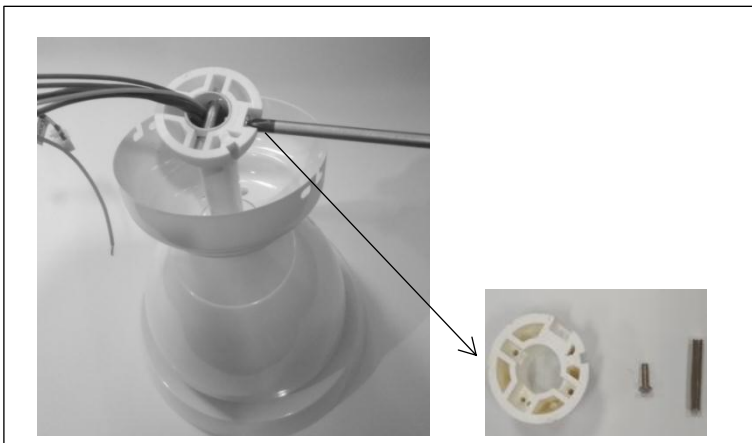

3. Placez le couvercle de l'étrier et le capot dans la tige descendante. Réinsérez la boule en nylon, la goupille et la vis dans la tige descendante.

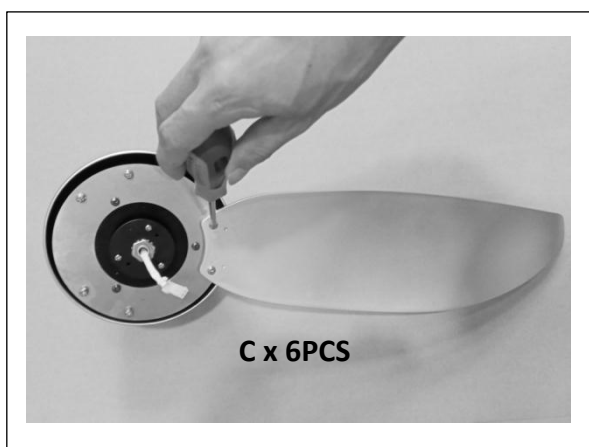

4. Installez les pales du ventilateur. Assurez-vous que les vis sont bien serrées.

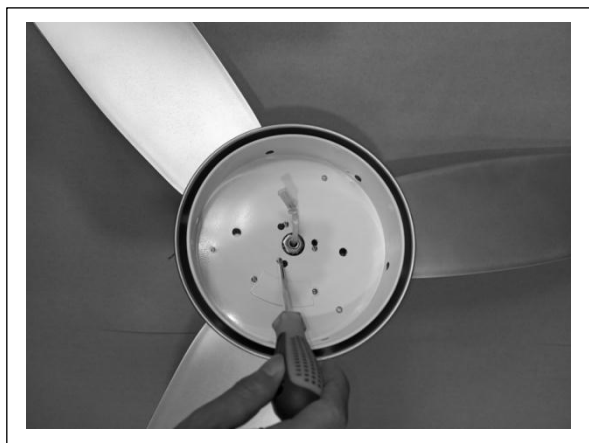

5. Installez le plateau du kit d'éclairage sur l'ensemble du moteur en serrant les vis.

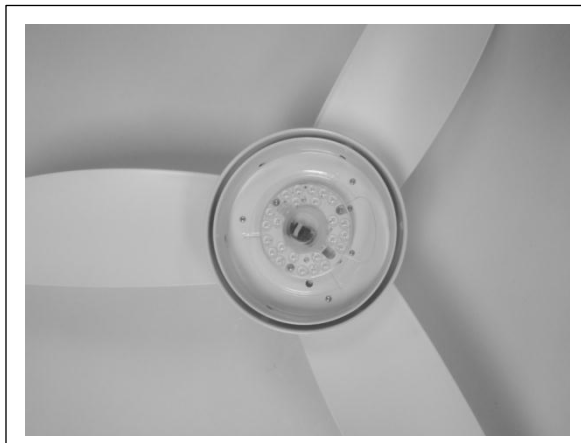

6. Connectez deux fiches pour relier la plaque de LED à l'ensemble du moteur. Placez la DEL au centre de la plaque.

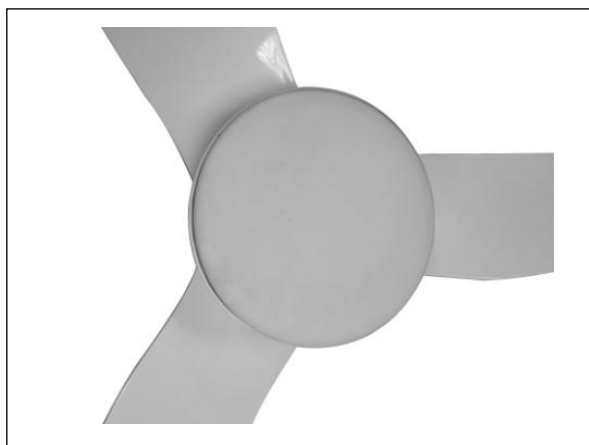

7. Tournez le bol en verre dans le sens des aiguilles d'une montre jusqu'à ce qu'il s'arrête.

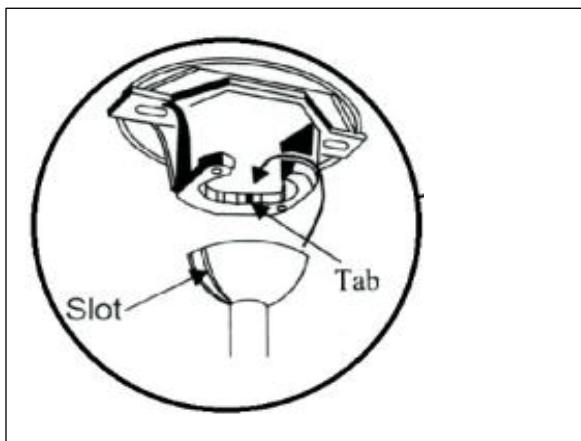
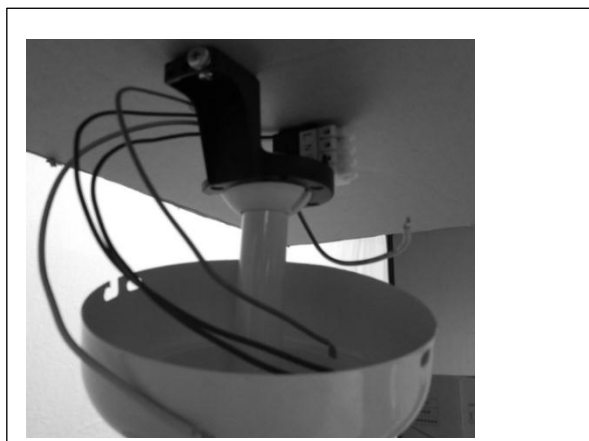

8. Soulevez le ventilateur et placez la boule en nylon sur le support. Assurez-vous que la tige de guidage du support s'insère dans la fente de la boule.

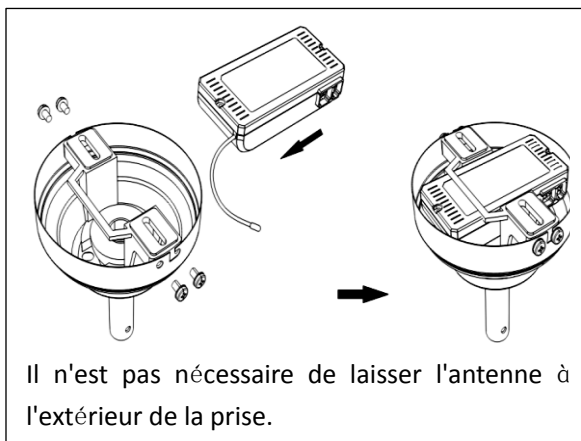
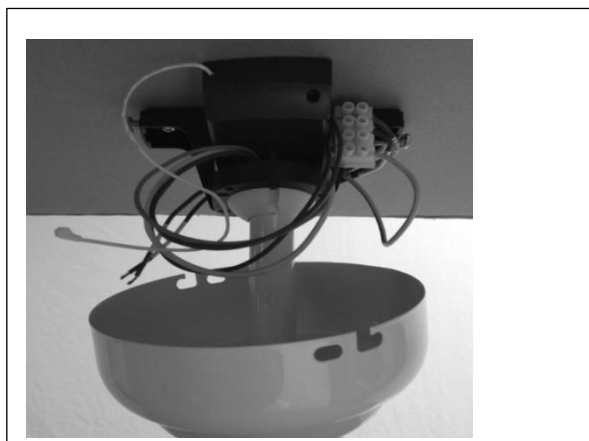

9. Mettez le récepteur de la télécommande au milieu du support et connectez les câbles selon les instructions.

Alimentation depuis le plafond (230V/50Hz)

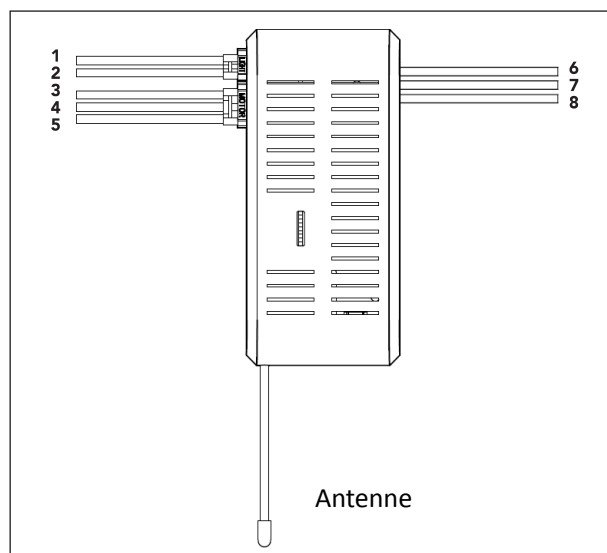
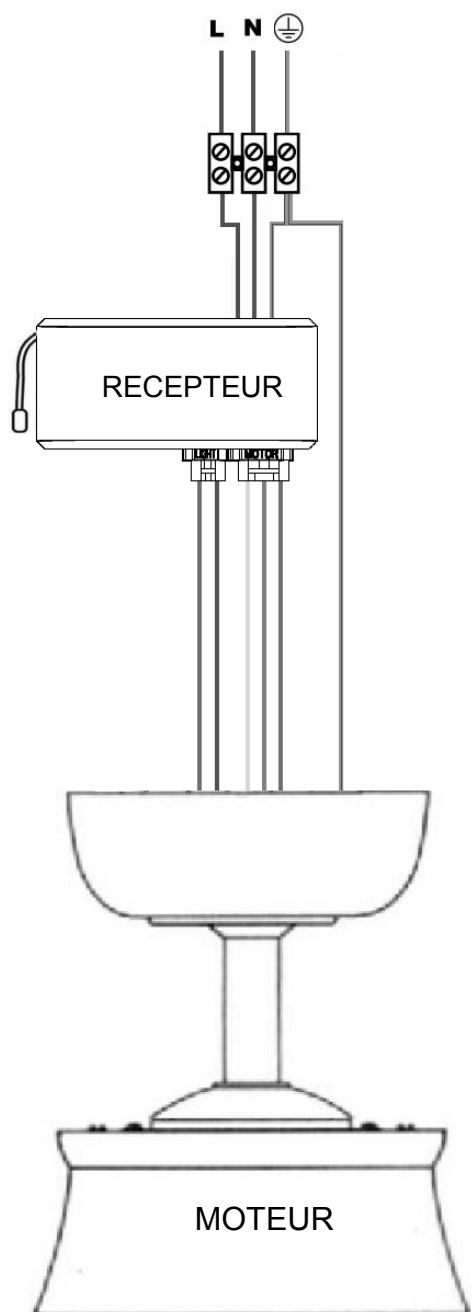

Sous-titre :

- 1 : Fil de lumière L (rouge)
- 2 : Fil d'éclairage N (bleu)
- 3 : Fil de phase moteur U (Gris)
- 4 : Fil de phase du moteur V (jaune)
- 5 : Fil de phase moteur W (Rouge)
- 6: AC IN L (Marron)
- 7: AC IN N (Bleu)
- 8: Fil de terre (vert et jaune)

10. Schéma de connexion de la télécommande.



11. Remontez le capot avec le support. Utilisez les vis de fixation pour serrer le capot, assurez-vous qu'il est bien fixé et qu'il n'y a pas de câbles coincés.

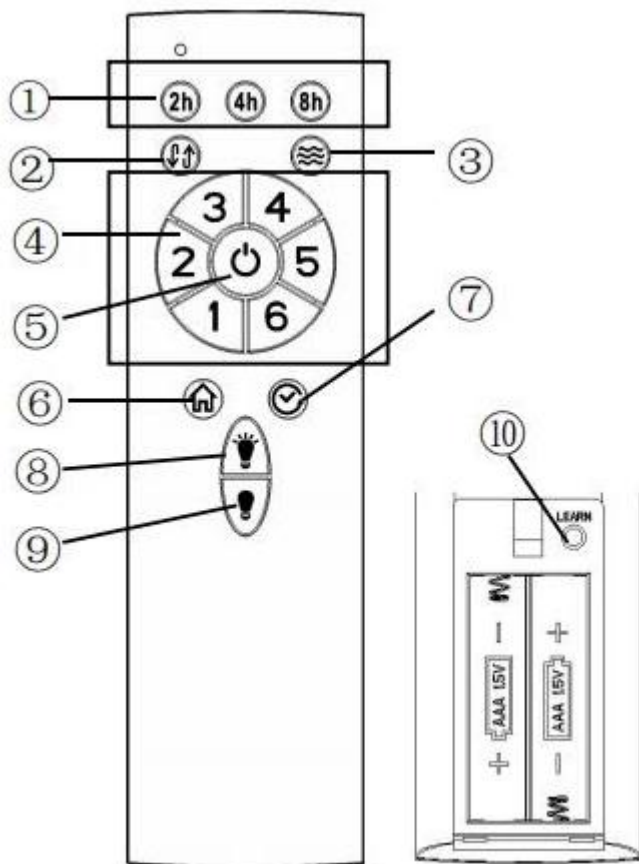

- ① Fonction minuterie : Le ventilateur et la lumière peuvent être réglés sur 2, 4 et 8 heures avant de s'éteindre automatiquement. Lorsque la lumière et le ventilateur sont éteints, ils s'allument automatiquement et vous pouvez activer la fonction minuterie.
- ② Oscillation du ventilateur.
- ③ Ventilation confortable : Le ventilateur fera un cycle aléatoire de la vitesse 2-5
- ④ Vitesse du ventilateur : Contrôlez la vitesse du ventilateur sur une échelle de 1 à 6.
- ⑤ Interrupteur d'alimentation : Allumer/éteindre.
- ⑥ Lumière Bouclier domestique: Au démarrage, le ventilateur s'éteint et la lumière clignote deux fois, puis il circule en mode A-B-A :
A. S'allume 5 à 20 minutes de façon aléatoire.
B. S'éteint après 60 minutes.
- ⑦ Fonction Arrêt différé : le ventilateur et la lumière s'éteignent après une minute.
- ⑧ Lumière: ON
- ⑨ Lumière: OFF
- ⑩ Touche d'apprentissage : Appuyez pour activer l'appairage par code d'apprentissage.

Deux piles AAA 1,5V sont nécessaires.

IMPORTANT

1. Si la télécommande ne fonctionne pas correctement, vérifiez que l'interrupteur de la batterie est normal, que les pôles positifs et négatifs sont correctement placés et que la batterie est suffisante. Si la tension est trop faible, cela affectera l'intensité de la transmission et provoquera une défaillance de la télécommande. Assurez-vous que la pile est remplacée.
2. Si la télécommande ne fonctionne pas correctement, vérifiez s'il existe des produits similaires à proximité. La transmission simultanée d'ondes radio par d'autres produits provoquera des interférences entre eux et affectera les fonctions.
3. La pile perd de sa puissance avec le temps. Remplacez la pile avant qu'elle ne se décharge pour éviter d'endommager la télécommande. Manipulez la pile usagée correctement et gardez-la hors de portée des enfants.
4. Si vous n'utilisez pas l'appareil pendant une longue période, retirez les piles de la télécommande.

Entretien et Nettoyage



AVERTISSEMENT : Assurez-vous que le ventilateur est hors tension avant de le nettoyer.

- En raison du mouvement naturel du ventilateur, certaines connexions peuvent se desserrer. Vérifiez les connexions de support, le support et les fixations des pales deux fois par an. Assurez-vous qu'ils sont bien fixés. Il n'est pas nécessaire de retirer le ventilateur du plafond.
- Nettoyez votre ventilateur de temps en temps. N'utilisez pas d'eau pour le nettoyer, car cela pourrait endommager le moteur, le bois ou provoquer un choc électrique. Utilisez uniquement une brosse douce ou un chiffon non pelucheux pour éviter de rayer la surface. Le placage est scellé avec une laque pour minimiser la décoloration ou le ternissement.
- Vous pouvez appliquer une légère couche de cire pour meubles sur le bois pour une protection supplémentaire. Couvrez les petites éraflures avec une petite quantité de cirage pour chaussures.
- Vous n'avez pas besoin d'huiler votre ventilateur. Le moteur est équipé de roulements à billes étanches lubrifiés en permanence.

Dépannage

Problème	Solution
Le ventilateur ne démarre pas.	<ul style="list-style-type: none"><input type="checkbox"/> Vérifiez les fusibles ou les disjoncteurs des circuits principal et secondaire.<input type="checkbox"/> Vérifiez les connexions des câbles de ligne au ventilateur et les connexions des câbles de l'interrupteur dans le boîtier.
Le ventilateur est bruyant.	<ul style="list-style-type: none"><input type="checkbox"/> Vérifiez que toutes les vis du boîtier du moteur sont bien serrées.<input type="checkbox"/> Assurez-vous que les vis qui fixent le support de pale au moyeu du moteur sont bien serrées.<input type="checkbox"/> Assurez-vous que les connexions des câbles et des écrous ne s'entrechoquent pas et qu'elles ne s'entrechoquent pas avec la paroi intérieure du boîtier de l'interrupteur.<input type="checkbox"/> Prévoyez une période de rodage de 24 heures. La plupart des bruits associés à un nouveau ventilateur disparaissent pendant cette période.<input type="checkbox"/> Si vous utilisez le kit d'éclairage pour ventilateur de plafond, assurez-vous que les vis de la verrerie sont bien serrées. Vérifiez que les ampoules sont bien fixées.<input type="checkbox"/> Assurez-vous que le capot est à une courte distance du plafond. Il ne doit pas toucher le plafond.<input type="checkbox"/> Assurez-vous que votre boîte de sortie est bien fixée et que des coussinets isolants en caoutchouc ont été utilisés entre la plaque de montage et la boîte de sortie.
Le ventilateur oscille.	<ul style="list-style-type: none"><input type="checkbox"/> Vérifiez que les vis des pales et des bras sont bien fixées.<input type="checkbox"/> La plupart des problèmes sont causés par des niveaux inégaux des pales. Vérifiez le niveau en choisissant un point au plafond au-dessus de l'extrémité d'une des pales. Mesurez à partir d'un point situé au centre de la pale jusqu'au plafond. Faites tourner le ventilateur jusqu'à ce que la pale suivante soit positionnée pour la mesure, puis mesurez à partir du même point sur chaque pale jusqu'au plafond. Les différences éventuelles ne doivent pas dépasser 1/8 pouce. Faites tourner le ventilateur pendant dix minutes. Si le ventilateur continue à osciller, contactez le service clientèle et un kit d'équilibrage vous sera envoyé gratuitement.

FR: Ce produit contient une source lumineuse de classe d'efficacité énergétique <F>.

- 1-Classe di protezione I: L'apparecchio è dotato di un collegamento con messa a terra: il cavo di terra (giallo/verde) deve essere collegato alla clip contrassegnata dal simbolo .
- 2- Collocare il prodotto solo in ambienti asciutti e tenerlo lontano da sostanze umide.
- 3- Il consumo per il funzionamento del motore è in Watt.
- 4- Può essere azionato con un telecomando.

AVVERTENZE

- Leggere attentamente questo manuale prima dell'installazione e conservarlo per riferimenti futuri.
 - Per ridurre il rischio di lesioni personali, collegare il ventilatore direttamente alla struttura portante dell'edificio secondo le seguenti istruzioni. Utilizzare solo i componenti forniti.
 - Per evitare di prendere scosse elettriche, prima di installare il ventilatore, scollegare dalla corrente disattivando gli interruttori automatici delle prese e degli interruttori a parete.
 - Tutti i cavi devono essere conformi alle normative elettriche nazionali e locali. Se non si ha familiarità con l'operazione di cablaggio, contattare un elettricista professionista.
 - Per ridurre il rischio di lesioni personali, non piegare le pale del ventilatore pala durante l'installazione o la pulizia. Non inserire mai oggetti tra le pale rotanti del ventilatore.
 - Per ridurre il rischio di incendi, scosse elettriche o danni al motore, non sollevare o trasportare la ventola per i cavi.
 - Quando si monta il ventilatore, assicurarsi che il soffitto possa sostenere un peso di almeno 15,8 kg (35 libbre).
- Le pale del ventilatore non possono essere installate ad una distanza inferiore a 2,3 m dal pavimento.

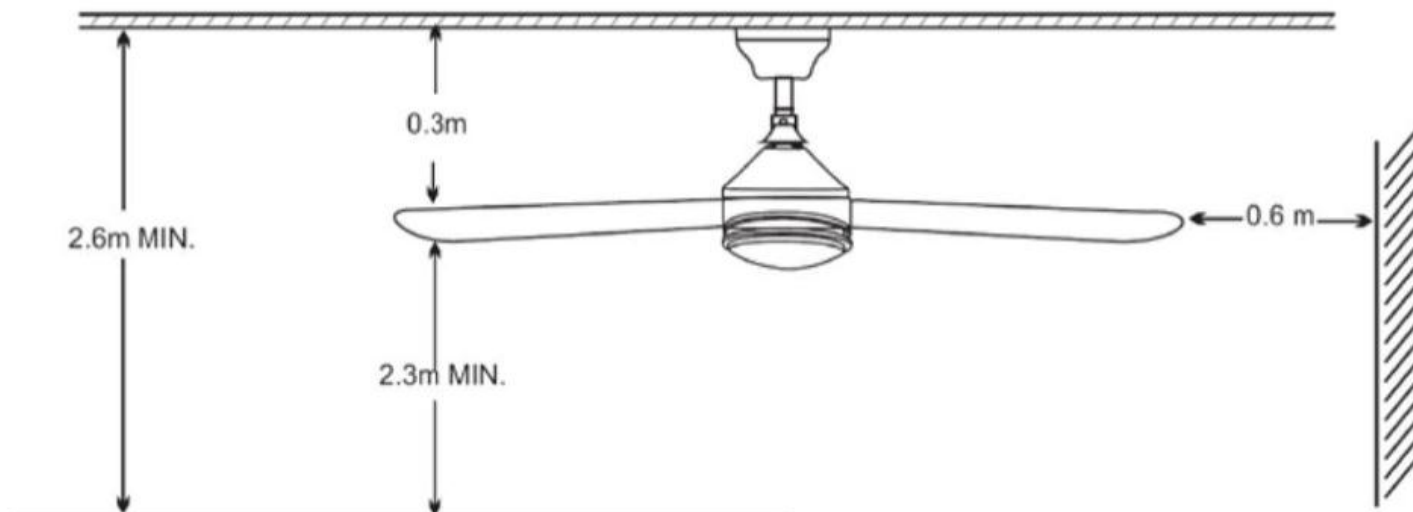

AVVISO:

Le importanti precauzioni, misure di sicurezza e istruzioni indicate in questo manuale non coprono tutte le possibili condizioni e situazioni che possono verificarsi. Si deve comprendere che l'uso del buon senso, la cautela e la prudenza sono fattori che devono essere sempre presi in considerazione. Questi fattori devono essere presi in considerazione dalle persone che installano, mantengono e utilizzano il prodotto.

IMPORTANTI PRECAUZIONI DI SICUREZZA

Leggere le istruzioni e verificare che tutte le parti siano presenti prima di iniziare il montaggio.

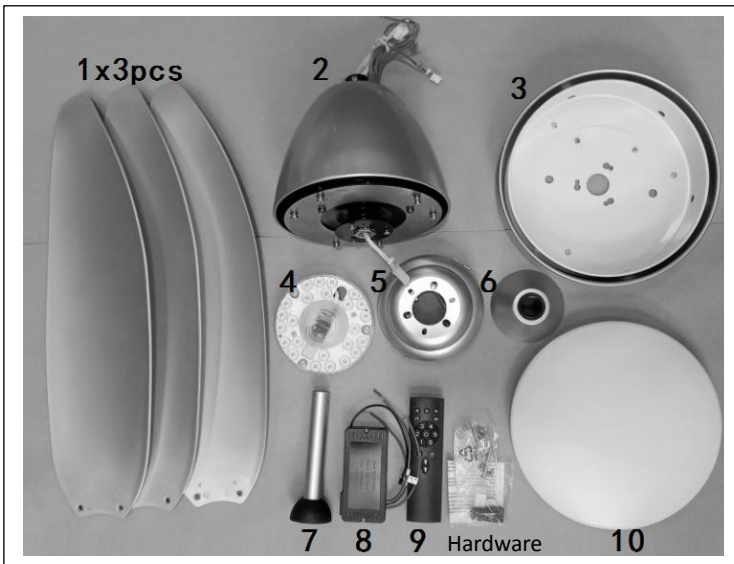
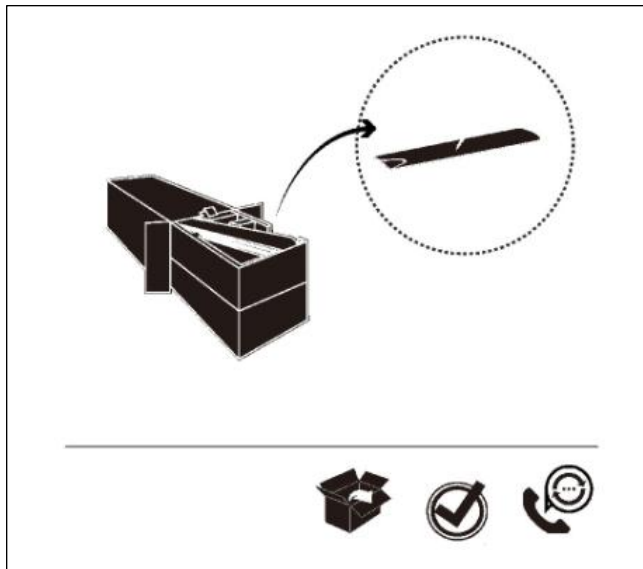

Hardware List

Ax2pcs



Φ6X40

Bx2pcs



ST4. 8*38

Cx7pcs



1/4-20*17

Dx2pcs



SM4*20

AVVISO:

Per ridurre il rischio di lesioni personali, utilizzare il kit di installazione fornito.

STRUMENTI NECESSARI

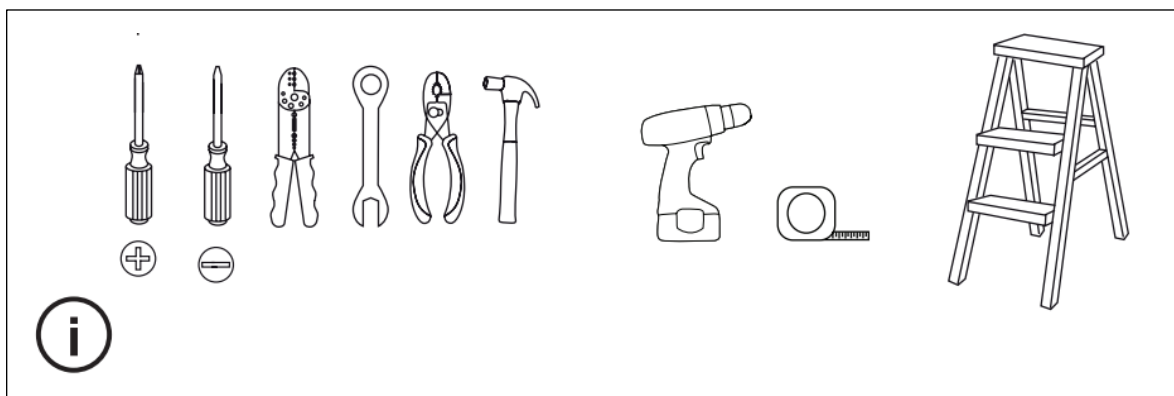

Spegnere l'alimentazione prima dell'installazione.

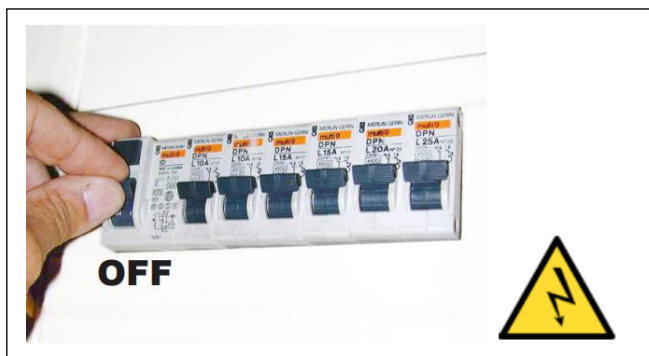

PREPARAZIONE PER IL MONTAGGIO

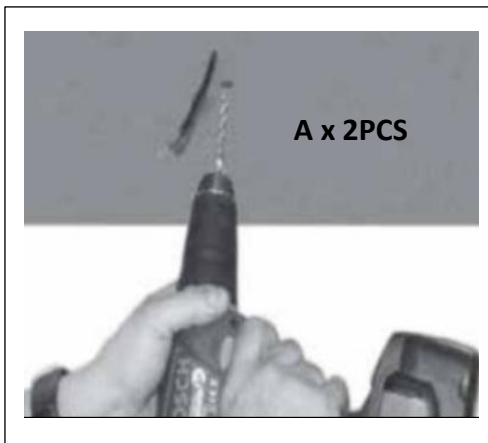

1. Rimuovere l'imballaggio dal montante e installare il montante al soffitto. Assicurarsi che il soffitto possa supportare il peso in caso di minimo in movimento della ventola, che è di 15,8 kg o 35 libbre.

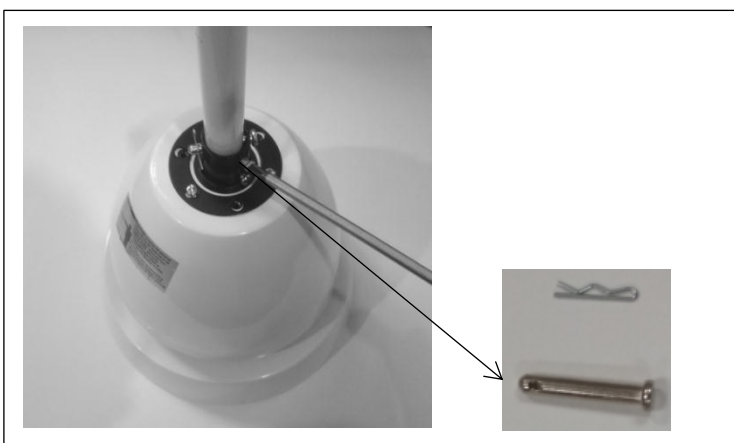
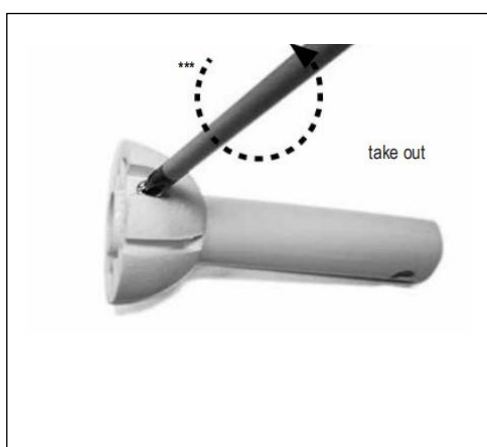

2. Rimuovere la sfera di nylon il montante inferiore ed estrarre il perno e il bullone dal motore. Far passare i cavi attraverso il montante inferiore e reinserire il perno e il bullone. Stringere la vite che tiene in posizione il montante inferiore.

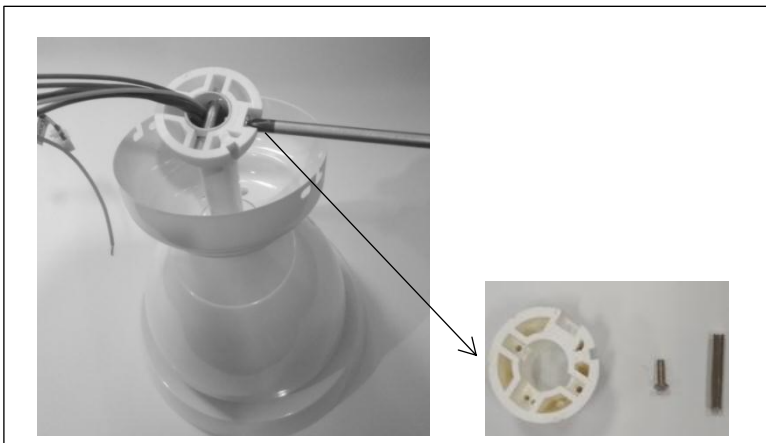

3. Posizionare l'involucro del motore e dei cavi attraverso il montante inferiore. Reinscrivere la sfera di nylon, il perno e la vite nel montante inferiore.

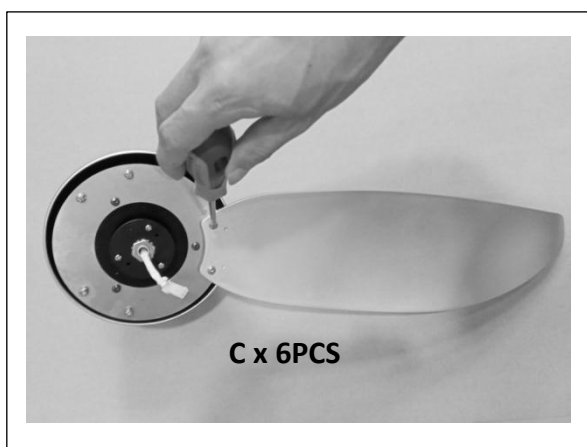

4. Installare le pale della ventola. Assicurarsi che le viti siano strette.

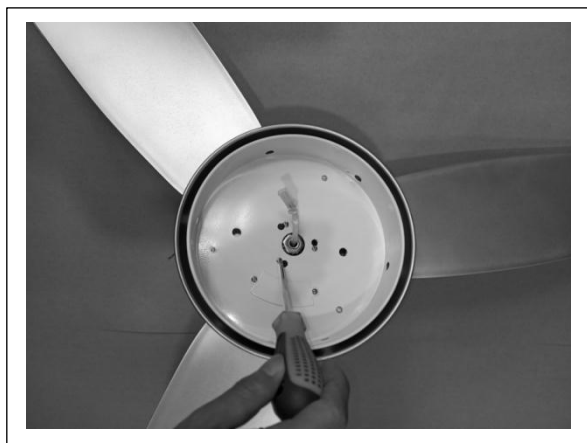

5. Installare il kit delle luci sul motore stringendo le viti.

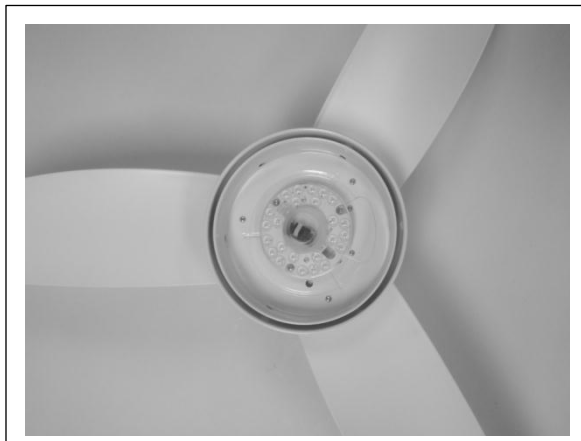

6. Collegare le due spine. Collegare il pannello LED al motore. Posizionare il LED al centro del pannello.

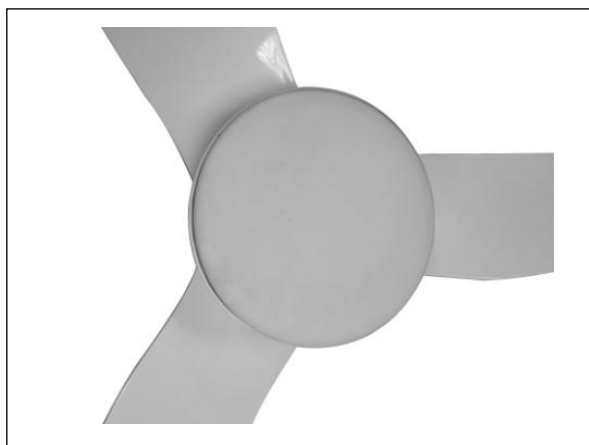

7. Ruotare la lampada di vetro in senso orario finché non si blocca in posizione.

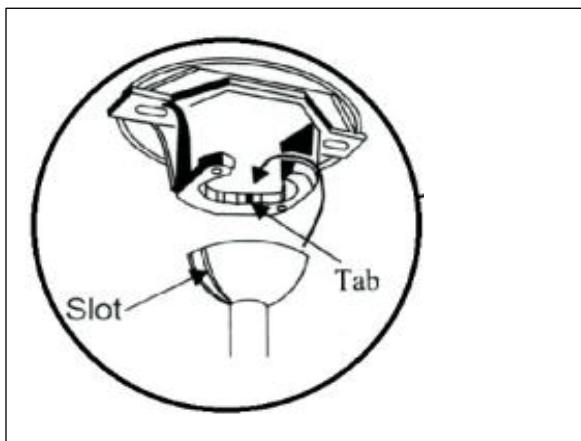
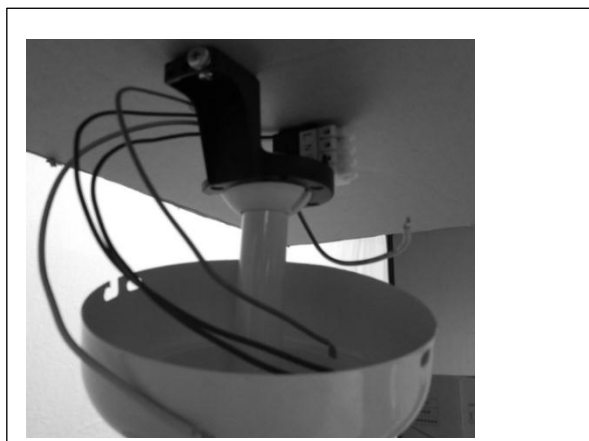

8. Sollevare il ventilatore e posizionare la sfera di nylon sul montante. Assicurarsi che il perno guida del montante si inserisca nella sfera.

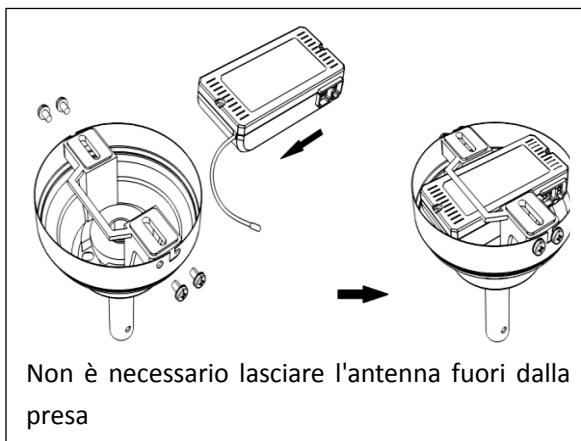
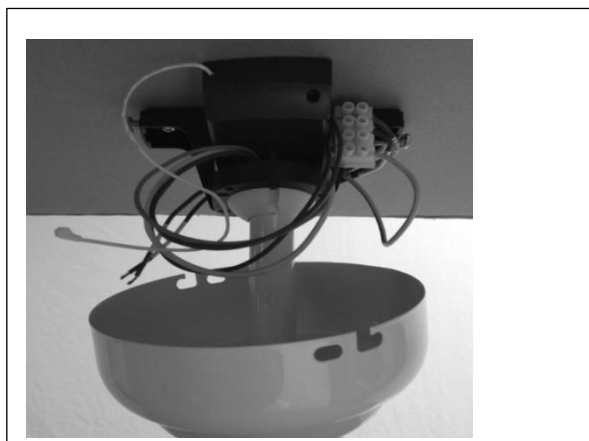

9. Collocare il ricevitore remoto al centro del montante e collegare i cavi secondo le istruzioni.

Alimentazione dal soffitto (230V/50Hz)

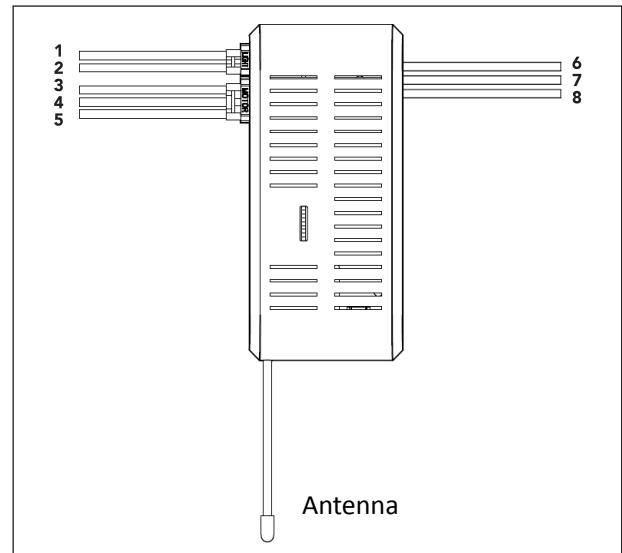
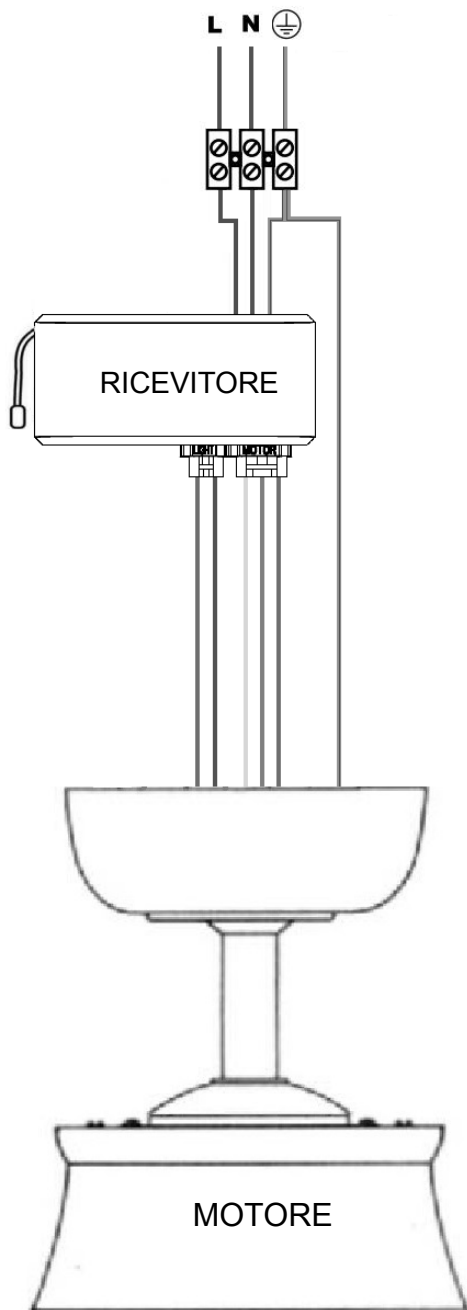

Parti:

- 1: Cavo sottile L (Rosso)
- 2: Cavo sottile N (Blu)
- 3: Cavo fase motore U (Grigio)
- 4: Cavo fase motore V (Giallo)
- 5: Cavo fase motore W (Rosso)
- 6: AC IN L (Marrone)
- 7: AC IN N (Blu)
- 8: Cavo di messa a terra (Verde & Giallo)

10. Schema di collegamento del telecomando.



11. Montare nuovamente il montante al soffitto. Utilizzare le viti di fissaggio per stringere al soffitto, assicurarsi che sia ben saldo e che non vi siano cavi intrappolati.

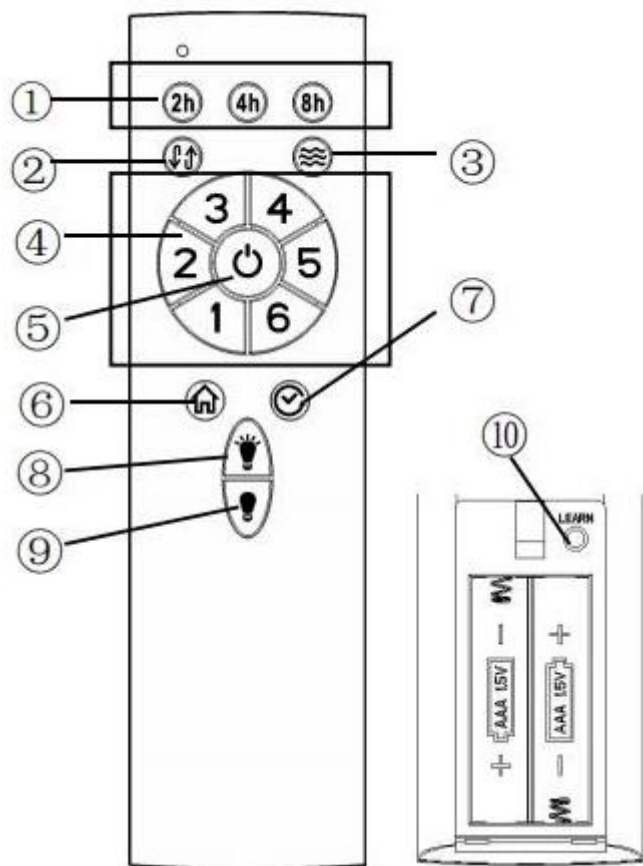

- ① Funzione timer: ventilatore e luci possono essere impostati 2, 4 e 8 ore prima dello spegnimento automatico. Quando ventilatore e luci sono spenti, si accendono automaticamente e sarà possibile attivare la funzione timer.
- ② Oscillazione del ventilatore.
- ③ Brezza confortevole: il ventilatore funzionerà a velocità casuale da 2-5
- ④ Velocità delle pale: Controlla la velocità del ventilatore da 1-6.
- ⑤ Interruttore alimentazione: Spegne/accende.
- ⑥ Luminosità domestica: all'avvio, il ventilatore è spento e la luce lampeggia due volte, quindi si metterà in moto in modalità A-B-A:
A. 5-20 minuti a velocità casuale.
B. Si spegne dopo 60 minuti.
- ⑦ Funzione ritardo: Il ventilatore e la luce si accendono dopo un minuto.
- ⑧ Luce: ON
- ⑨ Luce: OFF
- ⑩ Pulsante di apprendimento: toccare per attivare l'associazione del codice di apprendimento.

Necessarie due batterie AAA 1.5V.

! IMPORTANTE

1. Se il telecomando non funziona correttamente, controllare se la batteria presenta anomalie, se i poli positivo e negativo sono posizionati correttamente e se il livello di carica è sufficiente. Se la tensione è troppo bassa, influenzerà l'intensità di trasmissione e causerà un guasto del telecomando. In tal caso, assicurarsi che la batteria sia sostituita.
2. Se il telecomando non funziona correttamente, controllare se ci sono prodotti simili nelle vicinanze. La trasmissione simultanea di onde radio da parte di altri prodotti causerà interferenze reciproche e ne influenzerà le funzioni.
3. La batteria diminuirà di potenza nel tempo. Sostituire la batteria prima che perda troppa potenza per evitare di danneggiare il telecomando. Maneggiare correttamente la batteria usata e tenerla fuori dalla portata dei bambini.
4. Se non utilizzato a lungo, rimuovere le batterie dal telecomando.

Cura e Pulizia



AVVERTENZA: assicurarsi che di spegnere l'alimentazione elettrica prima di pulire il ventilatore.

“ A causa del movimento naturale del ventilatore, alcuni raccordi potrebbero allentarsi. Controllare le connessioni di supporto, del montante e gli attacchi delle pale due volte l'anno. Assicurati che siano sicuri. Non è necessario rimuovere il ventilatore dal soffitto.

“ Pulire il ventilatore di tanto in tanto. Non utilizzare acqua durante la pulizia, poiché ciò potrebbe danneggiare il motore, il legno o causare scosse elettriche. Utilizzare solo una spazzola morbida o un panno senza peli per evitare di graffiare la superficie. La placcatura è sigillata con una lacca per ridurre al minimo lo scolorimento o l'appannamento.

“ È possibile applicare un leggero strato di lucido per mobili sul legno per ottenere una protezione aggiuntiva. Coprire i piccoli graffi passando una piccola quantità di lucido per scarpe.

“ Non è necessario lubrificare il ventilatore. Il motore è dotato di cuscinetti a sfera sigillati a lubrificazione permanente.

Risoluzione dei problemi

Problema	Soluzione
Il ventilatore non si accende	<input type="checkbox"/> Controllare i fusibili o gli interruttori sia del circuito principale che di quello derivato. <input type="checkbox"/> Controllare i collegamenti dei cavi di rete al ventilatore e i collegamenti dei cavi dell'interruttore presenti nell'alloggiamento.
Il ventilatore è rumoroso.	<input type="checkbox"/> Assicurarsi che tutte le viti dell'alloggiamento del motore siano strette. <input type="checkbox"/> Assicurarsi che le viti che fissano le pale al montante del motore siano strette. <input type="checkbox"/> Assicurarsi che i raccordi dei dadi non sbattano l'uno contro l'altro o contro la parete interna dell'alloggiamento dell'interruttore. <input type="checkbox"/> mettere in funzione per un periodo di "rodaggio" di 24 ore. La maggior parte dei rumori associati a un nuovo ventilatore scompare in questo periodo. <input type="checkbox"/> Se si utilizza il kit luci del ventilatore da soffitto, assicurarsi che le viti nella lampada di vetro siano ben strette. Controllare che le lampadine siano sicure. <input type="checkbox"/> Assicurarsi che la parte superiore del ventilatore sia poco distante dal soffitto. Non dovrebbe toccare il soffitto. <input type="checkbox"/> Assicurarsi che il circuito di derivazione sia sicuro e che i cuscinetti isolanti in gomma siano utilizzati tra la piastra di montaggio e il circuito di derivazione.
Il ventilatore traballa.	<input type="checkbox"/> Controllare che le viti delle pale e del braccio rotante siano ben strette. <input type="checkbox"/> La maggior parte dei problemi si verifica quando i livelli delle pale non sono uguali. Controllare il livello selezionando un punto sul soffitto sopra la punta di una delle pale. Misurare da un punto al centro della pala fino al soffitto. Ruotare il ventilatore fino a posizionare la pala successiva per effettuare nuovamente la misurazione, quindi misurare dallo stesso punto su ciascuna pala fino al soffitto. Eventuali differenze dovrebbero essere entro 1/8 di pollice. Mettere in funzione il ventilatore per dieci minuti. Se continua a traballare, contattare il servizio clienti e vi verrà inviato gratuitamente un kit di bilanciamento.

IT: Il nostro prodotto contiene una lampadina LED di classe di efficienza energetica <F>.