

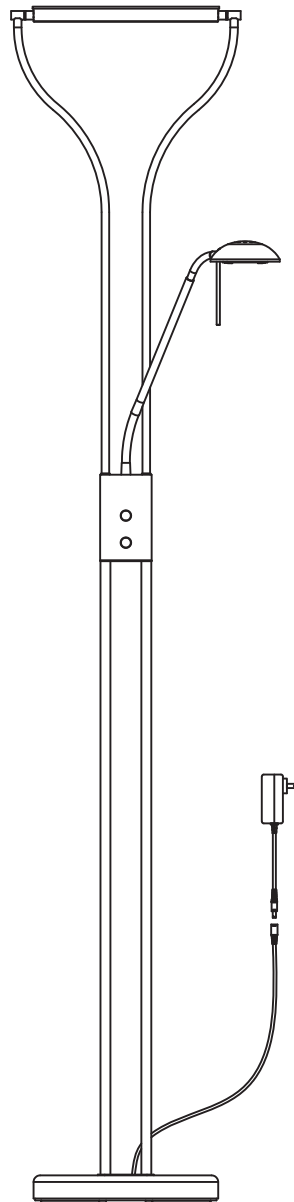











INcnb122_US_CA

B31-287



IMPORTANT, RETAIN FOR FUTURE REFERENCE: READ CAREFULLY

ASSEMBLY & INSTRUCTION MANUAL

A		1
B		2
C		1
D		1
E		1
F		2
G		2
H		1
I		1
J		1

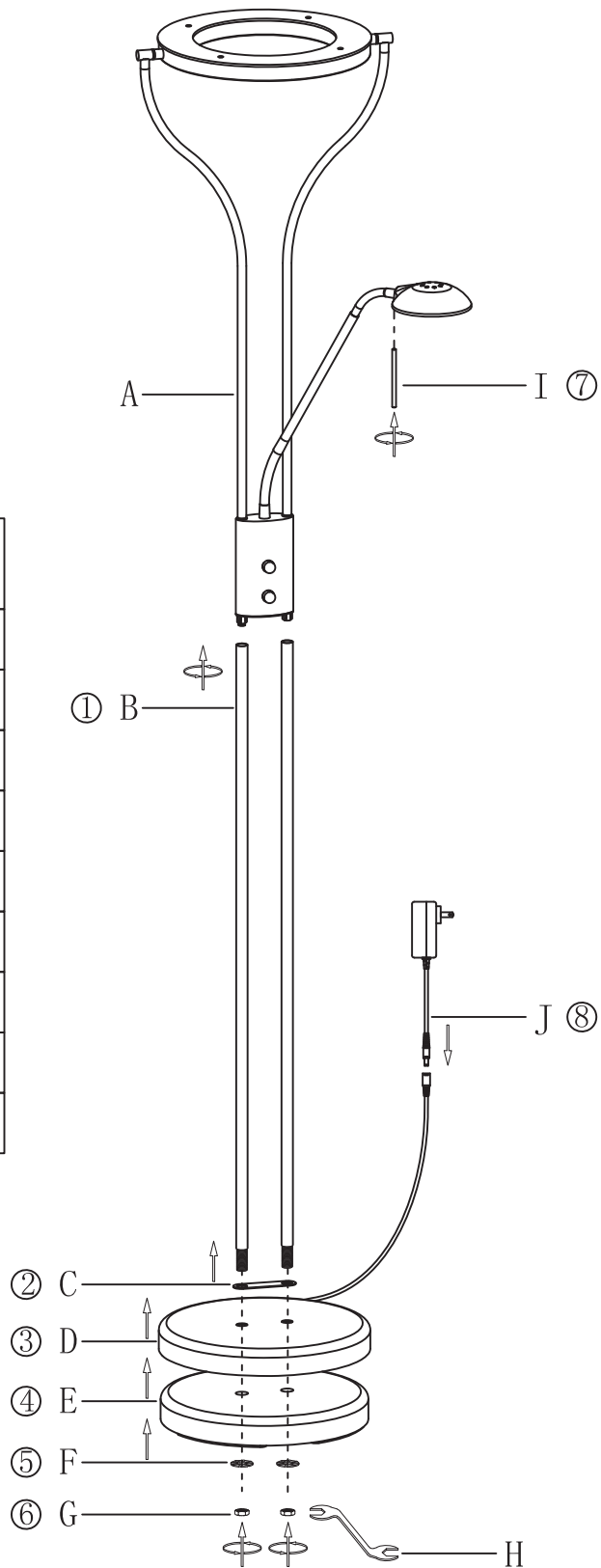

Input voltage	100-120	V
Input AC frequency	60	Hz
Output voltage	24	V
Output current	1	A
Output power	24	W
Average active efficiency	86.2	%
Efficiency at low load (10 %)	82	%
No-load power consumption	0.1	W