

**EN\_** IMPORTANT, RETAIN FOR FUTURE REFERENCE: READ CAREFULLY.

**FR\_** IMPORTANT: A LIRE ATTENTIVEMENT ET À CONSERVER POUR CONSULTATION ULTÉRIEURE.

**ES\_** IMPORTANTE, LEA Y GUARDE PARA FUTURAS REFERENCIAS.

**DE\_**, WICHTIG! SORGFÄLTIG LESEN UND FÜR SPÄTER NACHSCHLAGEN AUFBEWAHREN."

**IT\_** IMPORTANTE! CONSERVARE IL PRESENTE MANUALE PER FUTURO RIFERIMENTO E LEGGERLO ATTENTAMENTE.

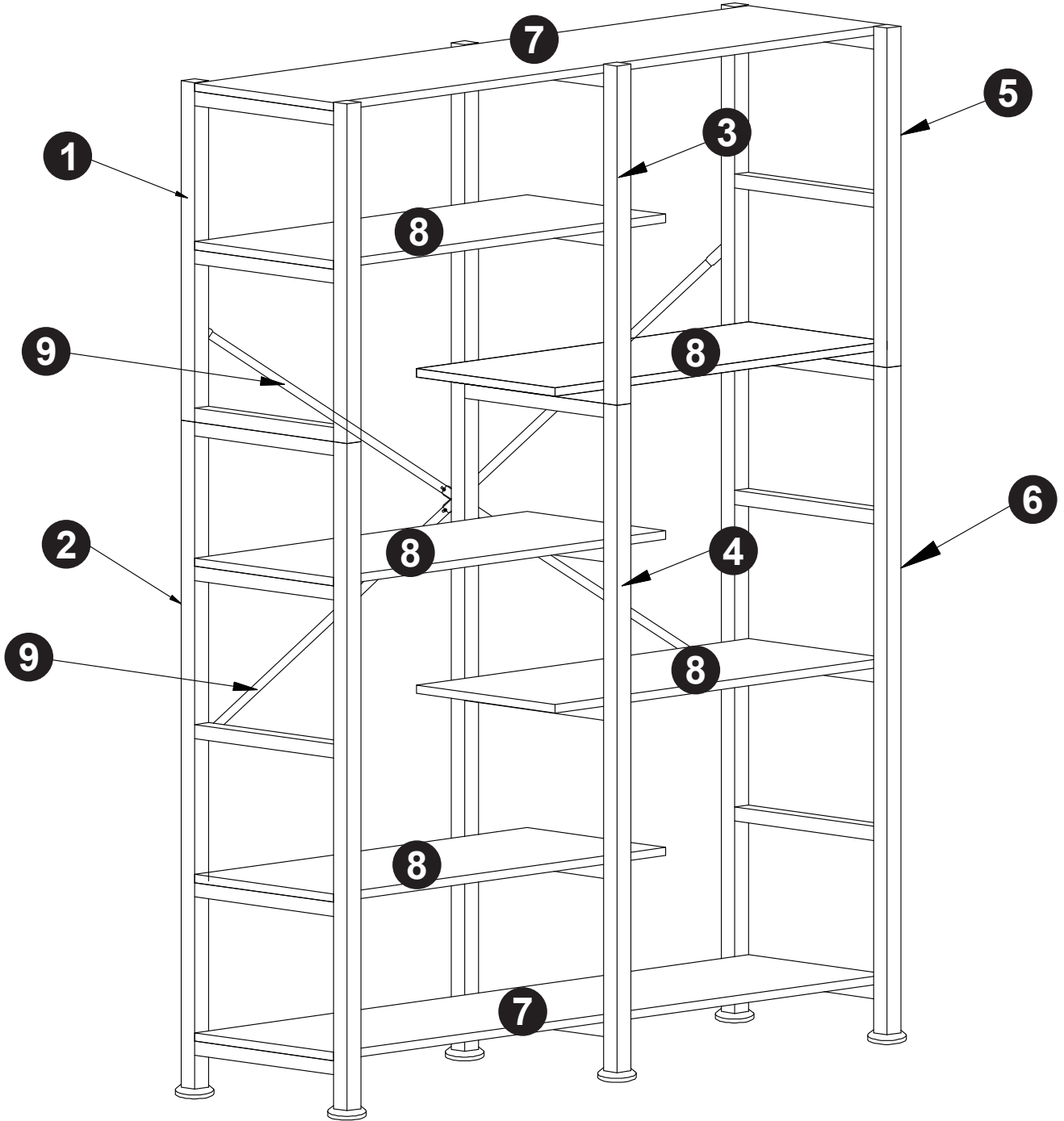

**A** X 33  
+1 (spare)

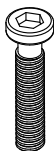

M6\*35

**B** X 4  
+1 (spare)

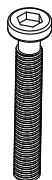

M6\*60

**C** X 7  
+1 (spare)



**D** X 6



8X40X20

**E** X 2



M6\*55

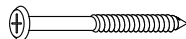

**F** X 1



6X8mm



1PCS

**G** X 1

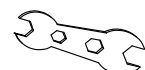
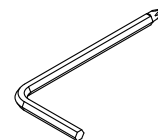

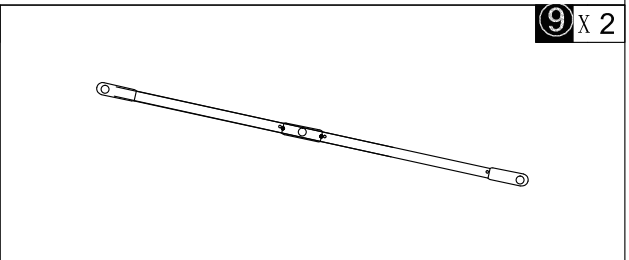
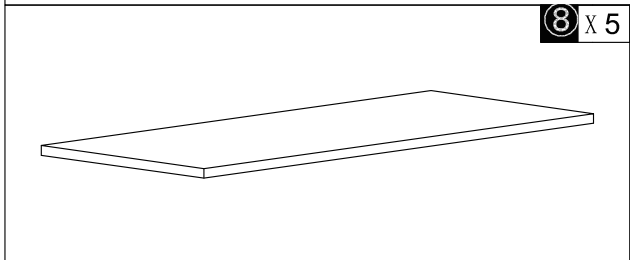
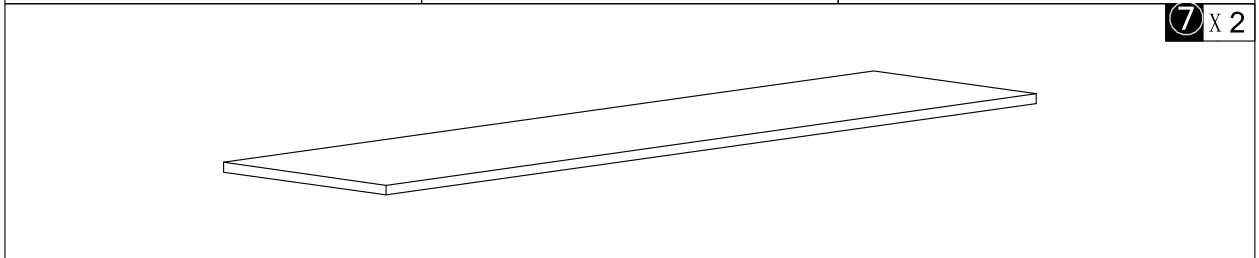
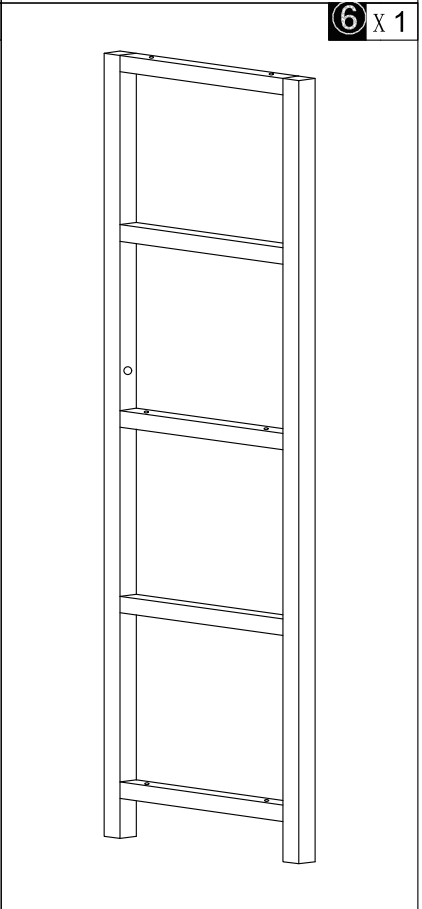
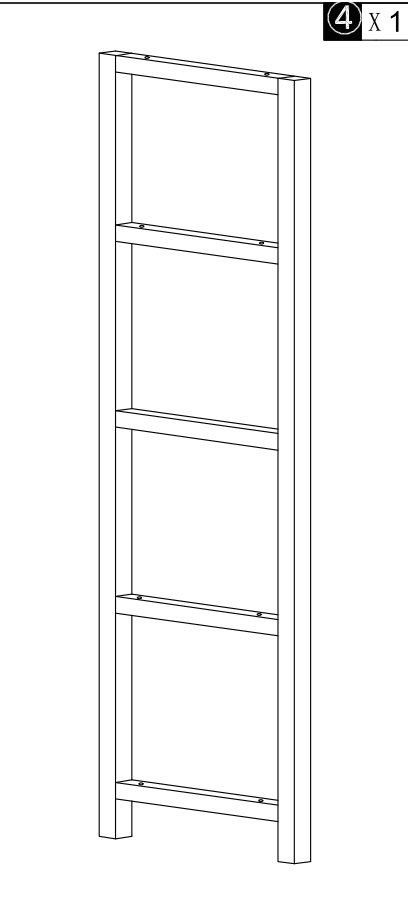
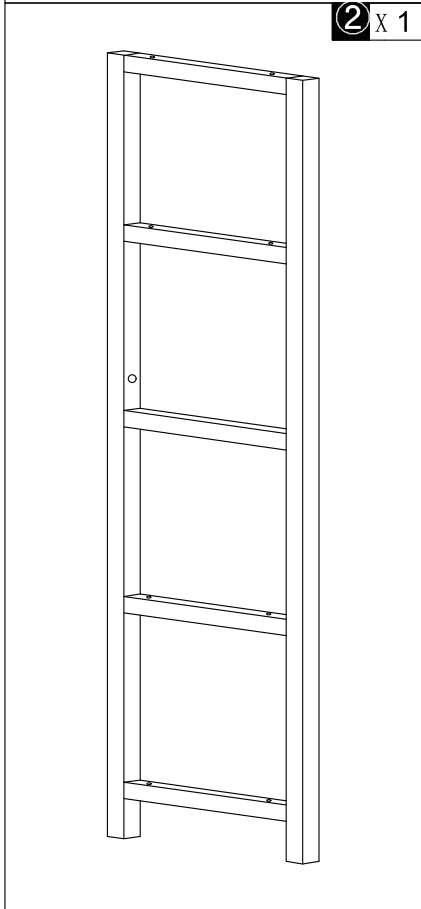
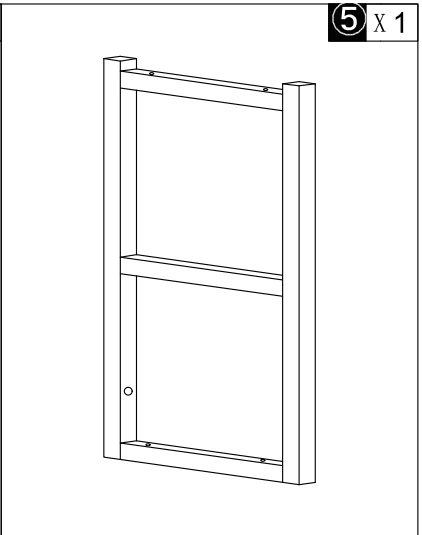
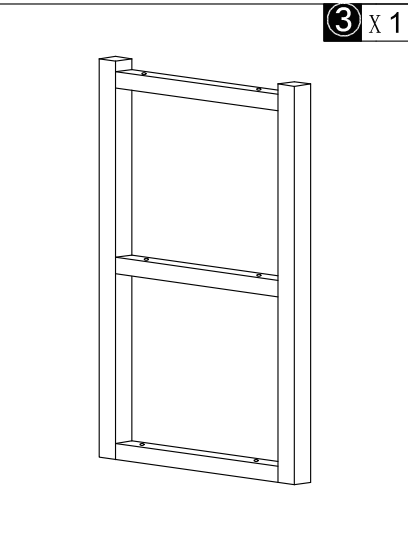
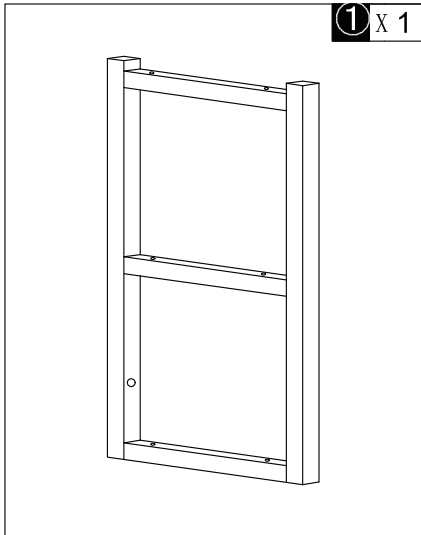

**D** x 6

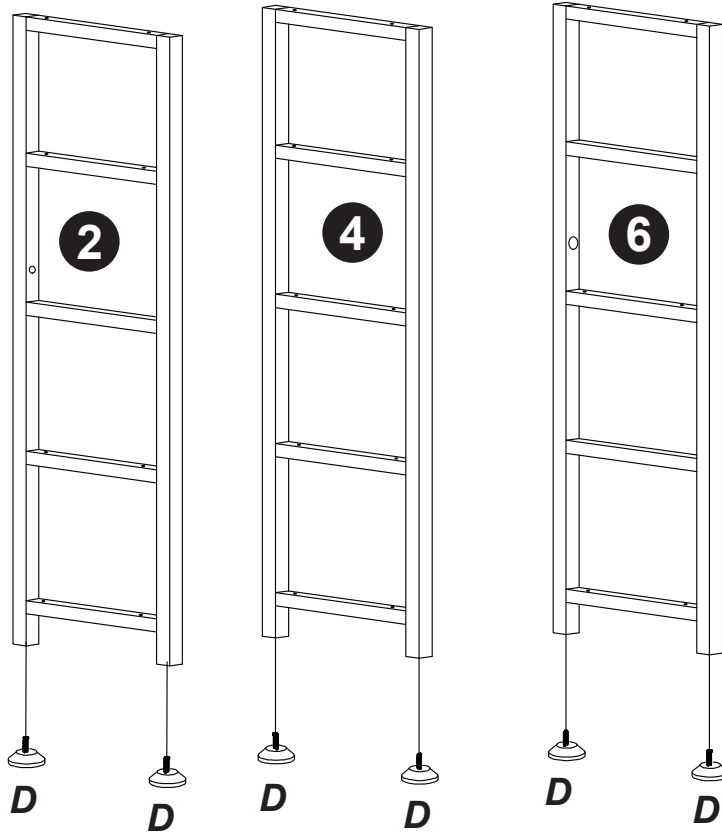

**B** x 4



M6\*60

**C** x 2



**E** x 2

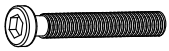

M6\*55

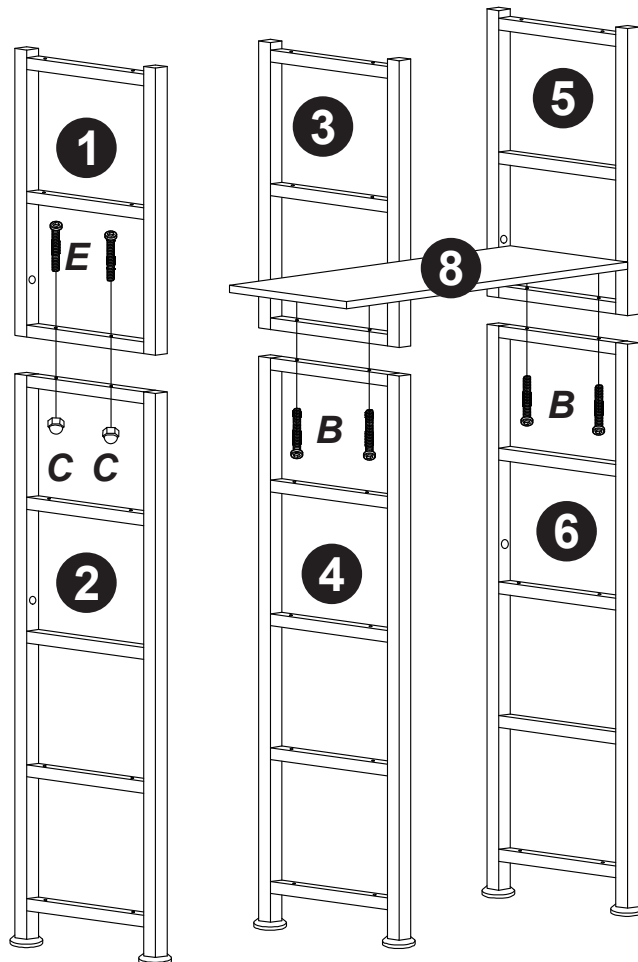

**A** x12

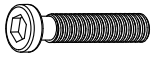

M6\*35

**03**

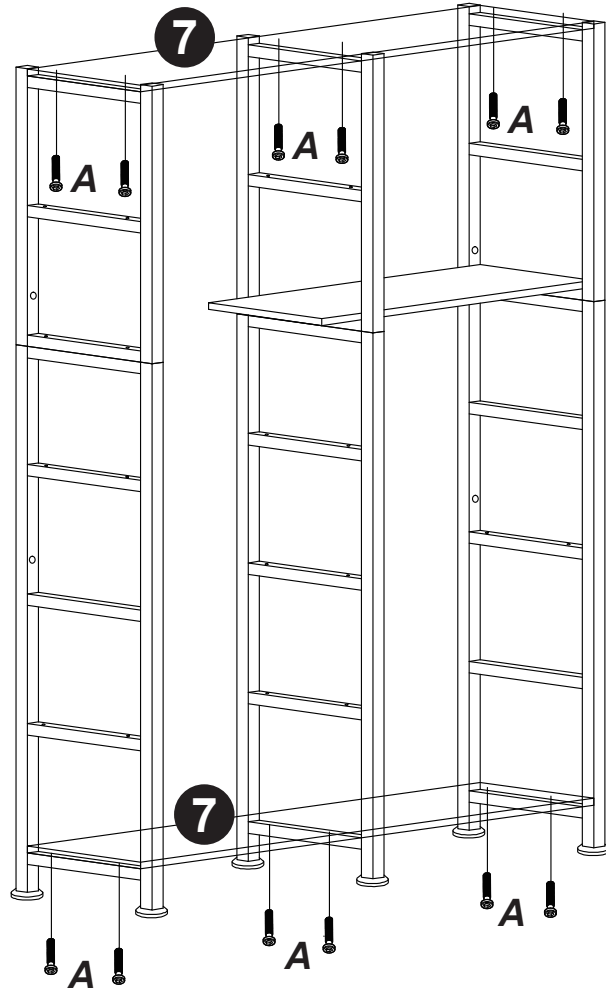

**A** x16

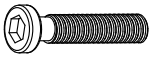

M6\*35

**04**

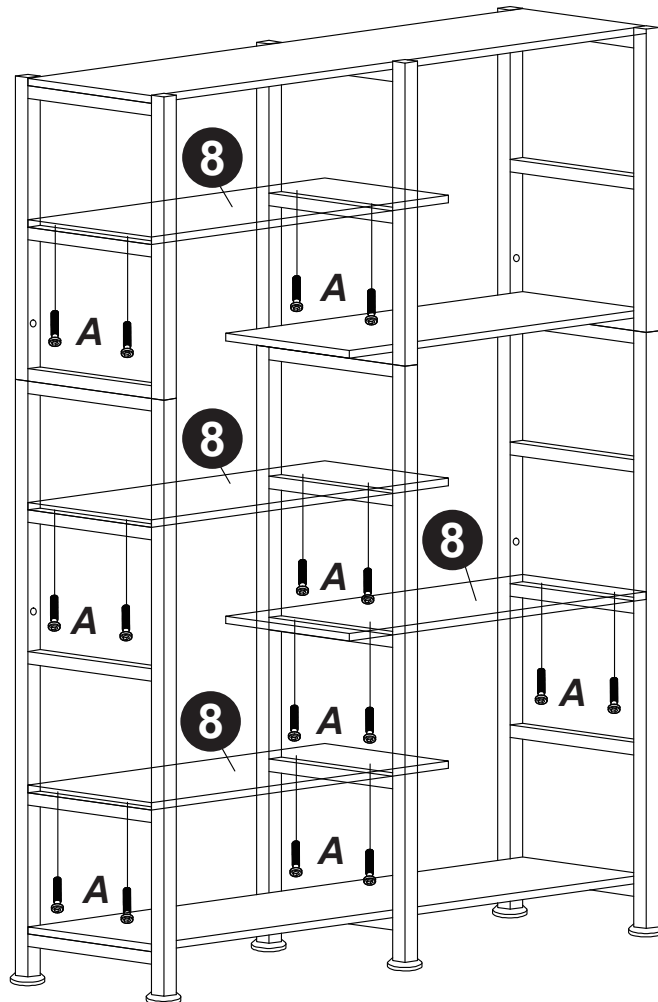

**A** X 5

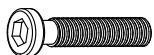

M6\*35

**C** X 5



**F** X 1

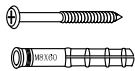

6x8mm

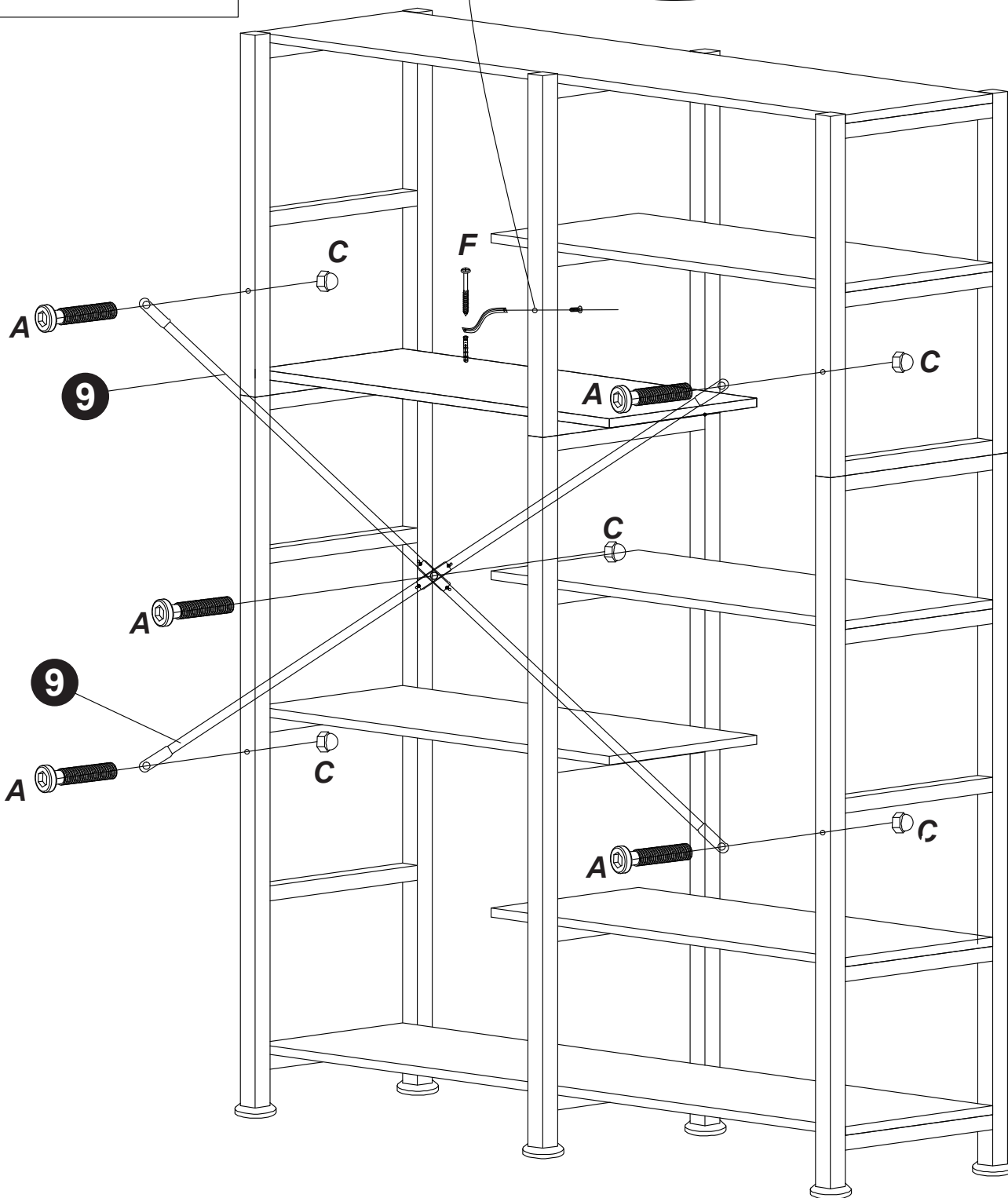
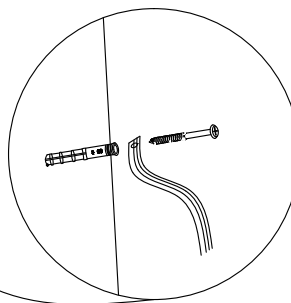

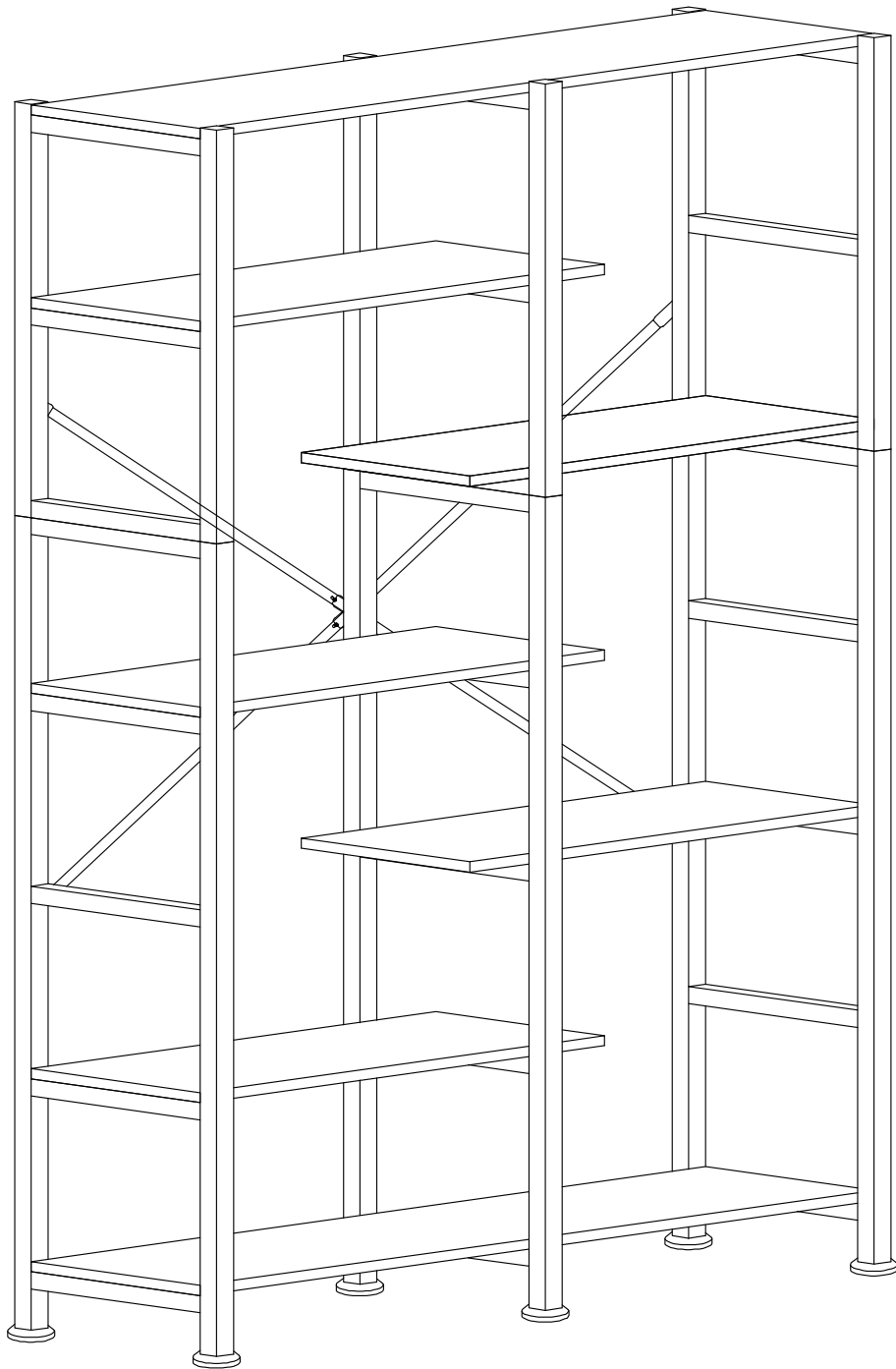



FR

**Pensez à  
donner ou recycler.**



Association

ou



Magasin

ou



Déchèterie

<https://quefairedemesdechets.fr>