



INcqb094_GL

920-050



IMPORTANT, RETAIN FOR FUTURE REFERENCE: READ CAREFULLY

Tools Recommended

ASSEMBLY & INSTRUCTION MANUAL

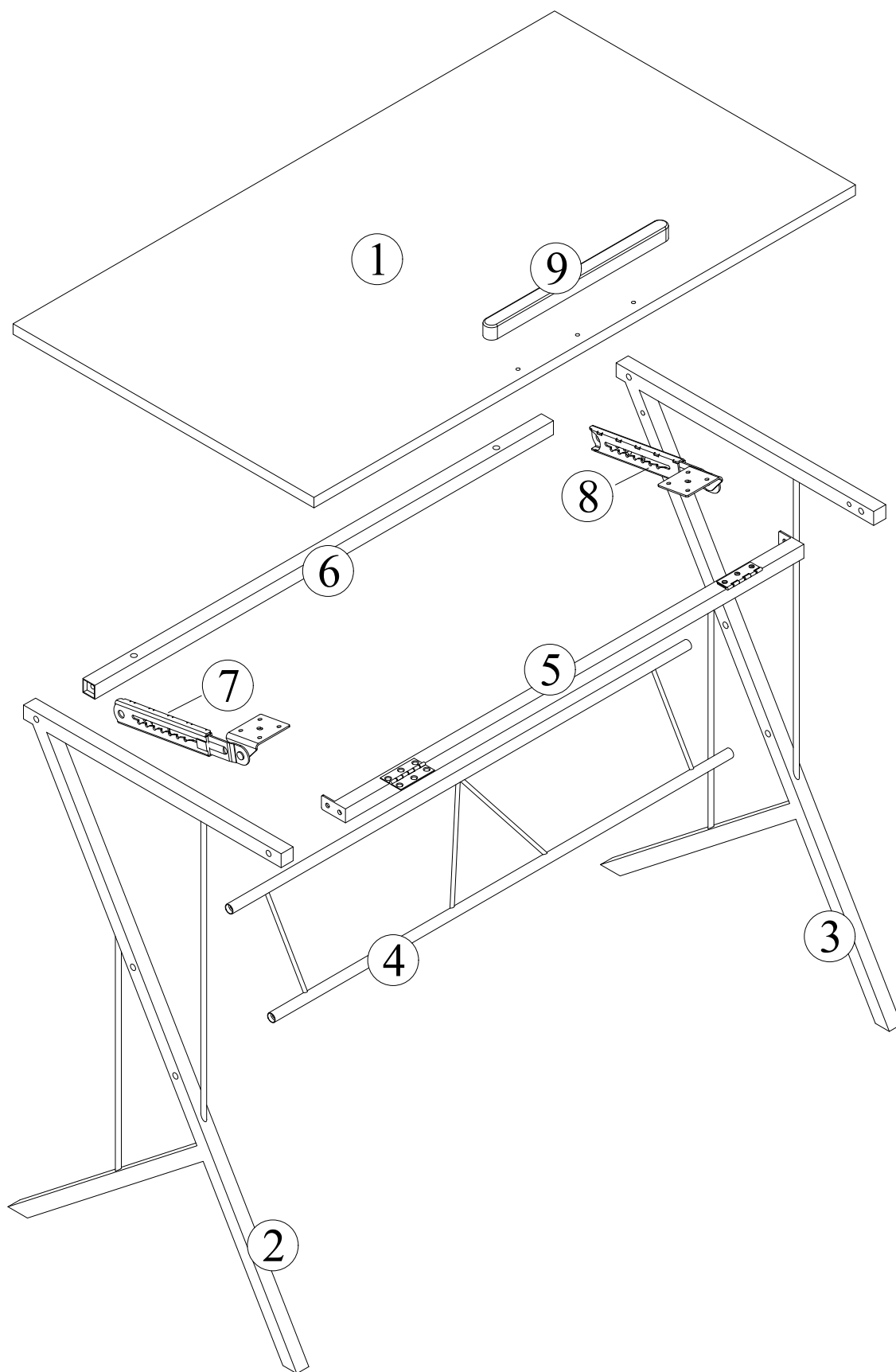

A x 2
M6*15

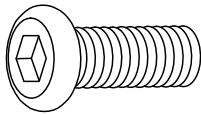

B x 2
M6*30

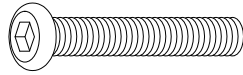

C x 8
M6*40

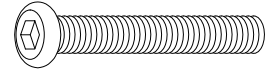

D x 14
M4*14

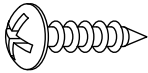

E x 3
M4*25

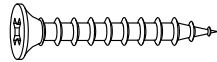

F x 6

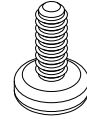

G x 4

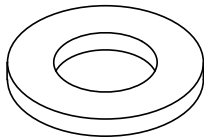

H x 1

