

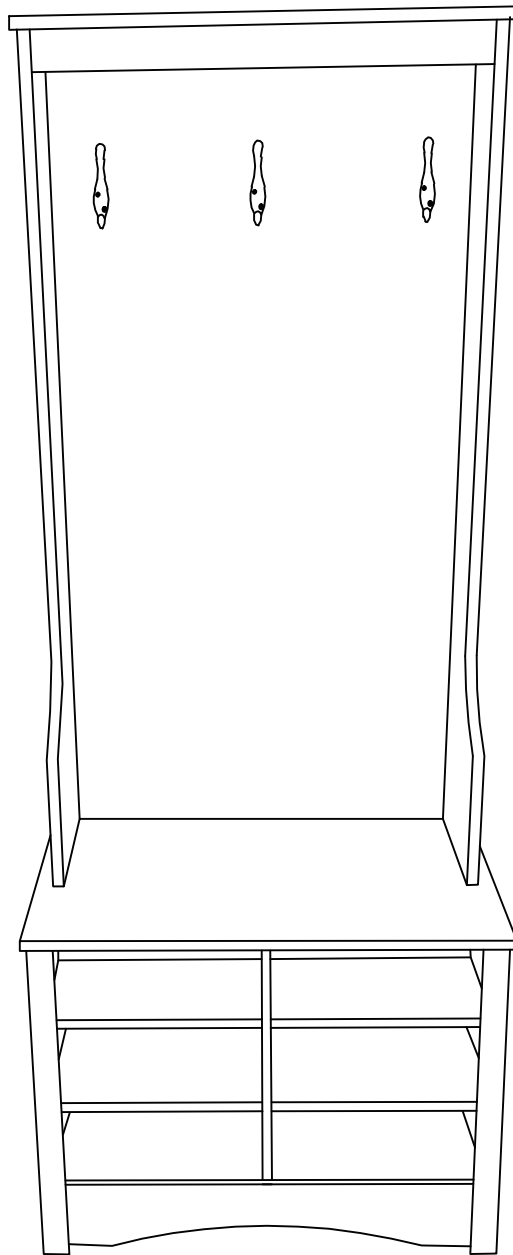

INctc004V01\_GL

**837-100**



READ AND SAVE THESE INSTRUCTIONS FOR FUTURE USE

**ASSEMBLY INSTRUCTION**

A x 1

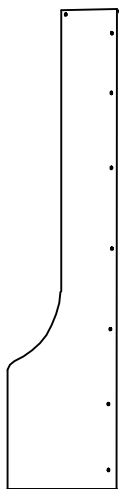

B x 1

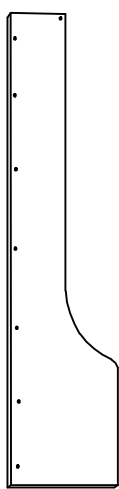

C x 1

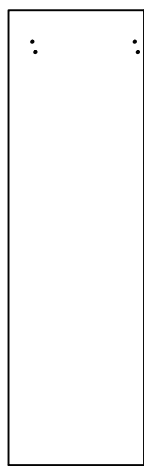

D x 1

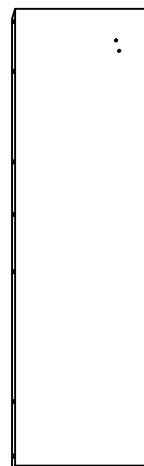

E x 1

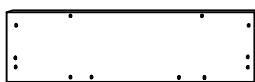

F x 1

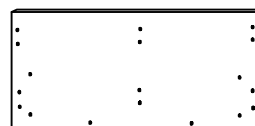

G x 2

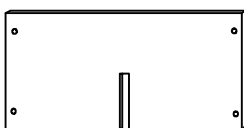

H x 1

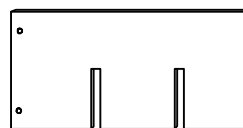

I x 1

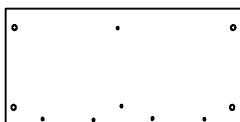

J x 1

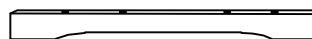

K x 1

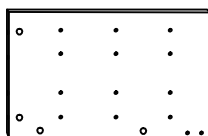

L x 1

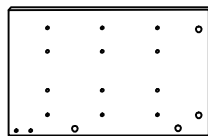

M x 1

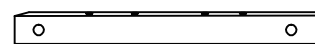

N x 2



O x 1

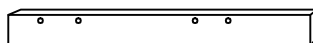

P x 1

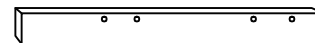

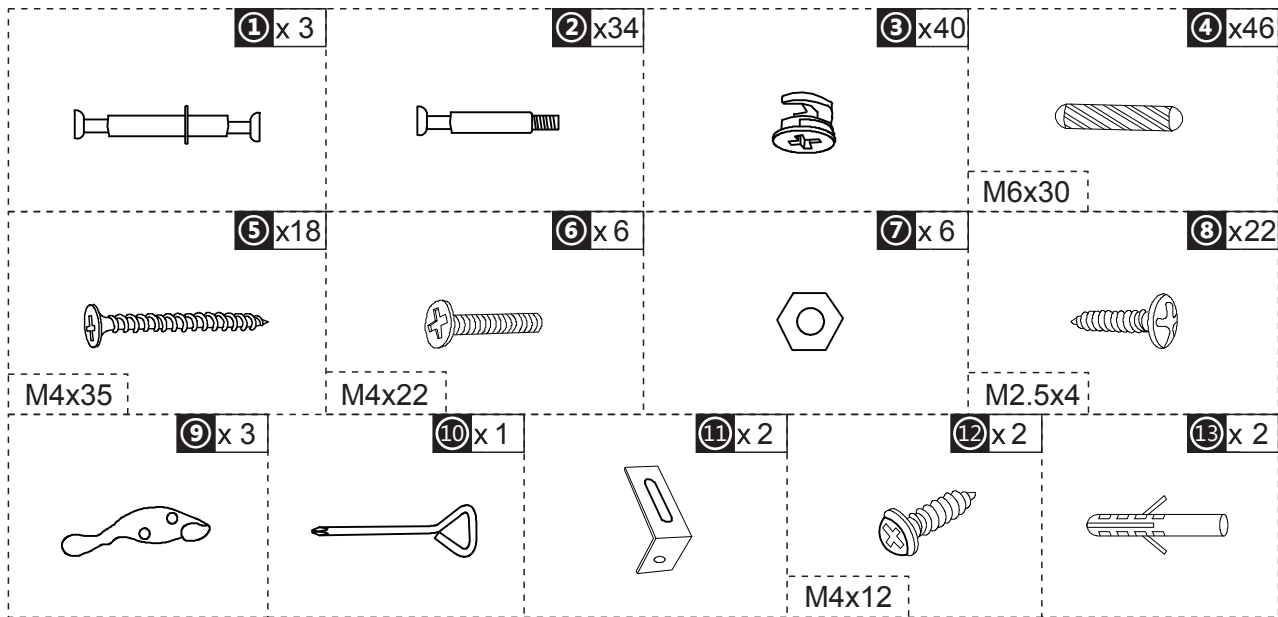

**PART LIST**

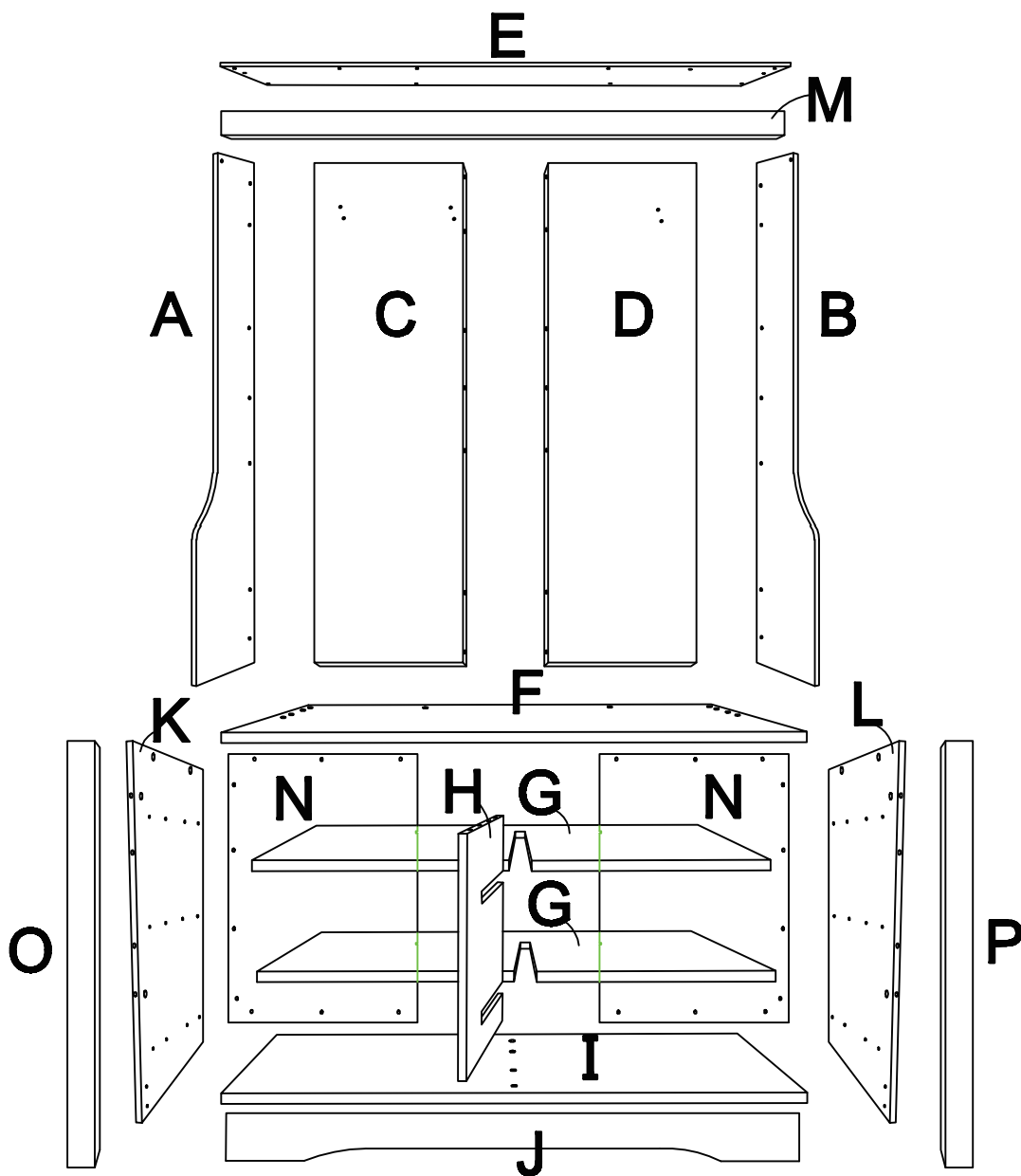

**TOOLS RECOMMENDED**

**PART LIST**



 ②×8

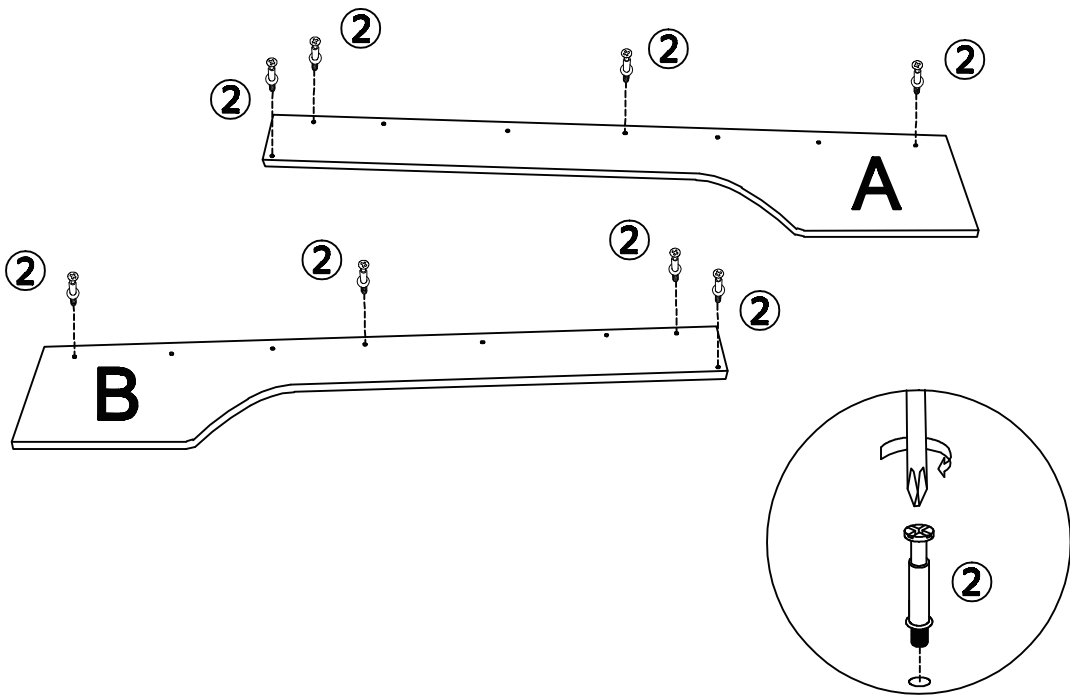

 ④×8

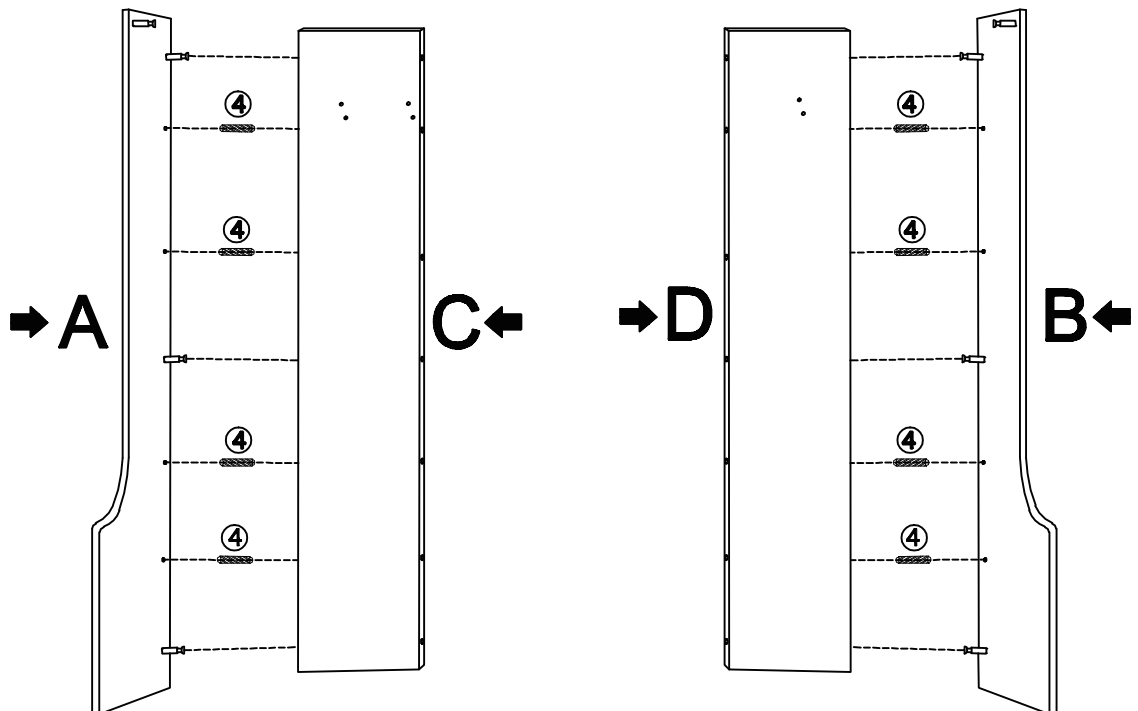

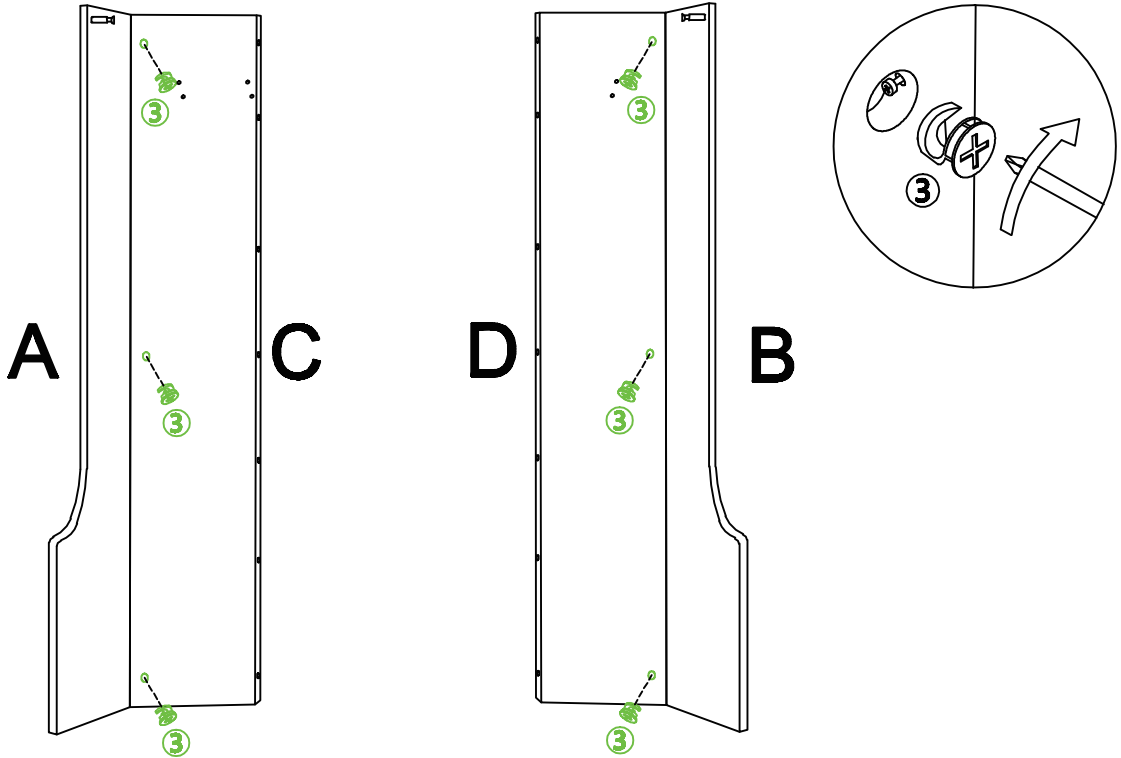

 ③×6



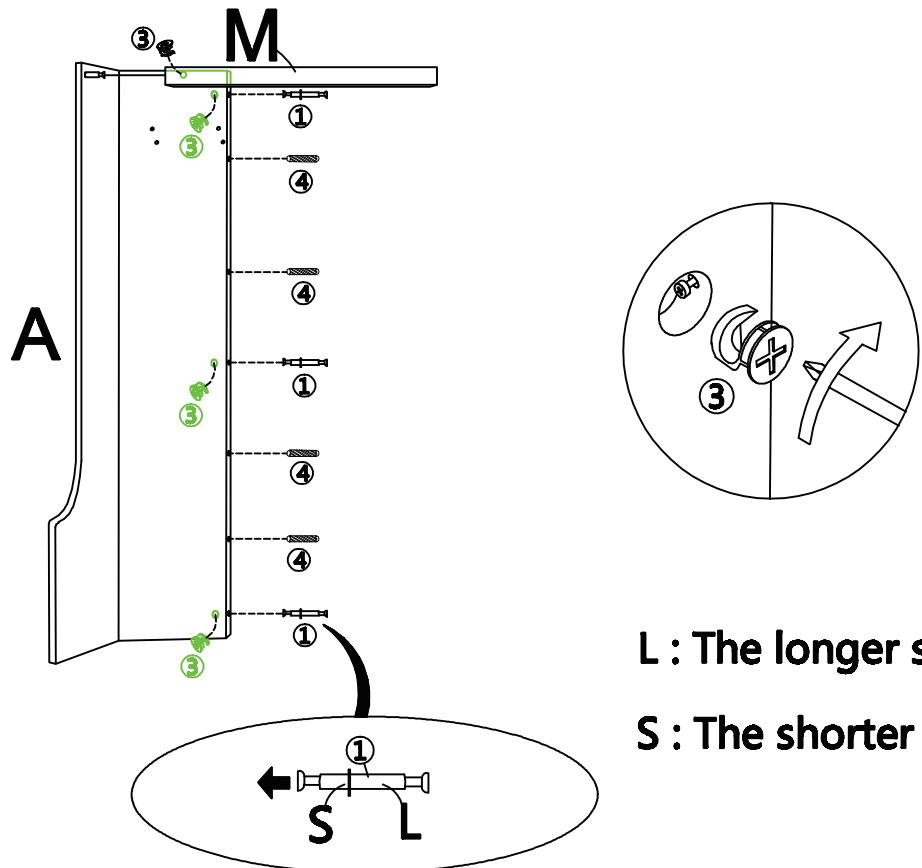

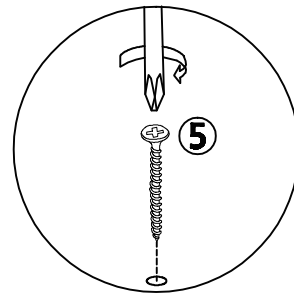
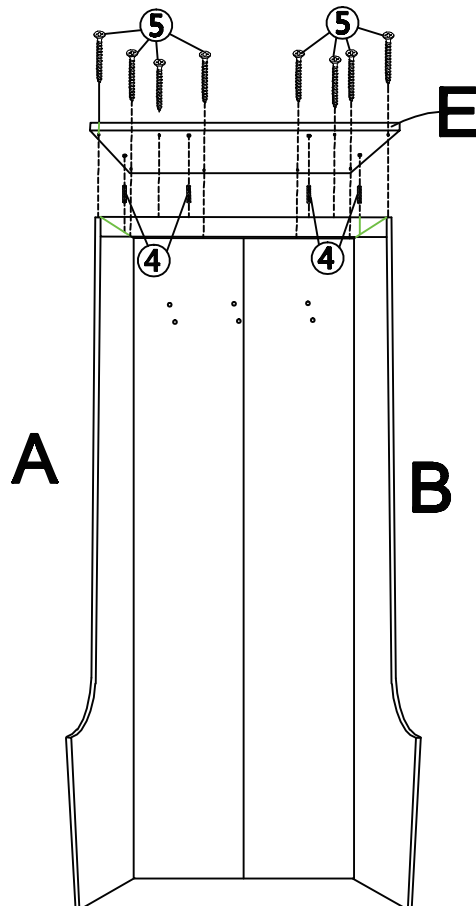
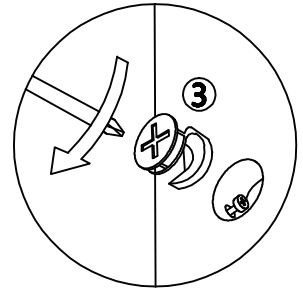
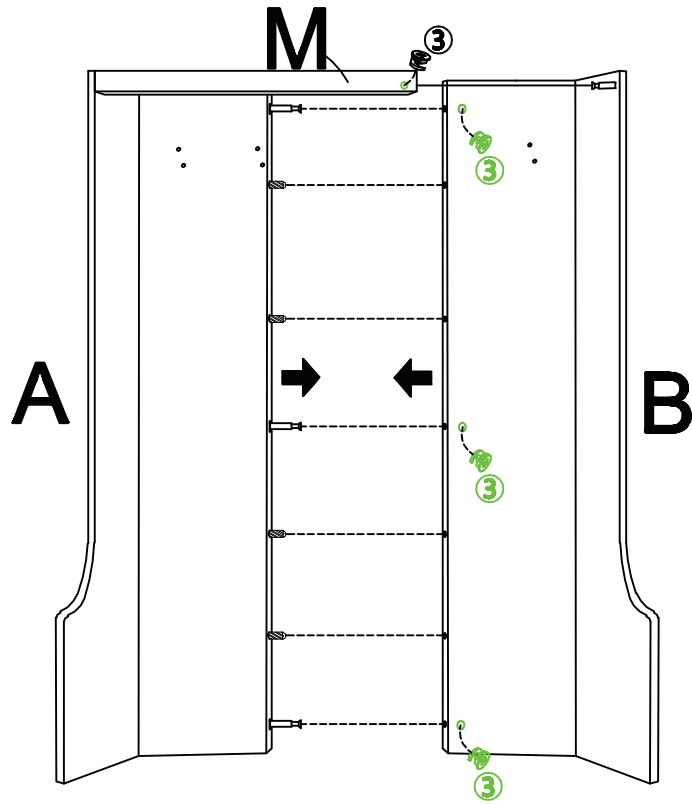
 ①×3     ③×4     ④×4



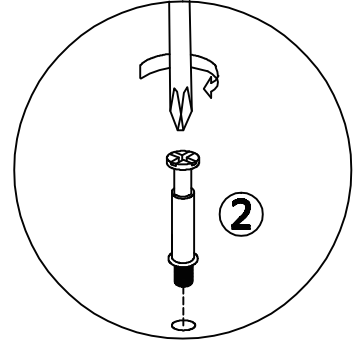
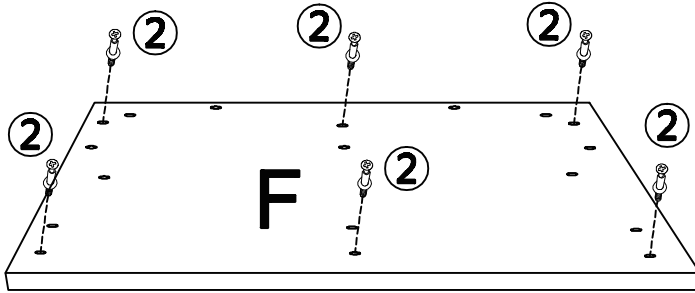

 ②×6



 ⑤×6     ④×4

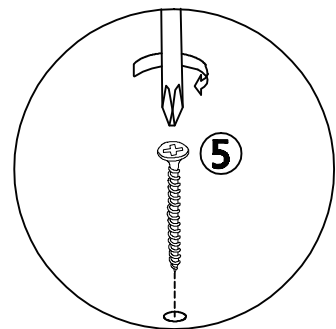
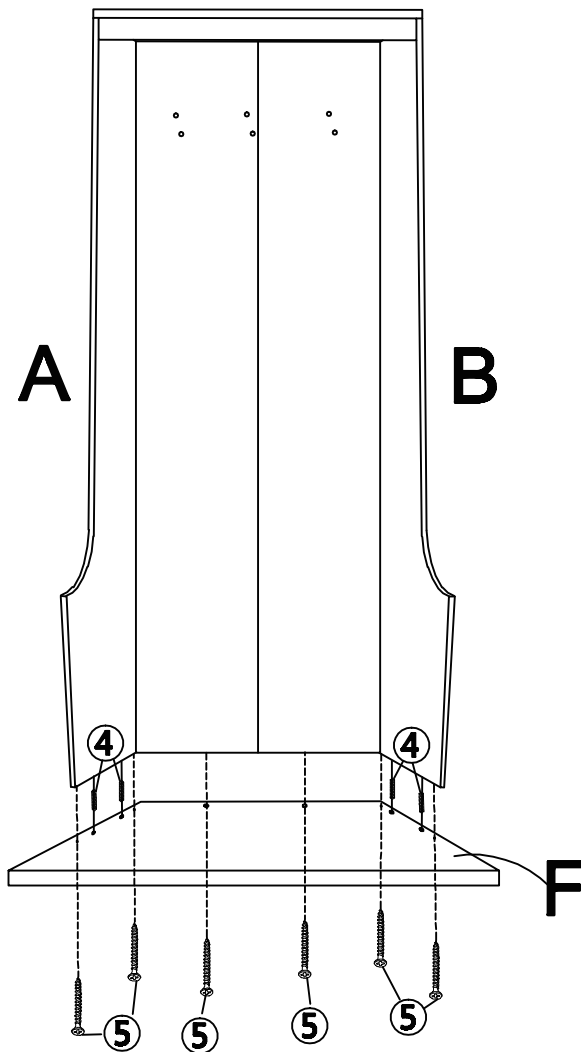

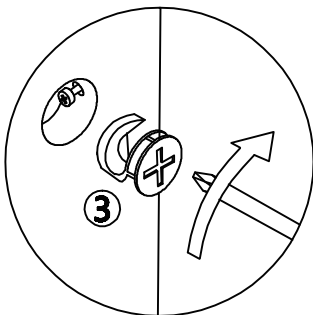
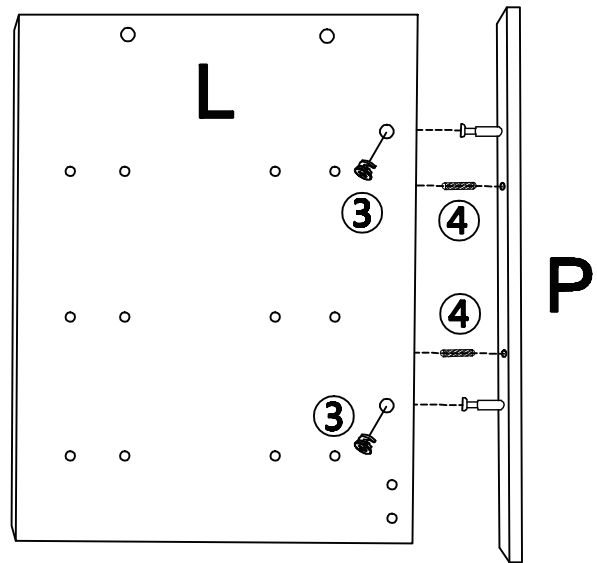
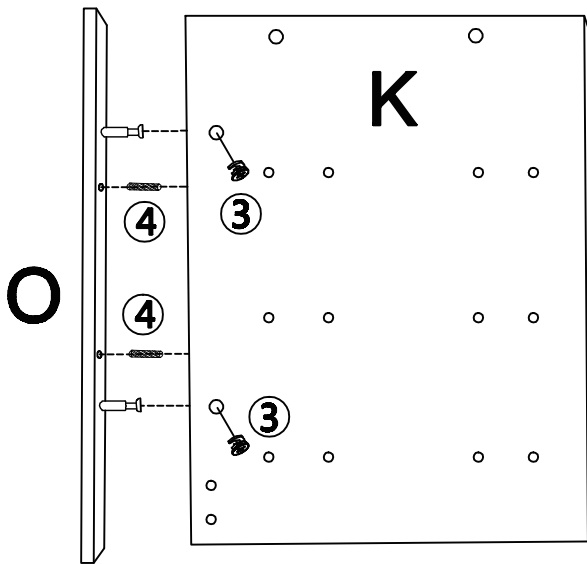
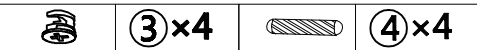
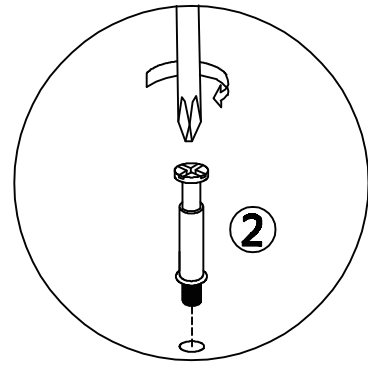
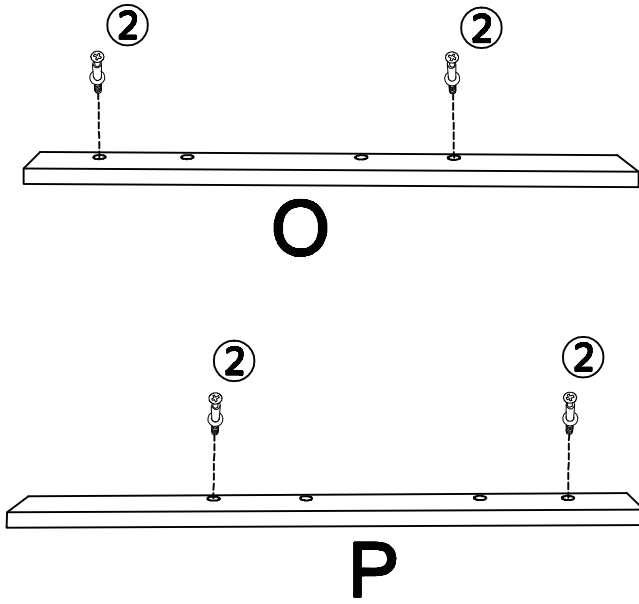



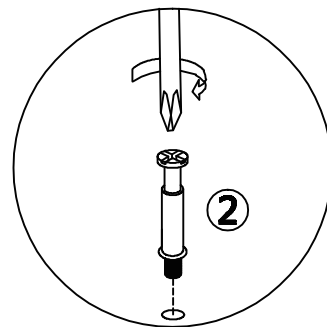
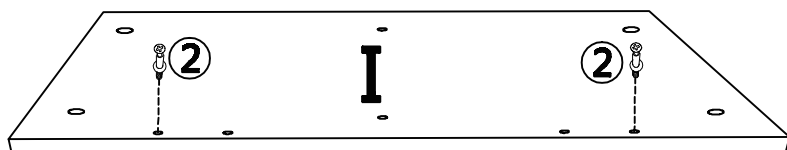
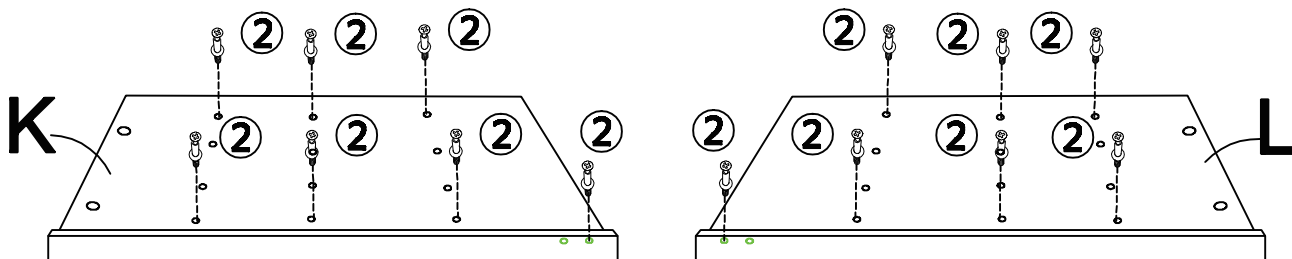

 ②×16



 ⑤×2    
  ④×2

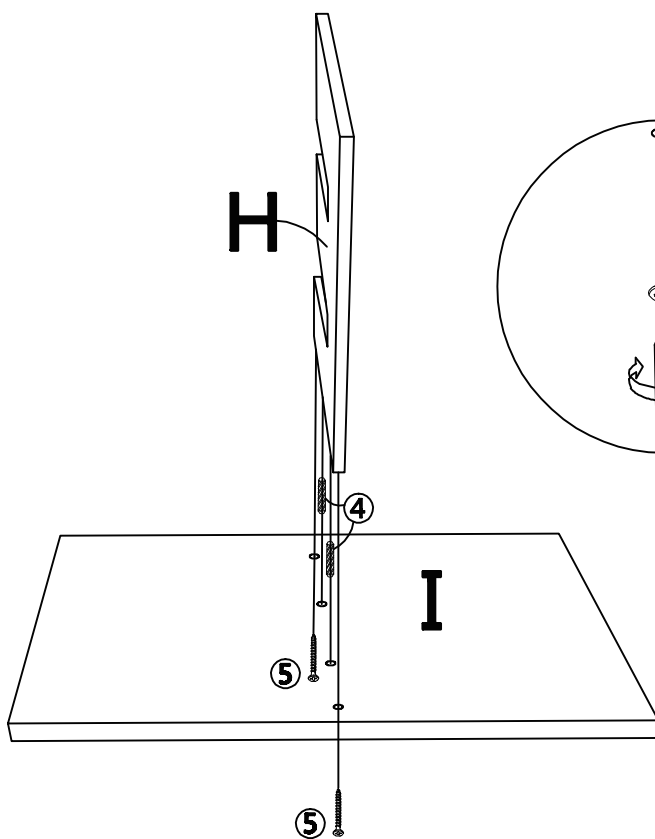

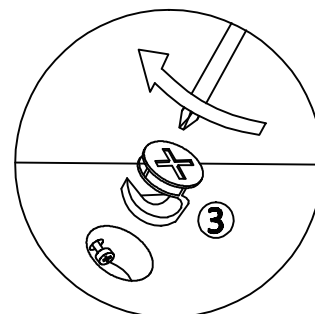
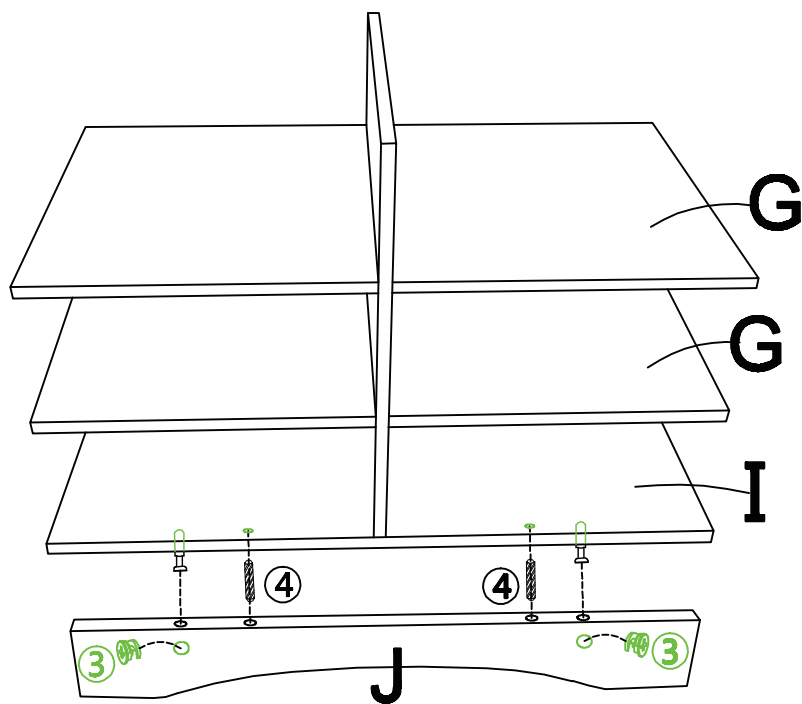
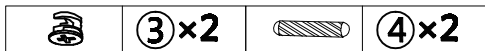
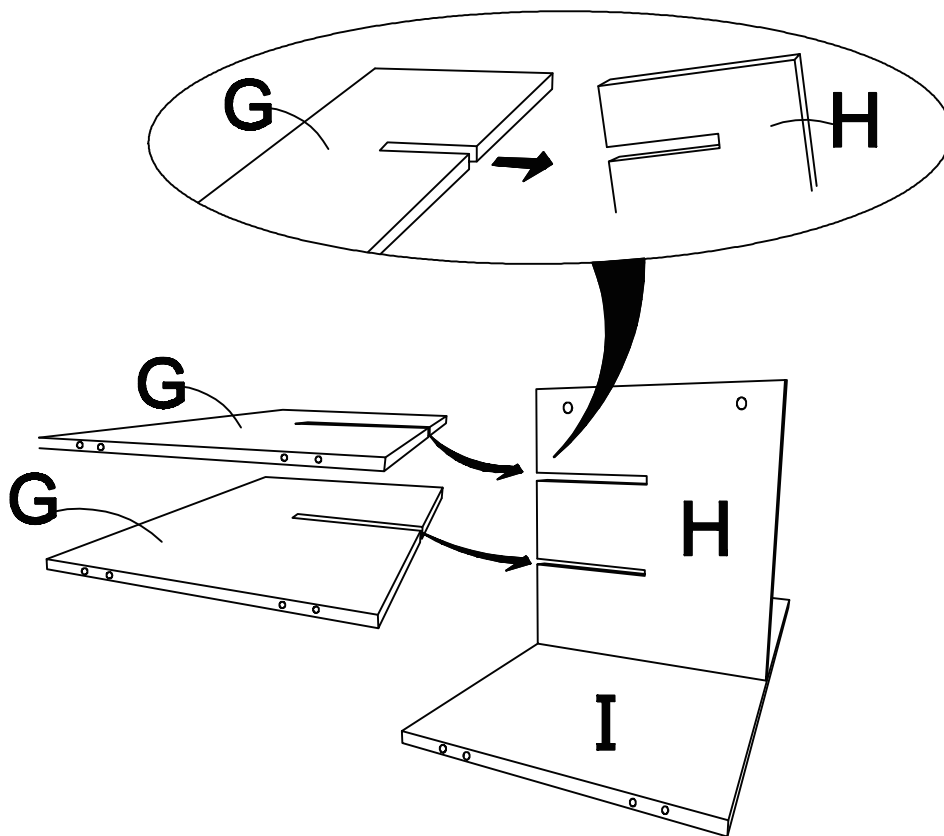

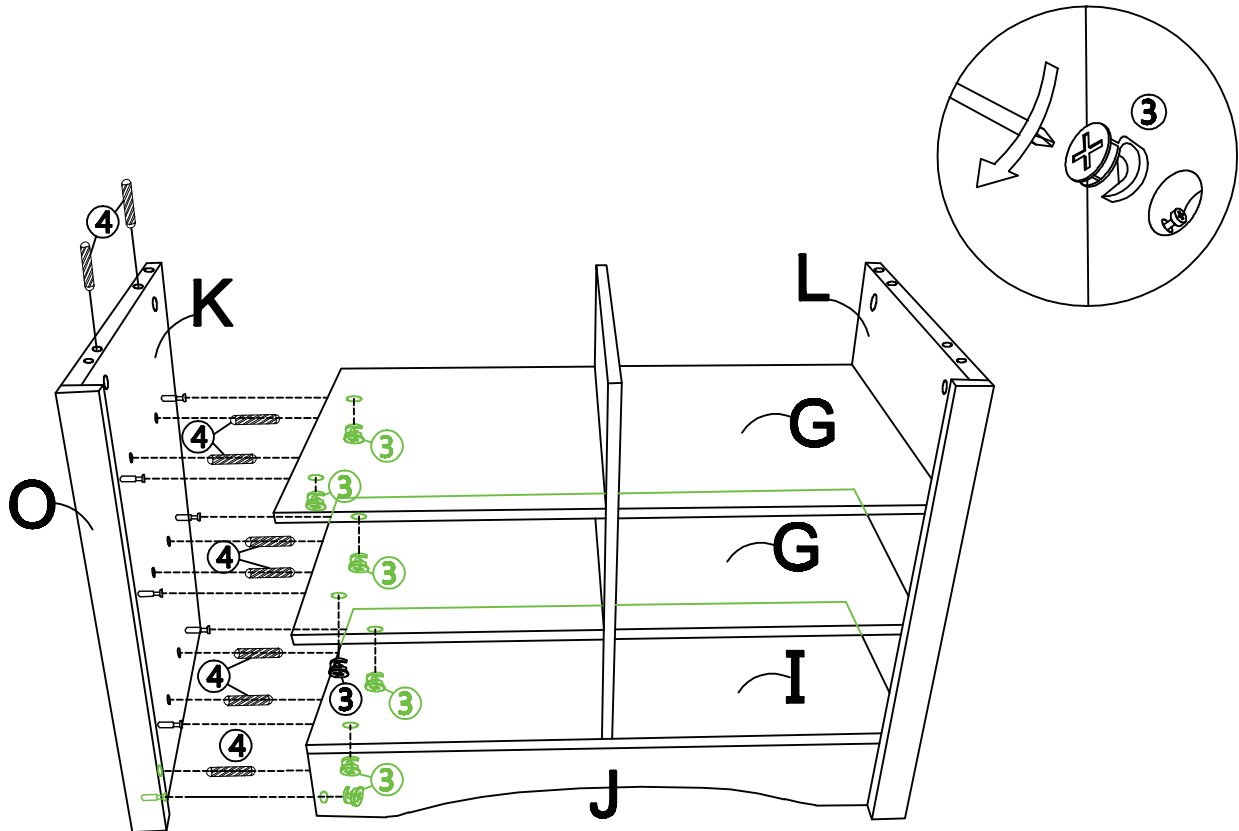
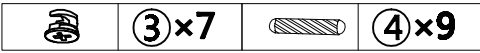
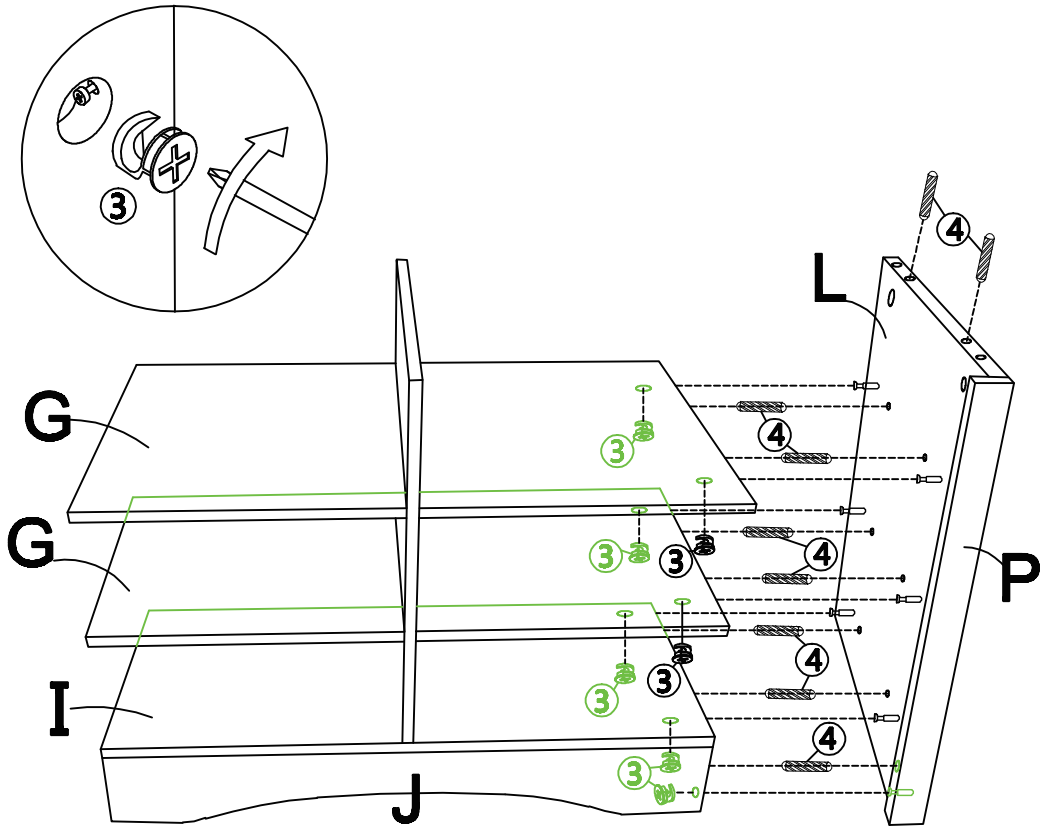
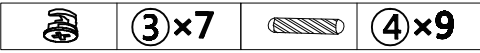

 ③×6

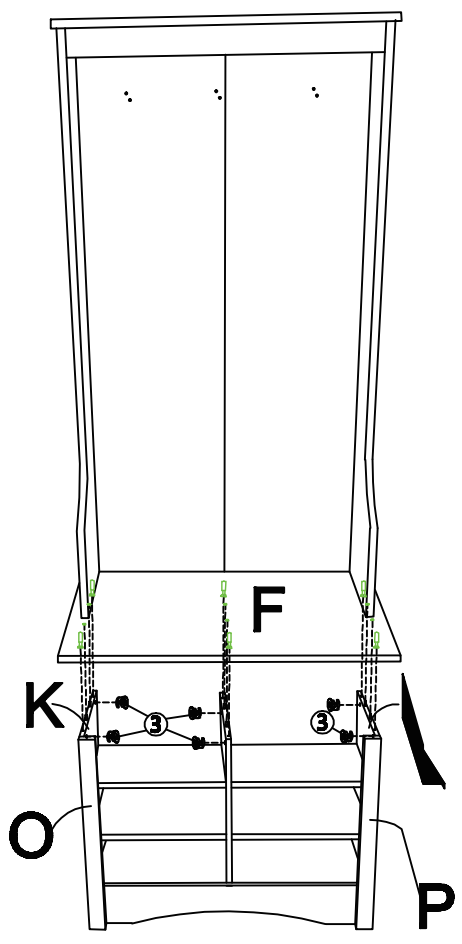
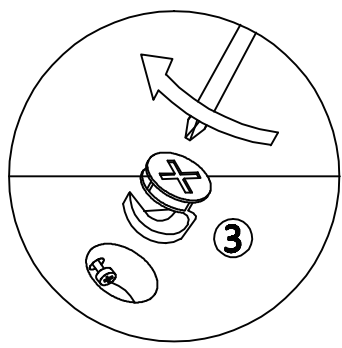

 ⑧×22

