

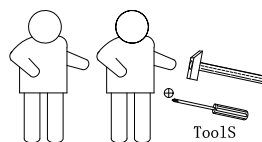

Model:834-044



Step: 1

- A=4 
- C=4 

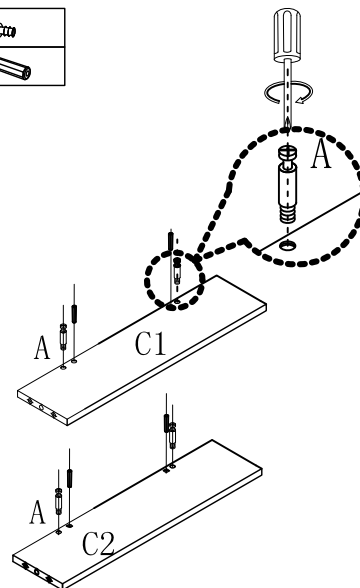

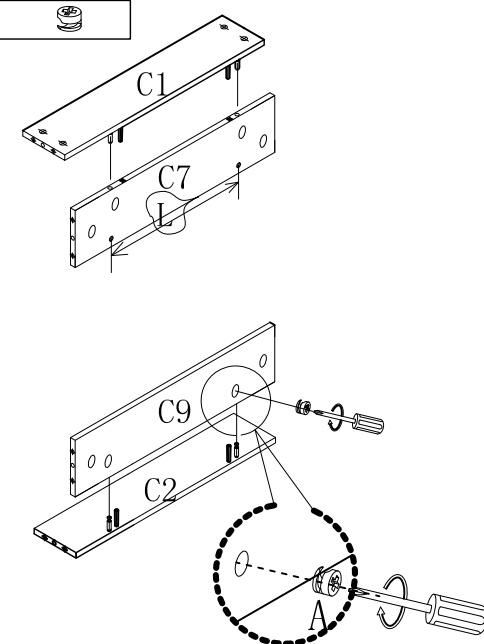

Step: 2

- A=4 



Step: 3

- A=16 
- B=14 

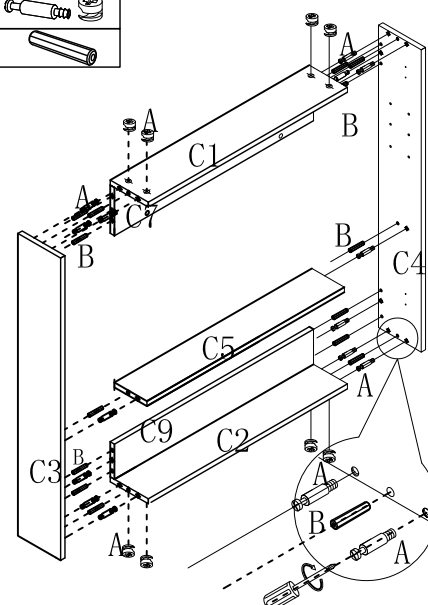



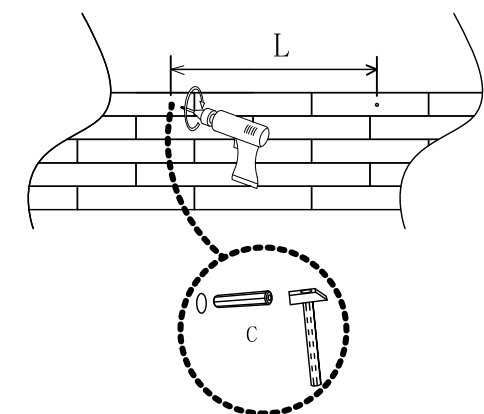

Step: 4

- C=2 

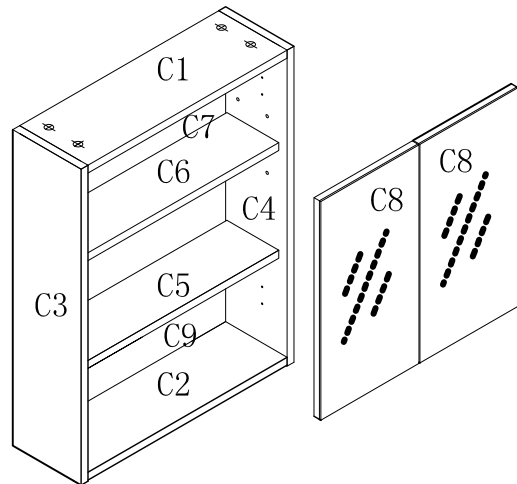

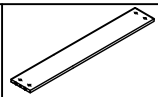
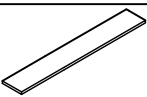
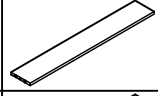
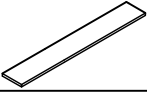
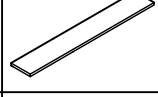

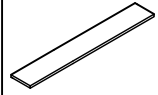





Part List / Figure List



Furniture board listing			
C1=1		C5=1	
C2=1		C6=1	
C3=1		C7=1	
C4=1		C8=2	
C9=1			

Hardware List / Fitting

A=20 	B=18 	C=2 	D=4 	E=2 	F=4 	G=24 	H=12 
	Dowel- ø 8*30mm	ø 6*30mm		ø 6*50mm		ø 4*14mm	ø 18*0.5

Step: 5

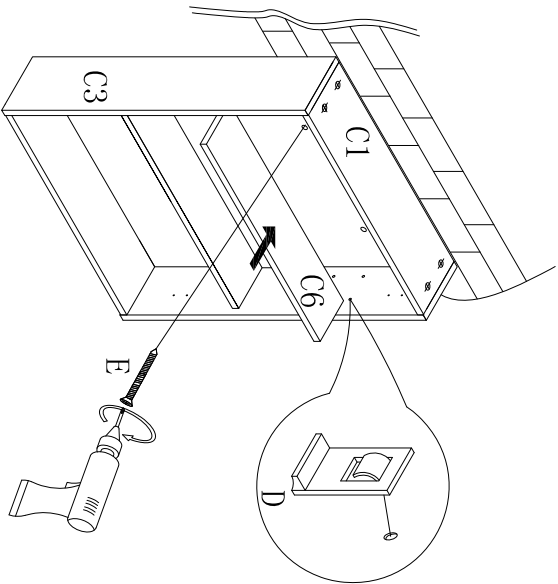
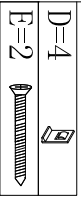

Step: 6

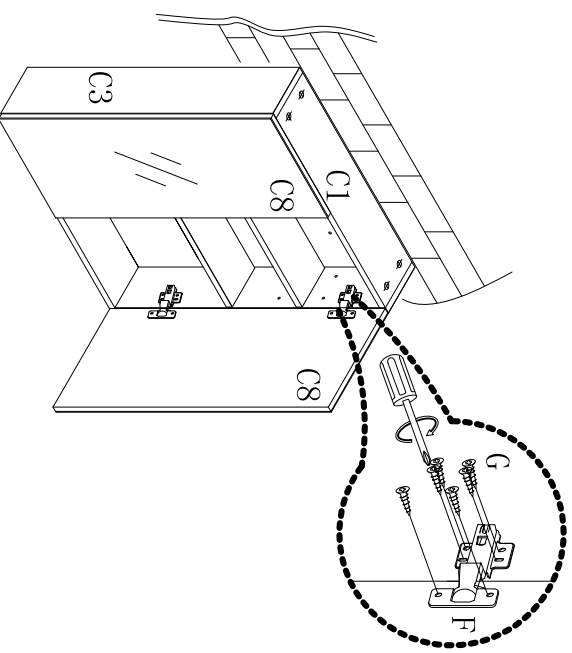
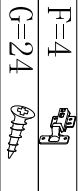

Step: 7

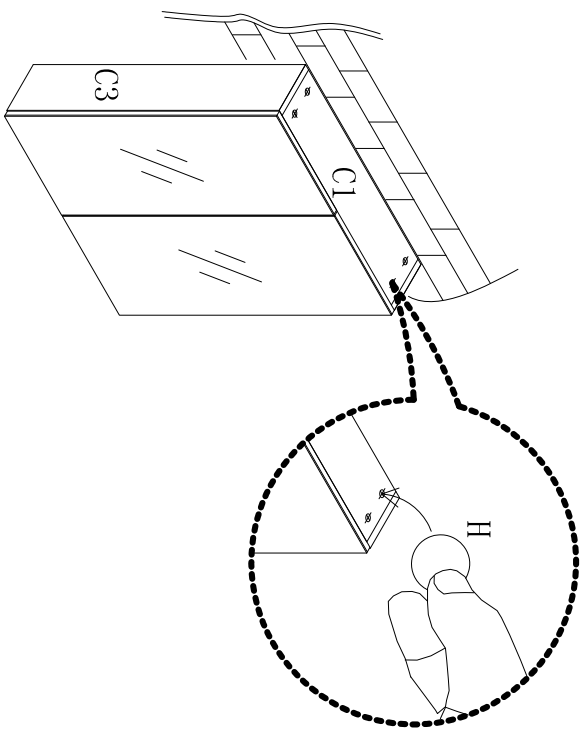

Step: 8

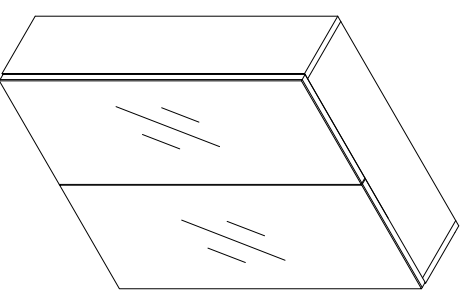

OK!