

*kleanfin*

INcve030\_GL

**834-329**

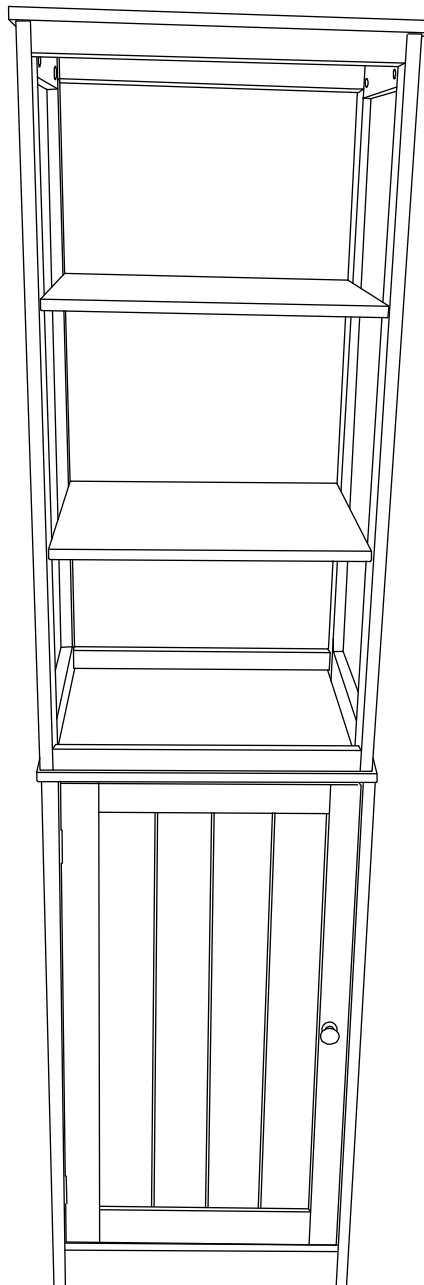

IMPORTANT, RETAIN FOR FUTURE REFERENCE: READ CAREFULLY

**ASSEMBLY & INSTRUCTION MANUAL**

A x 1



B x 1

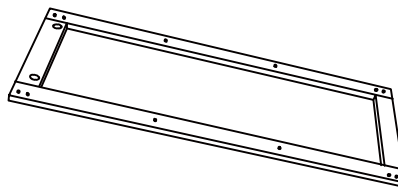

C x 1

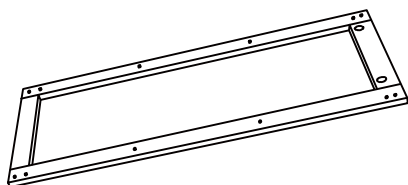

D x 2



E x 1

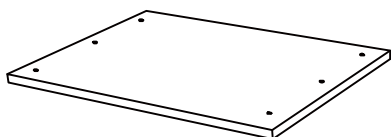

F x 1



G x 1

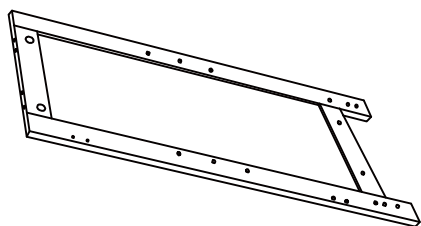

H x 1

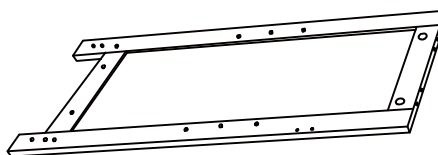

I x 1

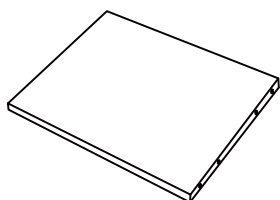

J x 2

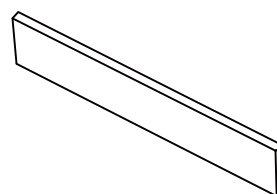

K x 1

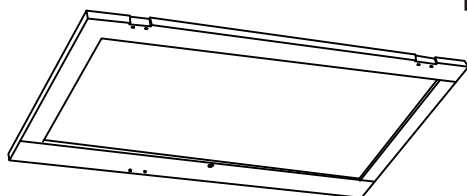

L x 2

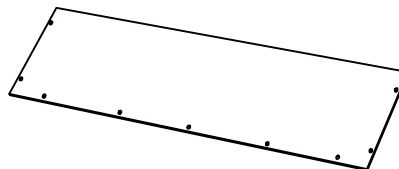

M x 1



N x 3

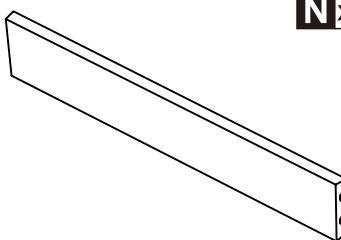

O x 1

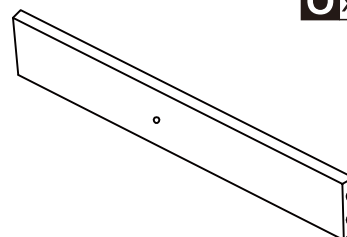

**a** x28

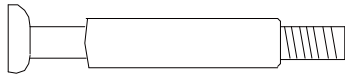

**b** x28

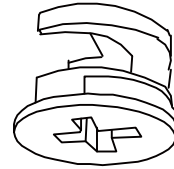

**c** x30

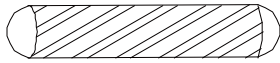

**d** x 4  
M4\*35



**e** x13  
M3\*12

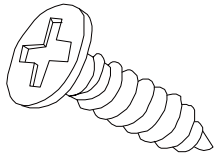

**f** x 1



**g** x 2

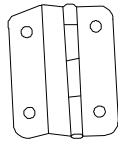

**h** x 1  
M4\*16

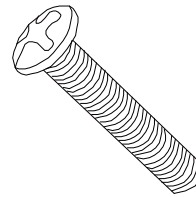

**i** x 1

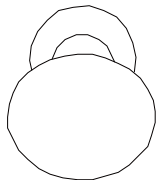

**j** x 1

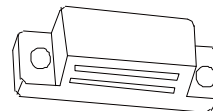

**k** x 4

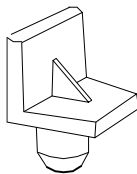

**l** x18  
M2\*10

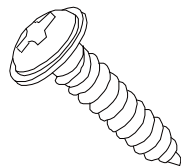

**m** x 1

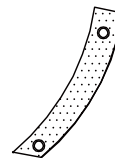

**n** x 1  
M4\*40



**o** x 1

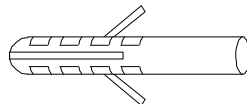

**p** x 1

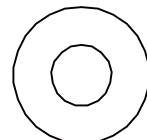

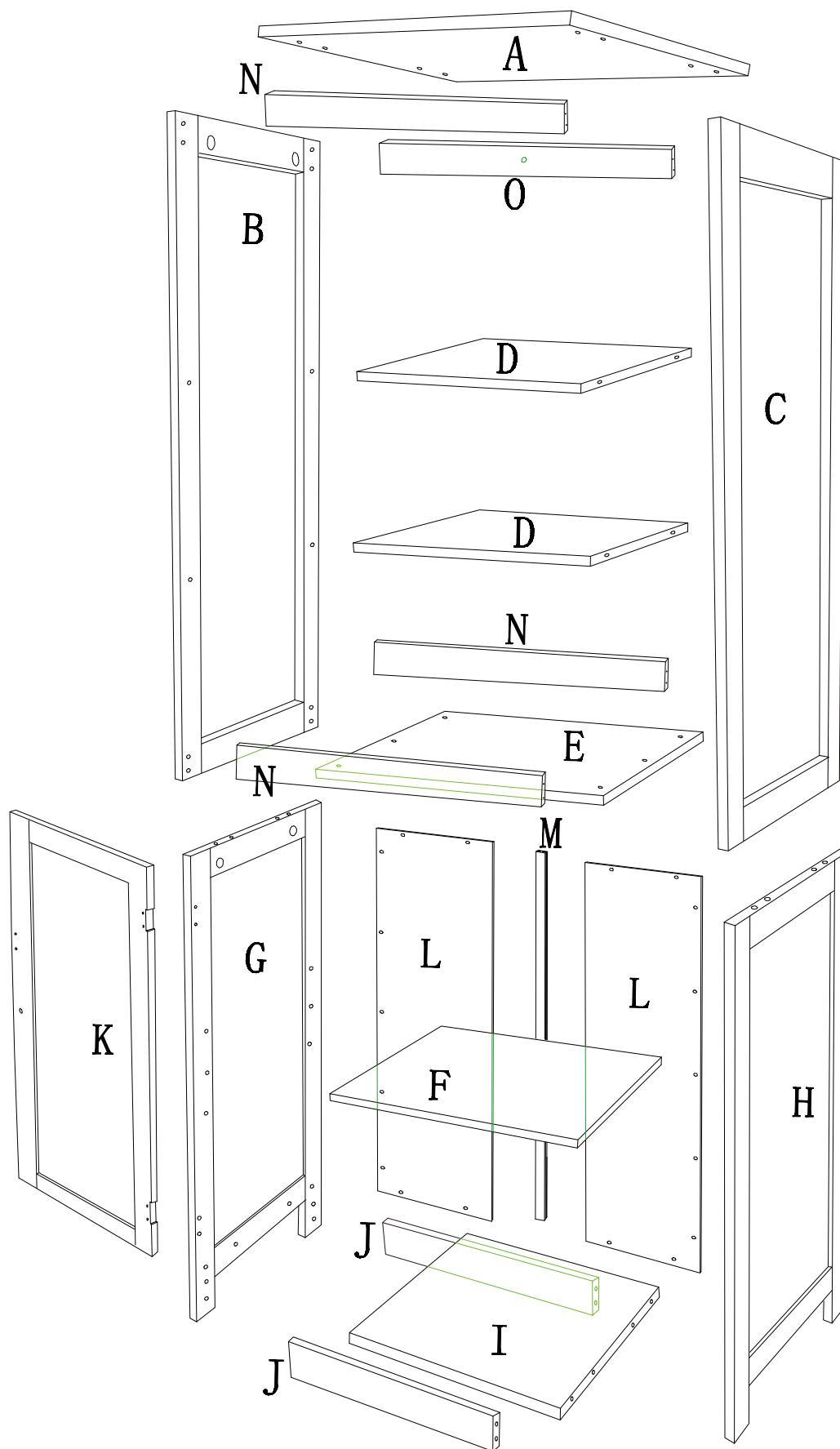

ax24

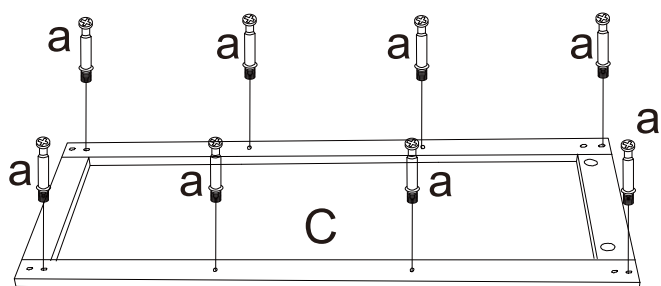
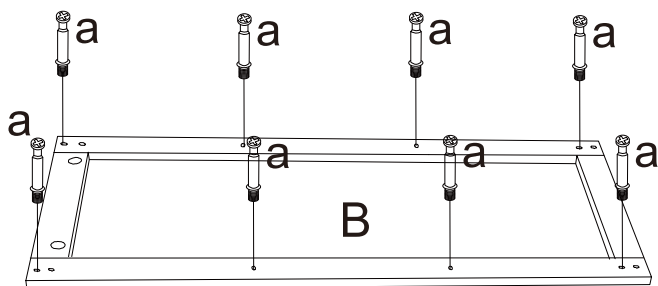
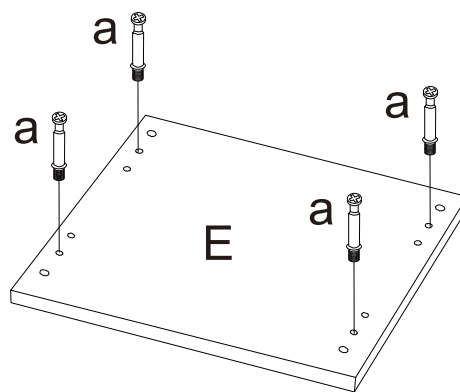
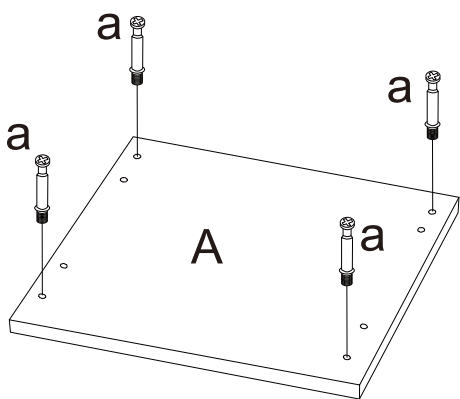

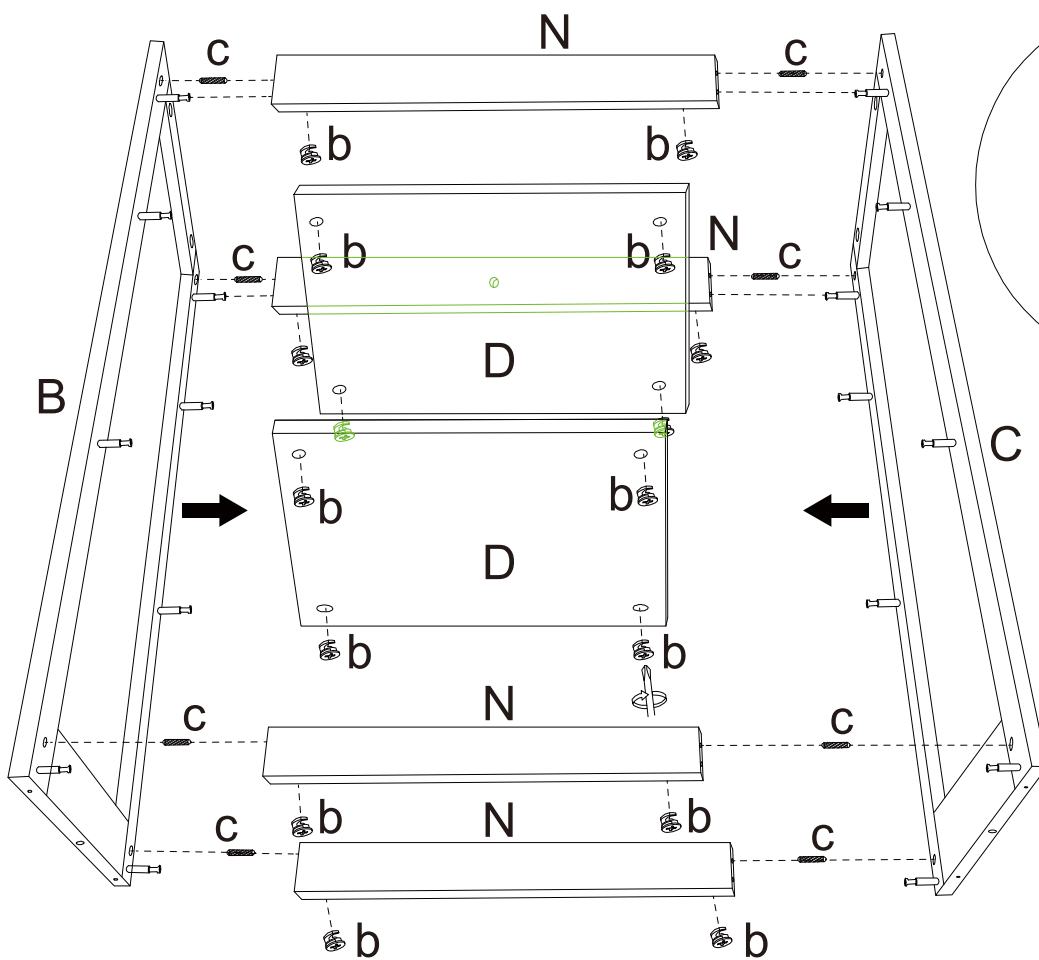

bx16 cx8

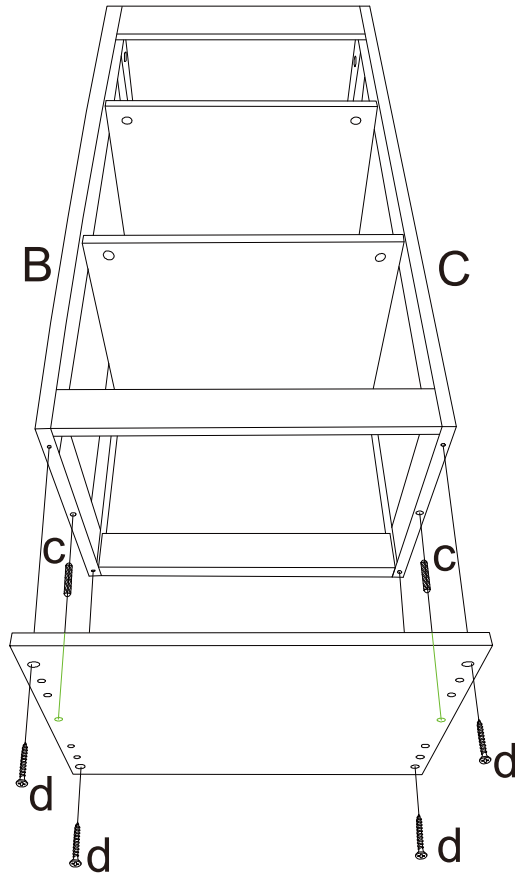

 cx2    dx4





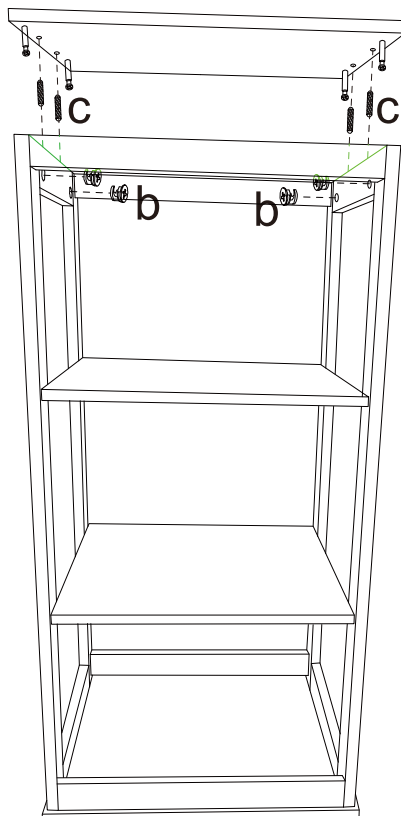

 bx4    cx4

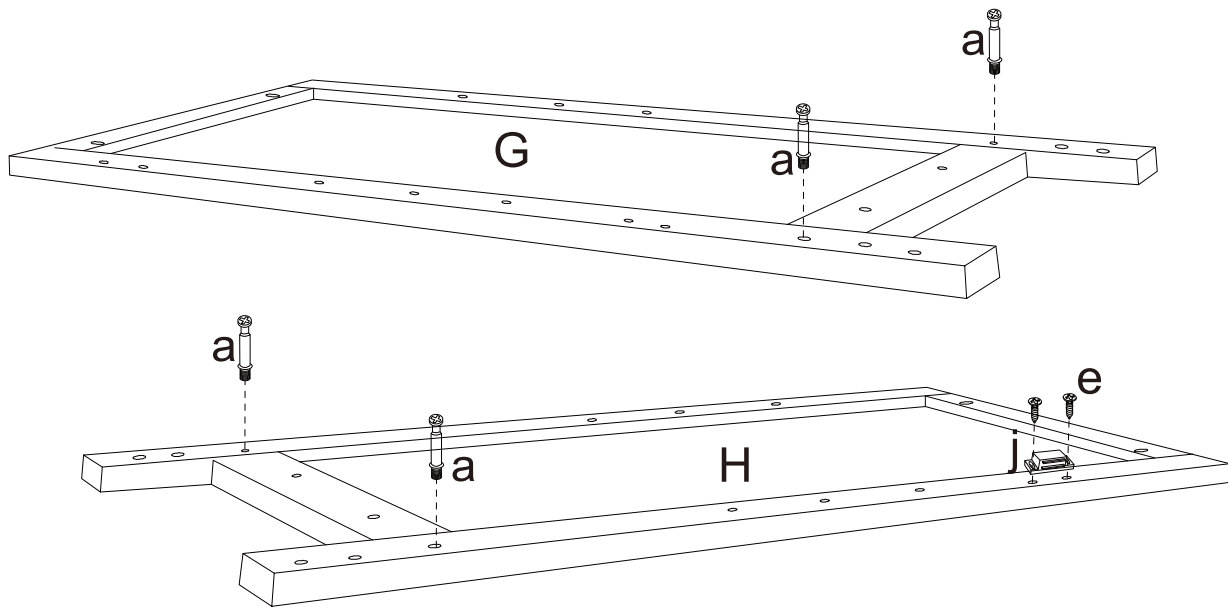

	ax4		ex2		jx1
---	-----	---	-----	---	-----



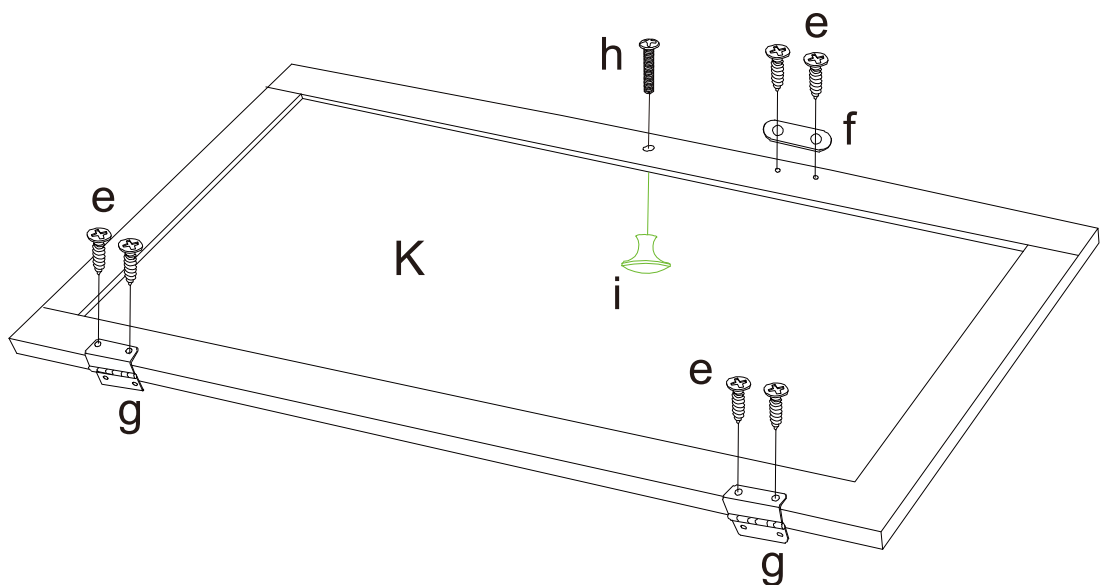

	ex6		fx1		gx2		hx1		ix1
---	-----	---	-----	---	-----	---	-----	---	-----



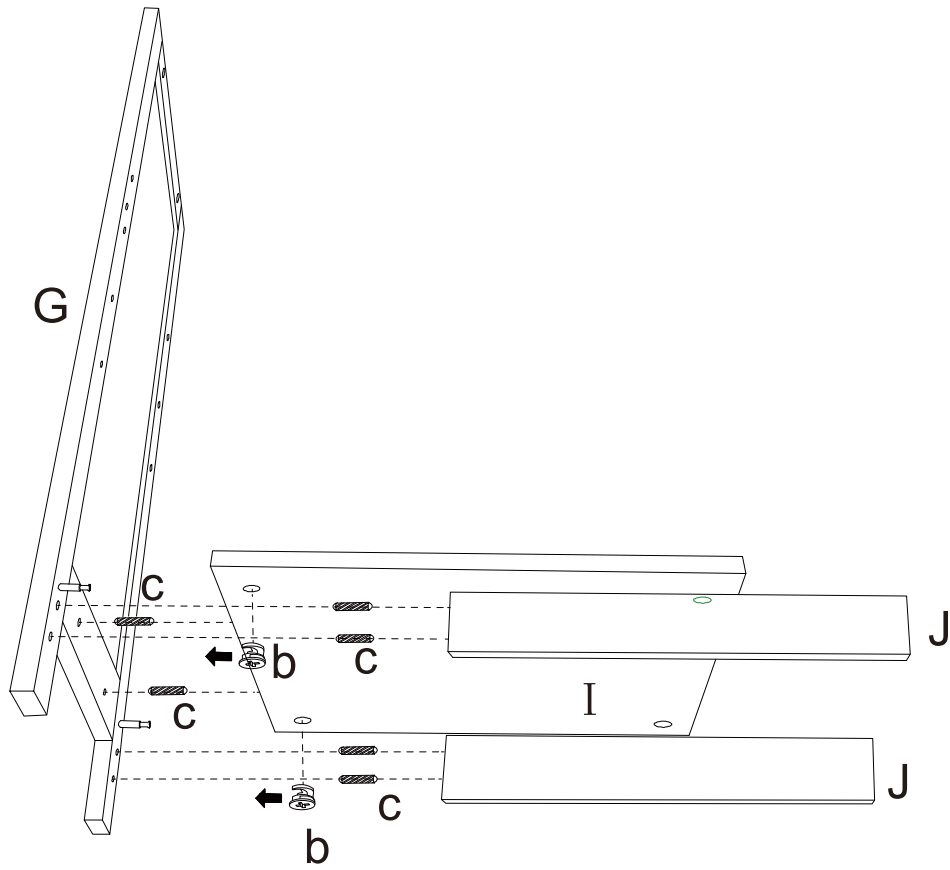

	bx2		cx6
---	-----	---	-----

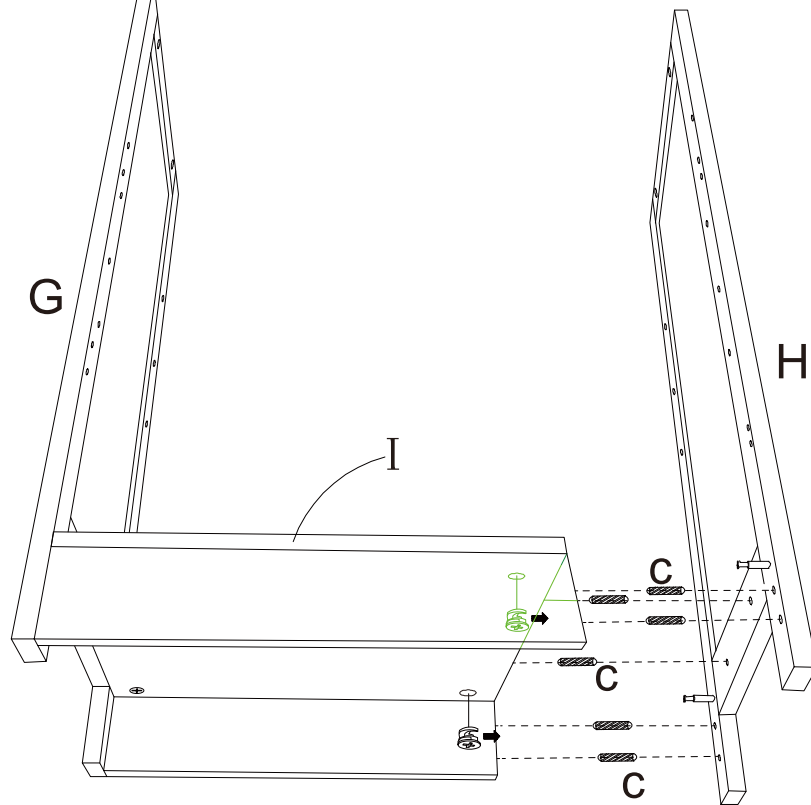

	bx2		cx6
---	-----	---	-----





-  bx4
-  cx4

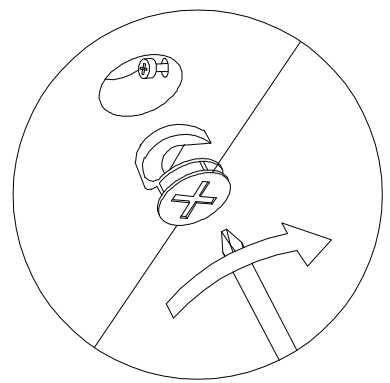
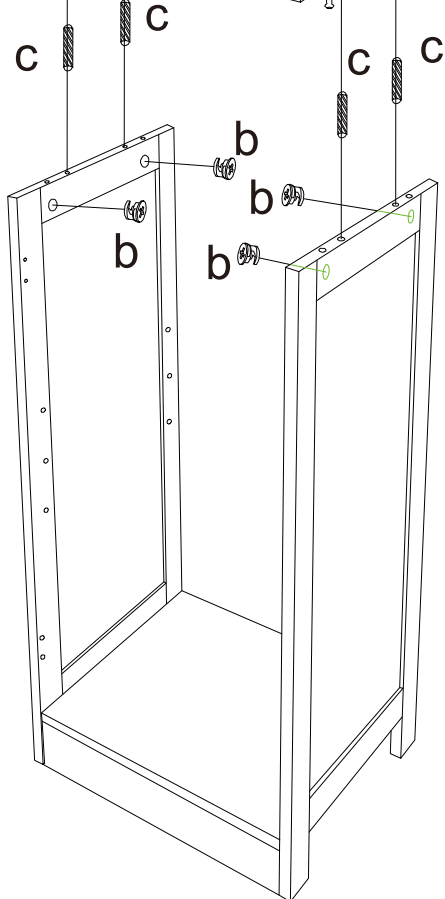
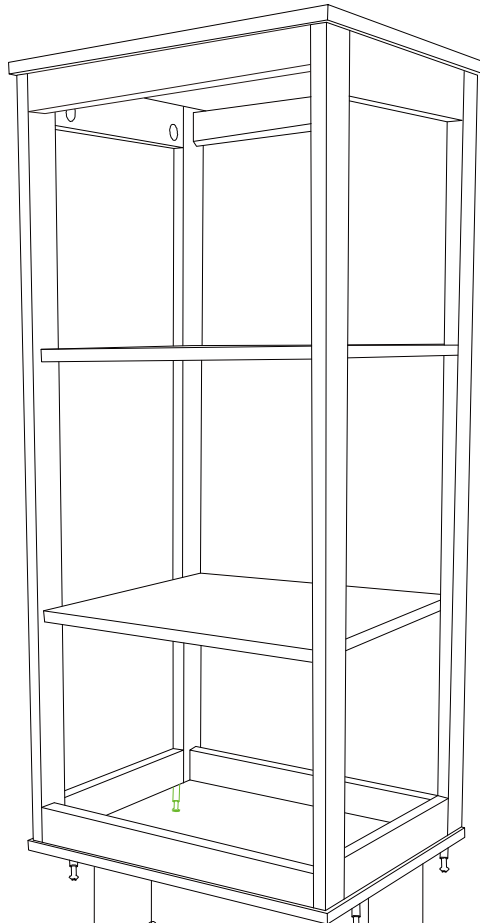

-  lx18
-  ex1
-  mx1

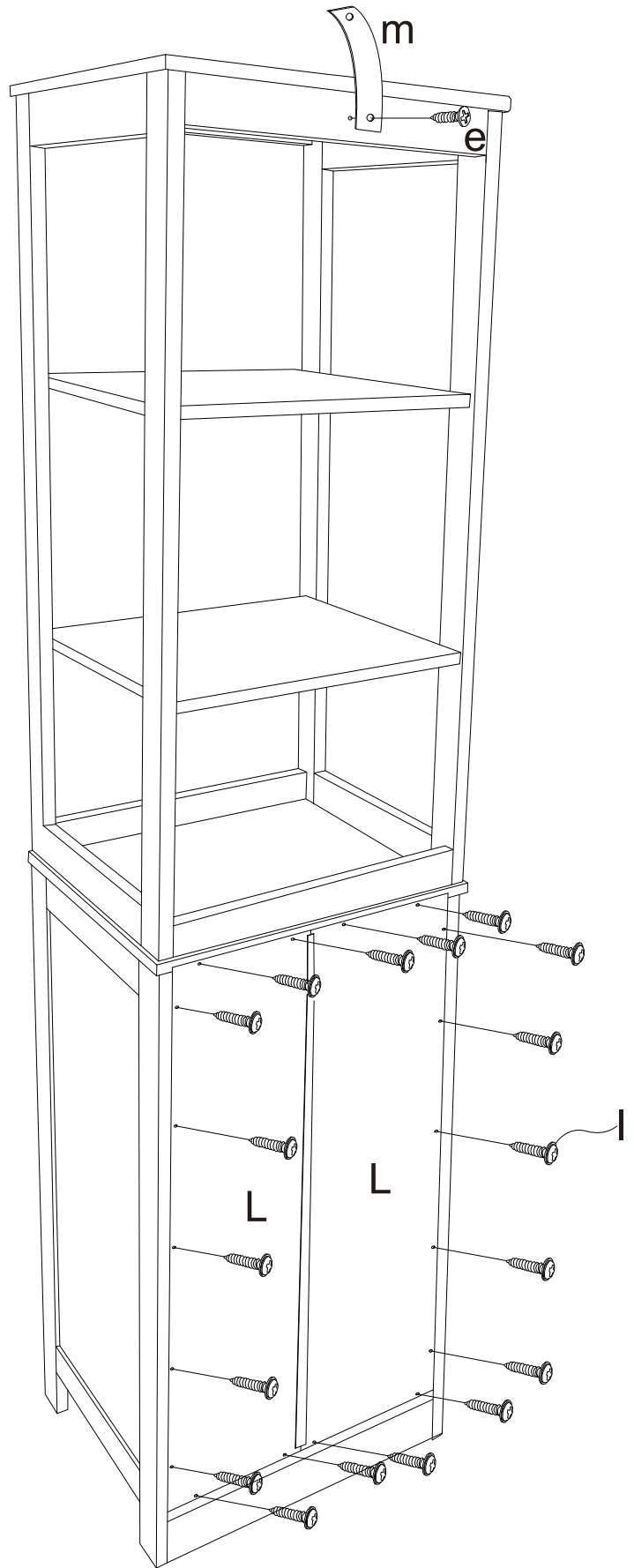
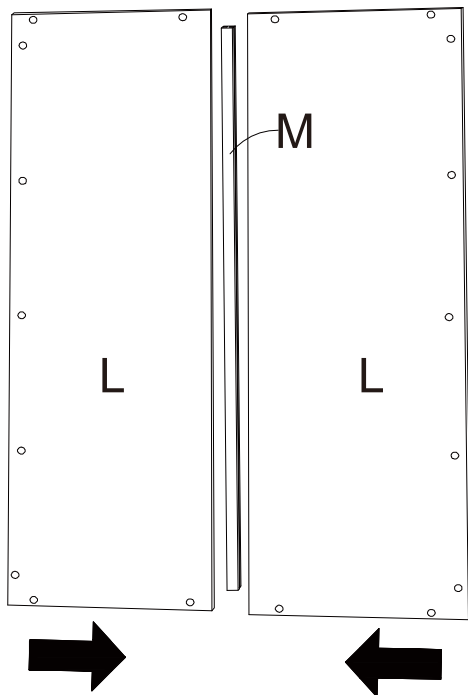

 ex4

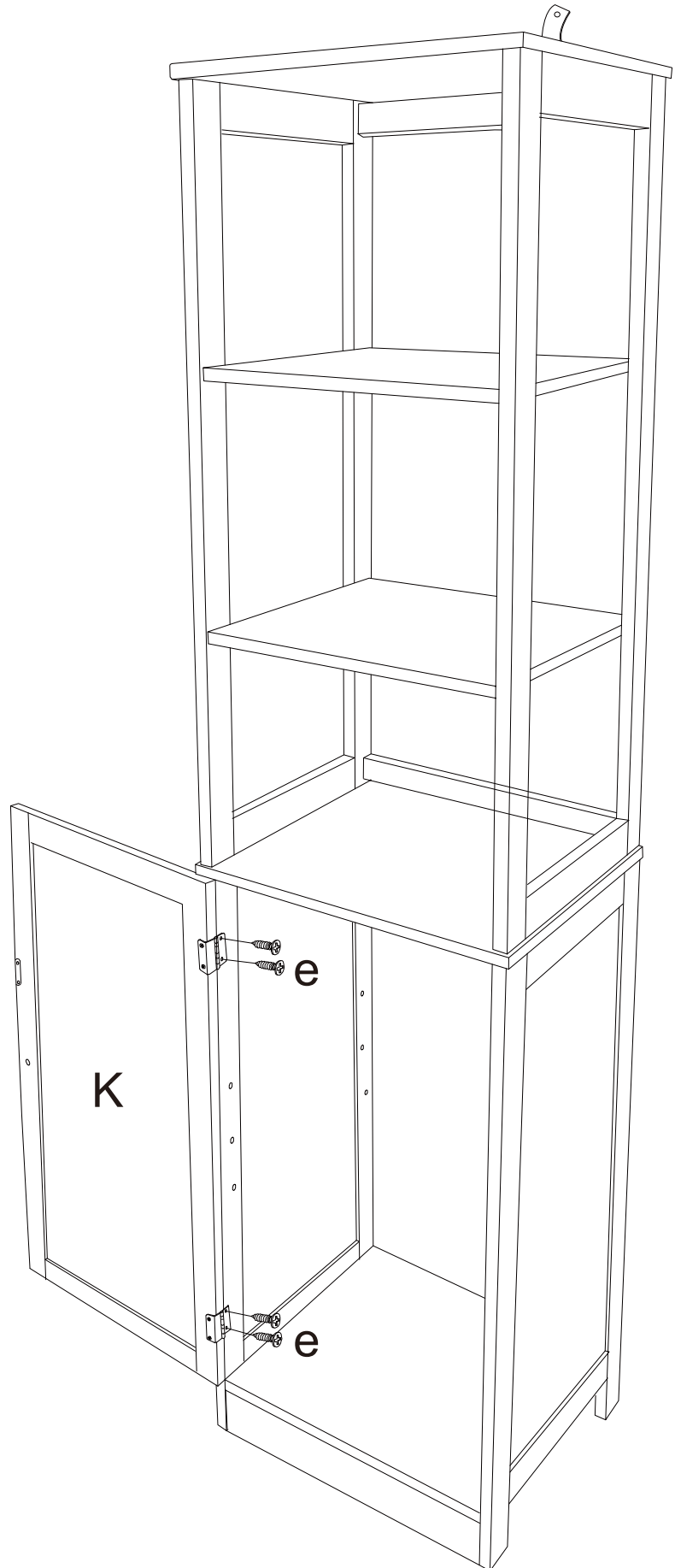

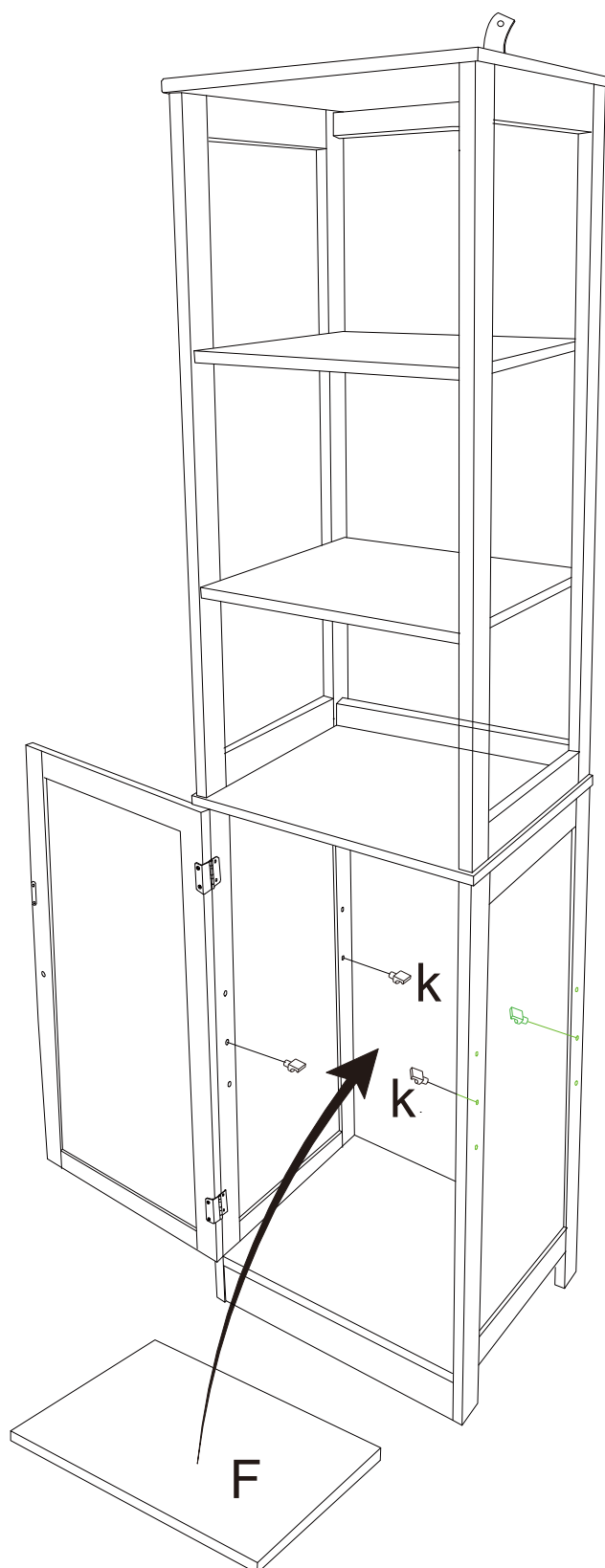
 kx4

- |   |     |   |     |   |     |
|---|-----|---|-----|---|-----|
|  | nx1 |  | ox1 |  | px1 |
|---|-----|---|-----|---|-----|

