

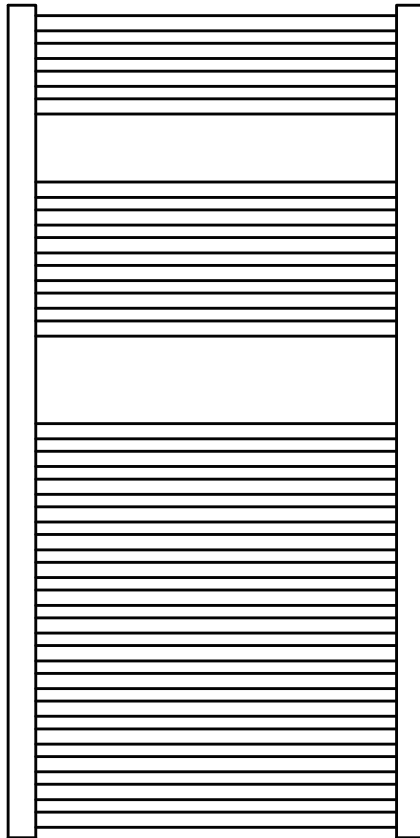

INcvf008V01_UK

850-227V00

Rail Radiator



IMPORTANT, RETAIN FOR FUTURE REFERENCE: READ CAREFULLY

UESR'S MANUAL

Unit: mm

600±1.5%

1200⁺⁶₋₂

25 Pipes Ø22 Tube

2 Pipes 40x30xR15 D Profile

22-40

550

4-G1/2"

55⁺³₋₁

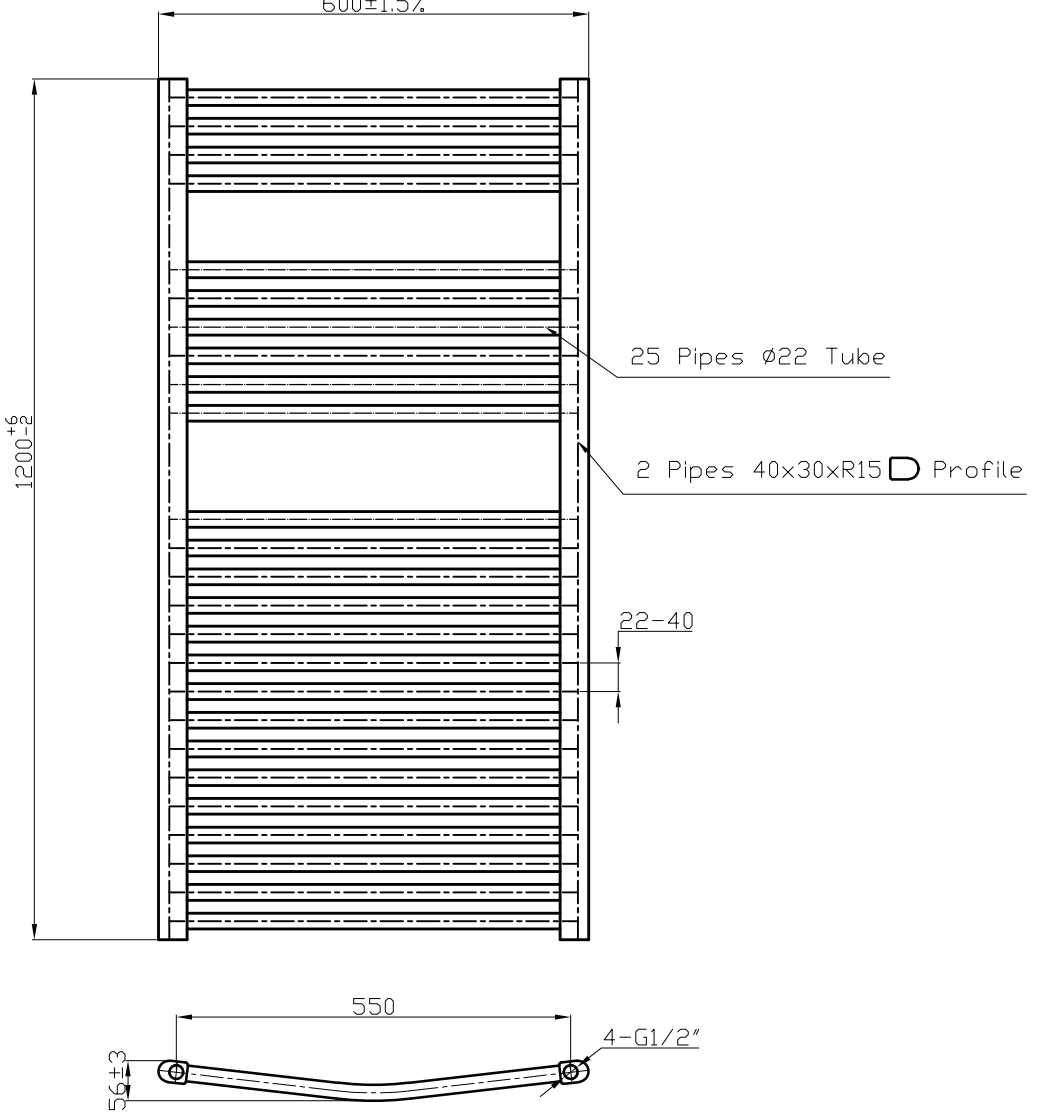

Dear customer,





Thank you for purchasing this product. For you to protect and install this appliance properly, please read the manual thoroughly before using. Keep this manual safe for future reference.

1. Product features

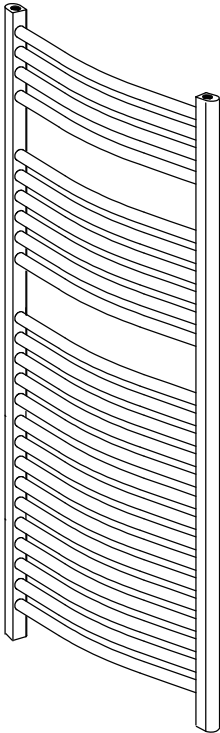
Pictures in this manual is for reference only – always refer to the actual product. If you have any questions about the product and its features, please contact customer service.

2. Accessory checklist



	Blanking Plug	x1
	Air Vent	x1
	Washer	x4
	Long Screw	x4
	Masonry Wall Plug	x4
	Cap	x4
	Barcket Bush	x4
	Cross Bolt	x4
	Spacer	x4
	Wall Support	x4







3. Installation notes

- 1) Installation must be completed by a qualified person.
- 2) Dispose of all packaging in a responsible manner.
- 3) For installation, ensure the wall can hold the weight of this product. A brick or cinderblock type wall is suitable.
- 4) This product is for indoors only.
- 5) Use a tape measure to insure there is enough space to fit this product.

4. Towel rail installation:

- Read instructions carefully before installation.
- Installation must be completed by a qualified person.
- Dispose of all packaging in a responsible manner.

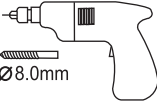

Tools required

Phillips screwdriver 	PTFE tape(not supplied) 
Slotted screwdriver 	Active spanners 
Marker pen 	Electric drill 8mm Drill Bit  Ø8.0mm
Tape Measure 	

Apply PTFE tape (not supplied) to the blanking plug – insert them into the top left threaded holes. Apply PTFE tape (not supplied) to the air vent plug – insert them into the top right threaded holes.

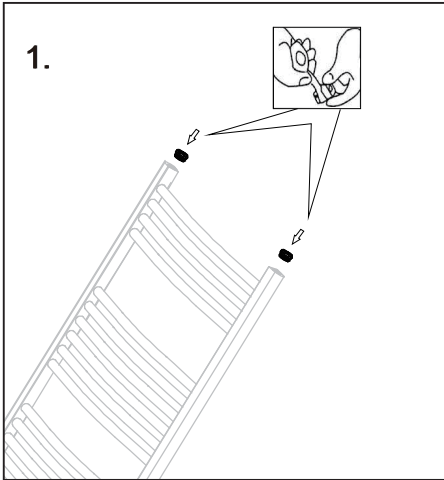
1.



	Blanking Plug	x1
	Air Vent	x1
	PTFE tape(not supplied)	x1

2.

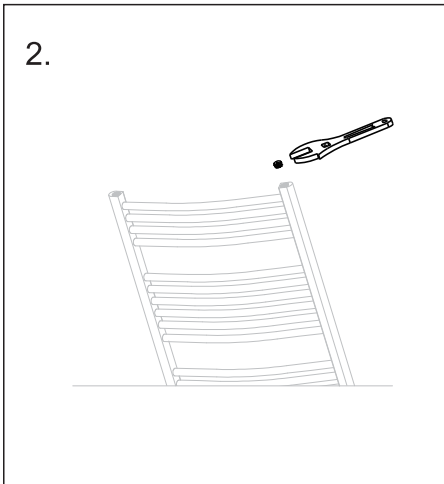

Use a wrench to secure the blanking plug and air vent.

Mark the position of the wall bracket screws with a pencil, then drill 8mm holes into the marked position.
Tap the masonry wall plug into the hole.

Secure to the wall using a long screw, washer and spencer in that order (hole facing out). See picture below.

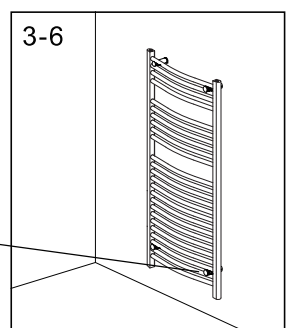
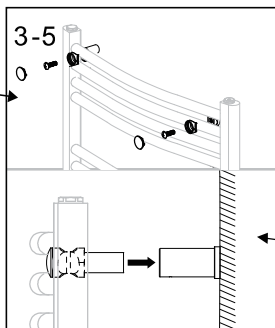
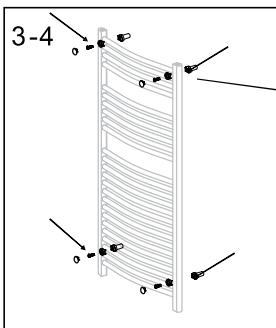
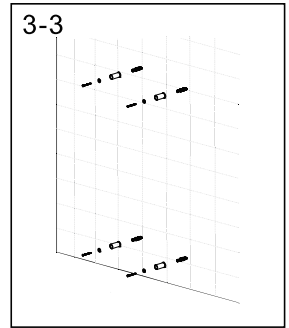
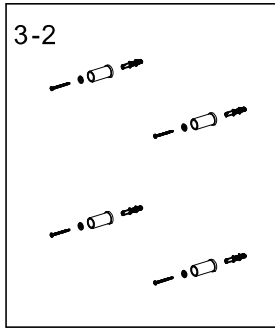
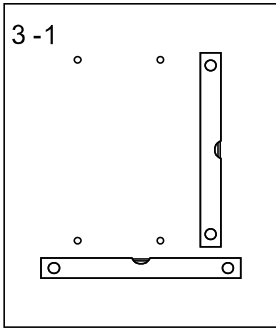
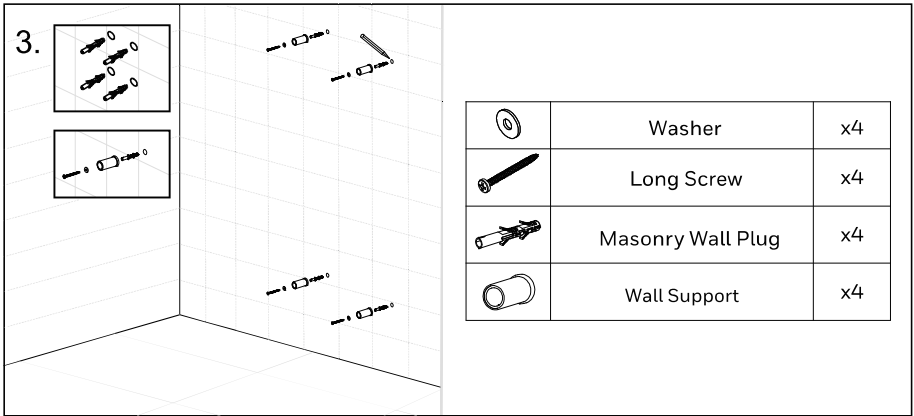

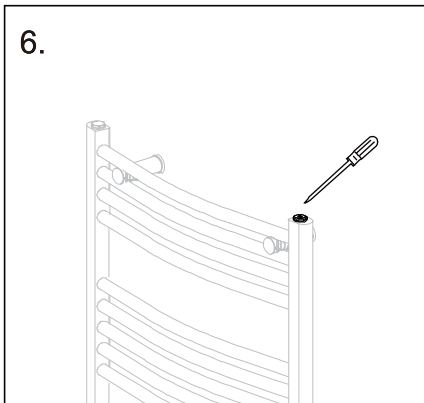
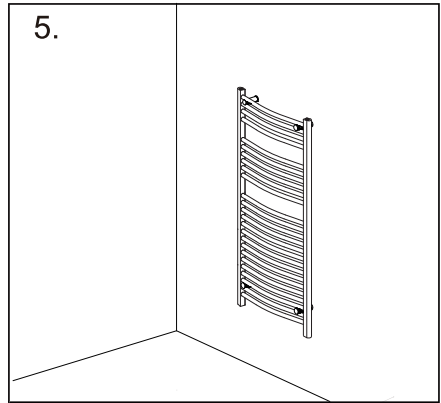
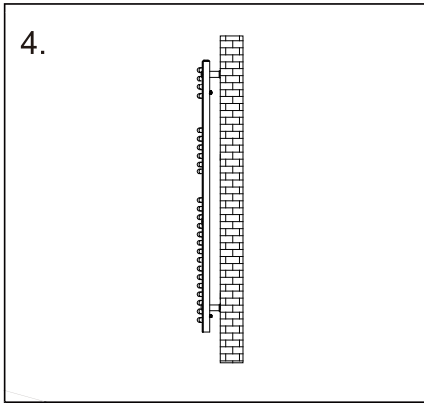

After installation:

- Use a screwdriver to open the air vent, open the valve and let the water flow into the product. Check all connection points for possible leaks.
- Once the water flows from the air vent, there will be no air in the tube.
- Use a screwdriver to close the vent, then turn on the valve – the product is ready to use.

Attention!

- Inspect the heater regularly. If you find any leaks, close the main valve straight away.
- Be cautious of hot water to prevent scalding.

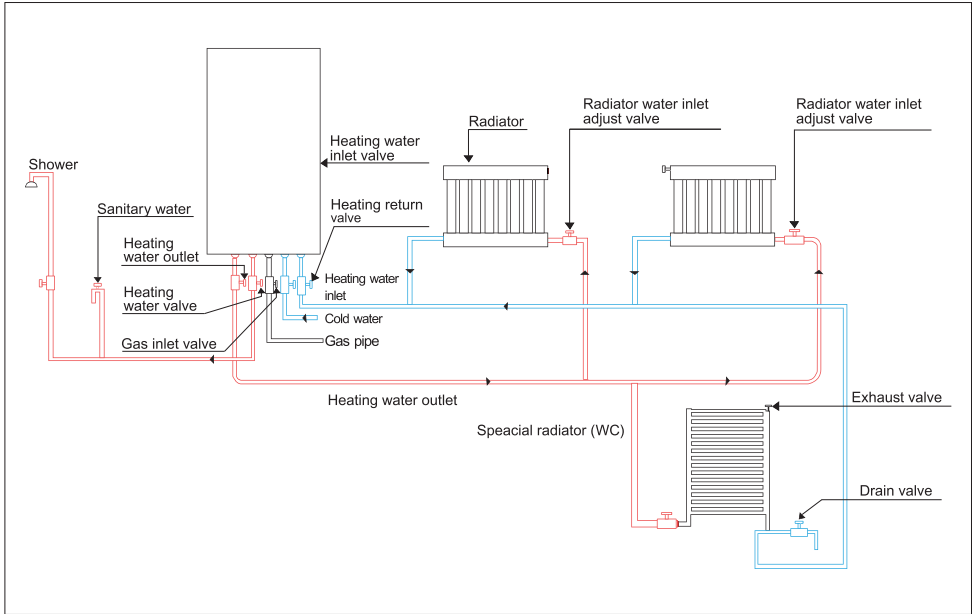

Be careful of high temperature surface



do not stack too many items



Keep away from flammable and explosive materials