

①  3*14= 4pcs

②  6*40=8pcs

③  4pcs

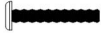
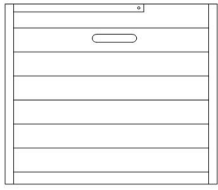

A

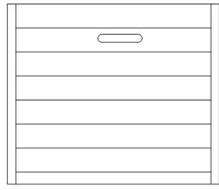

B

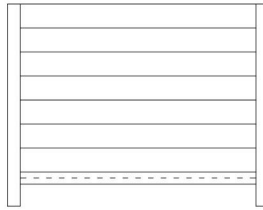

C

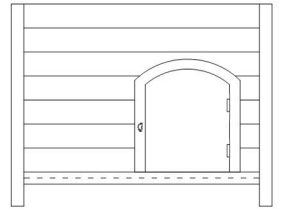

D



E

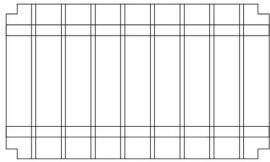

F

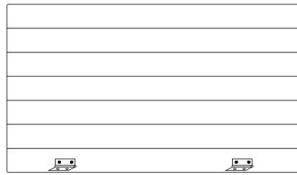

G

step1

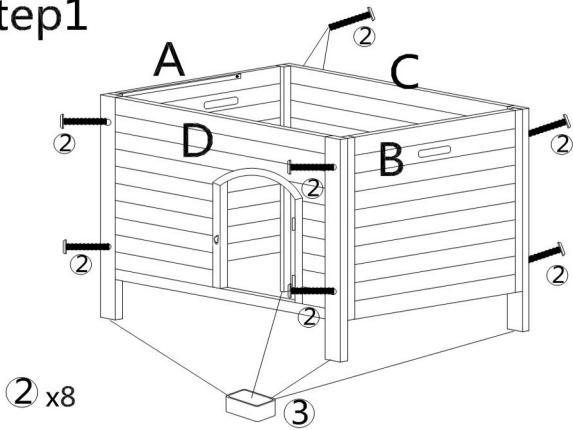

step2

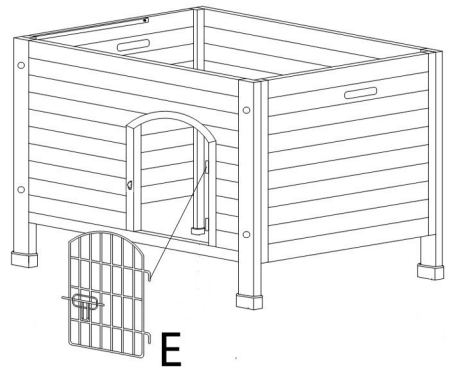

step3

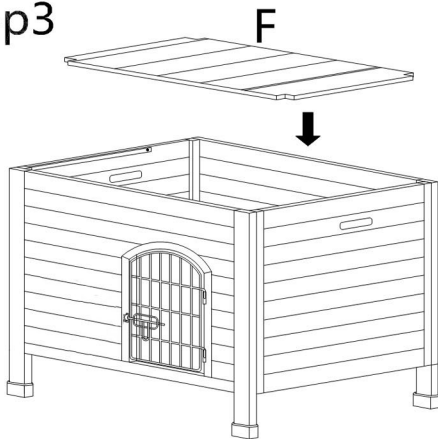

step4

