

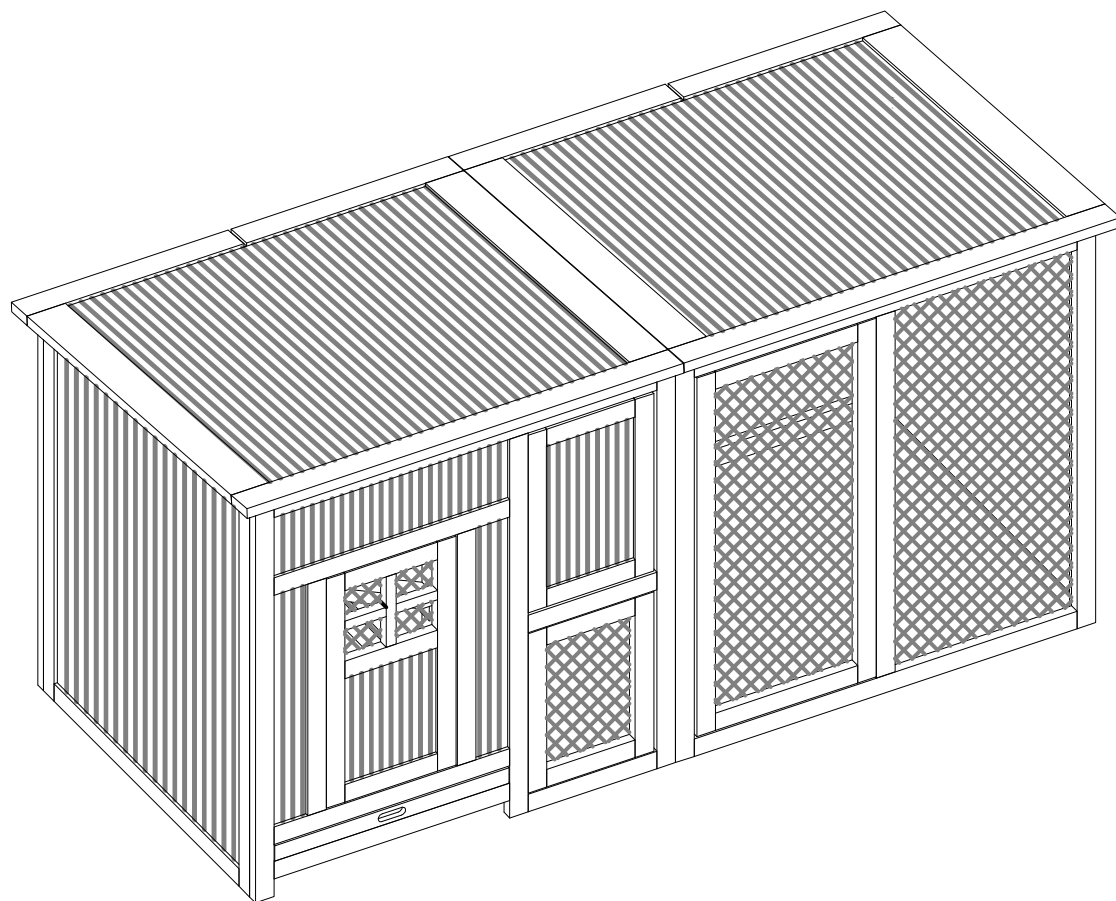









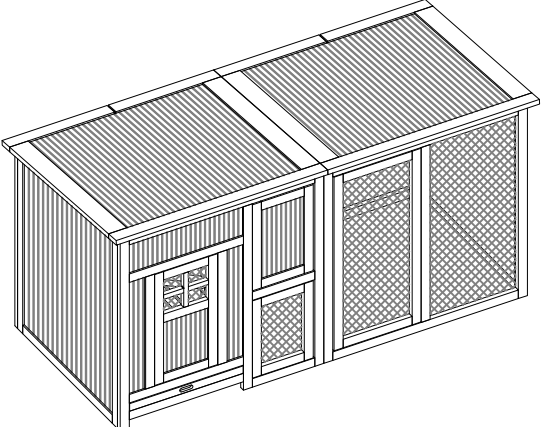
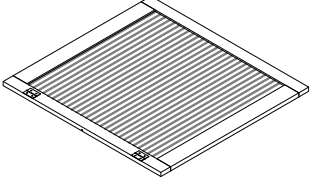
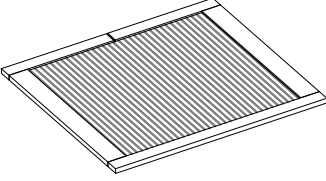
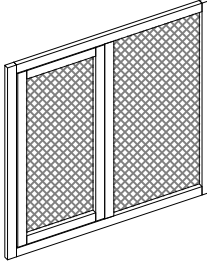
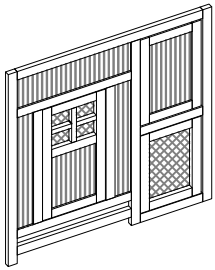
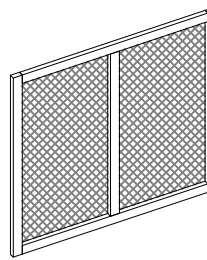
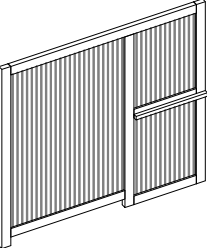
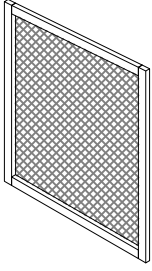
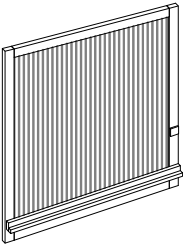

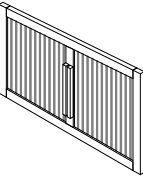
PawHut®

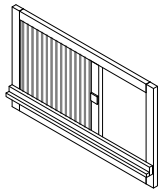
D51-104

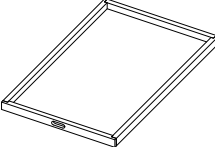

Please read these instructions and warranty information carefully before use and keep them properly for future reference.

OPERATING INSTRUCTIONS

| | | | | | |
|--|---|-----|----|--|-------|
|  | | | 8 |  | 1pc |
| | | | 9 |  | 1pc |
| | | | 10 |  | 1pc |
| 1 |  | 1pc | 11 |  | 1pc |
| 2 |  | 1pc | 12 |  | 1pc |
| 3 |  | 1pc | 13 |  | 1pc |
| 4 |  | 1pc | 14 |  | 1pc |
| 5 |  | 1pc | A |  3*16 | 8pcs |
| 6 |  | 1pc | B |  3.5*35 | 20pcs |
| 7 |  | 1pc | C |  3.5*45 | 2pcs |
| | | | D |  3.5*60 | 4pcs |
| | | | E |  | 1pc |

1

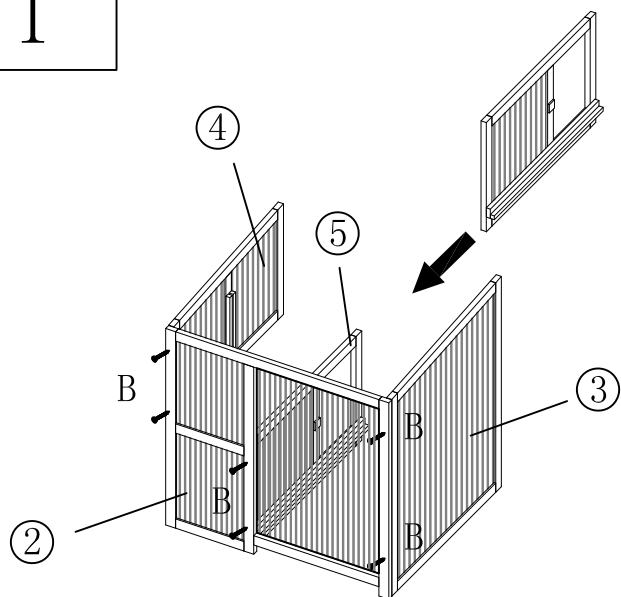

2

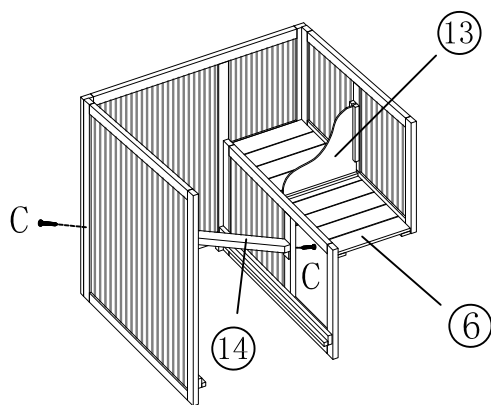

3

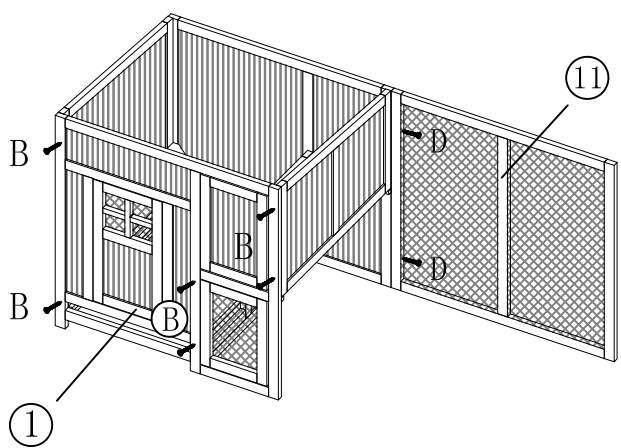

4

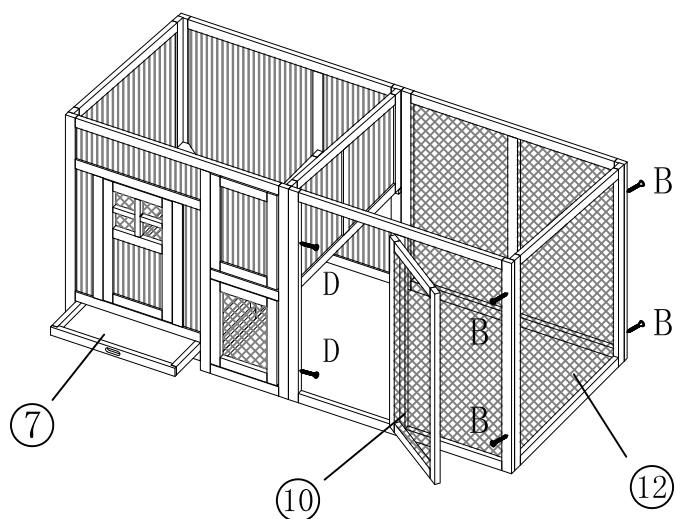

5

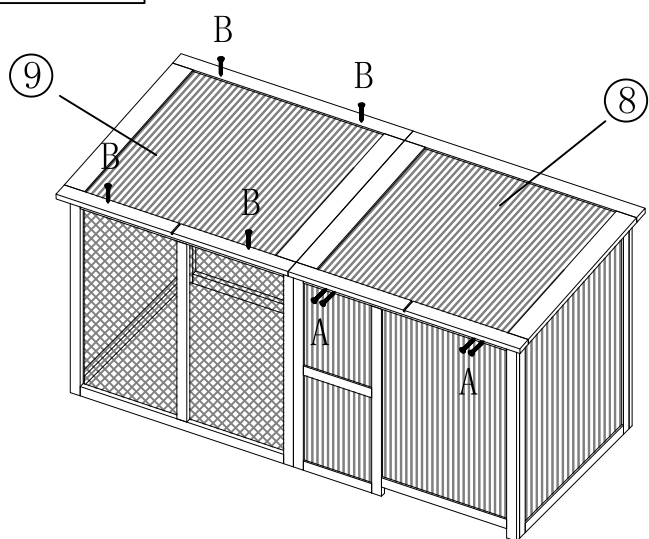

6

